

Question 1 Basic principle concerning representations of designs

Question 1-1 In the laws, regulations, examination guidelines, etc., of your country, there are provisions concerning the disclosure of designs. What is the underlying principle behind those provisions that determines the extent of disclosure of designs? In other words, when determining the extent of disclosure of designs, what are the primary goals of your country?

Example answers are listed below. Please give us a detailed answer.

- To facilitate formality examination or substantive examination.
- To facilitate storage of the submitted representations (drawings, photographs, specimens, etc.).
- To reduce the burdens on the users of the design system.
- To facilitate understanding of third parties (those other than design applicants and design holders)
- To facilitate the enforcement of rights.
- To ask for self-responsibility of the applicant who discloses his/her design.

Answer Section 1-1 (Provided by examiner in Design Department of SIPO)

To facilitate understanding of third parties (those other than design applicants and design holders)

第三者（意匠出願人／権利者以外の者）の理解を容易にするため

Question 1-2 In many cases, designers design industrial products by using 3D CAD and CG software. Does your country allow design applicants to use the 3D CG images created in the stage of product design such as those shown below as design representations to be included in design application documents?

[Article which constitutes the Design] Attachable wash-basin

[International Design Classification] 23-02

[Description of the Article which constitutes the Design] This design will be used mostly by medical staff to wash their hands in medical facilities, etc.

[Description of the Design] Each drawing was created using computer graphics software. The shading applied to the entire surface of the 3D configuration presented in each drawing shows the shape of the curved surface.

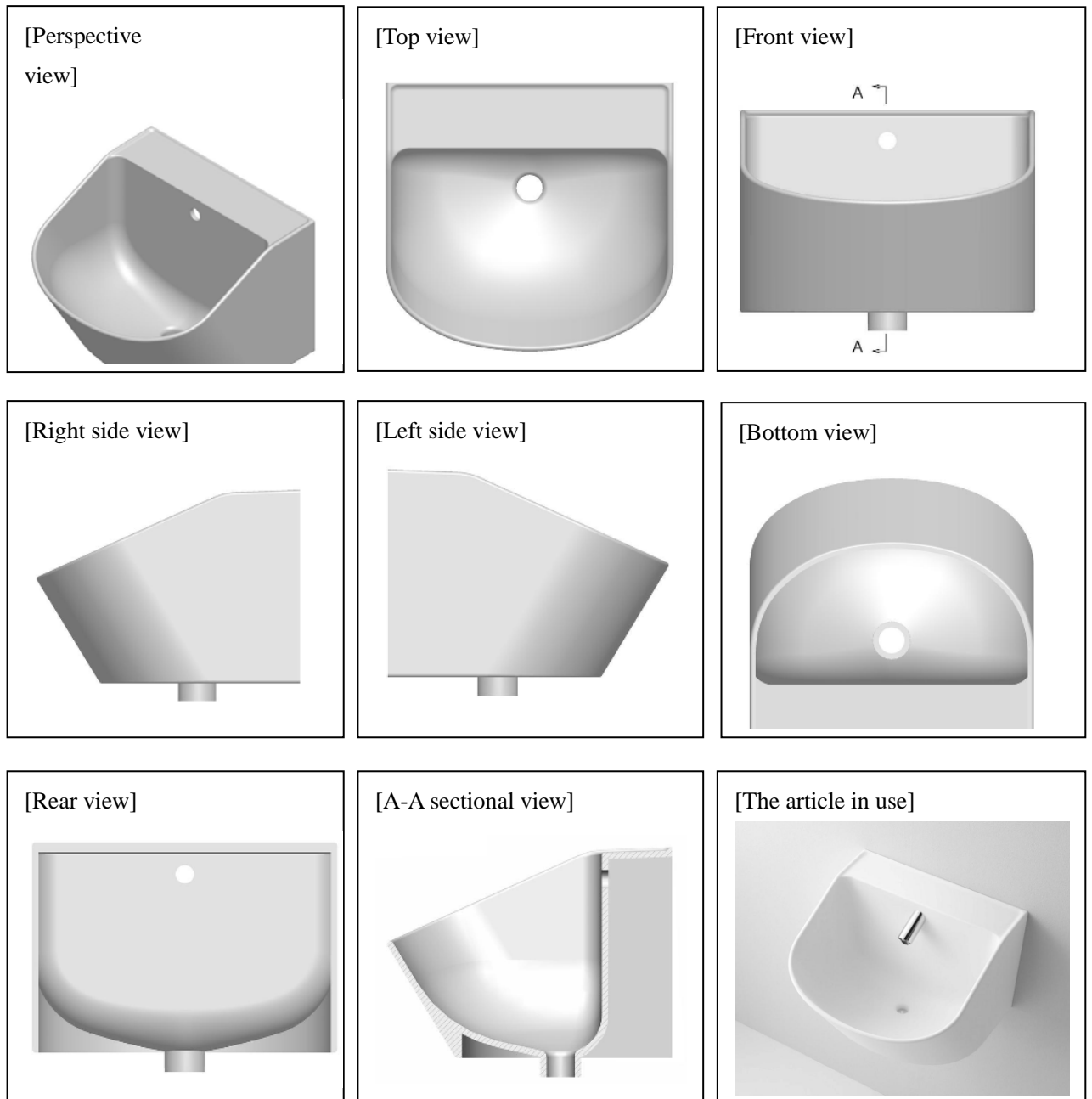

Japan Design Registration No. 1442550

Answer Section 1-2 (Provided by examiner in Design Department of SIPO)

Design applicants can use the 3D CG images.

意匠出願人は、3D の CG 画像を使用できる。

Question 2 Representations of designs under the system to protect the design of a part of an article (partial design system)

Question 2-1 This is a question to the IP Office of any country that has either a partial design system or a system to protect the design of a part of an article. If you are representing the IP Office of any country that has neither of these systems, please skip this question and answer Question 2-2.

Two specific examples of representations of partial designs are given below. In the case of Example 1, an applicant seeking protection for a partial design used a different color to distinguish the partial design from the rest of the article. In the case of Example 2, an applicant seeking protection for a partial design used a different line (broken line) to distinguish the partial design from the rest of the article. Does your country allow such representations of partial designs? Please tell us whether and why each of the following two methods shown in the following examples is permitted or not?

(Example 1) A case where an applicant seeking protection for a partial design used a different color to distinguish the partial design from the rest of the article

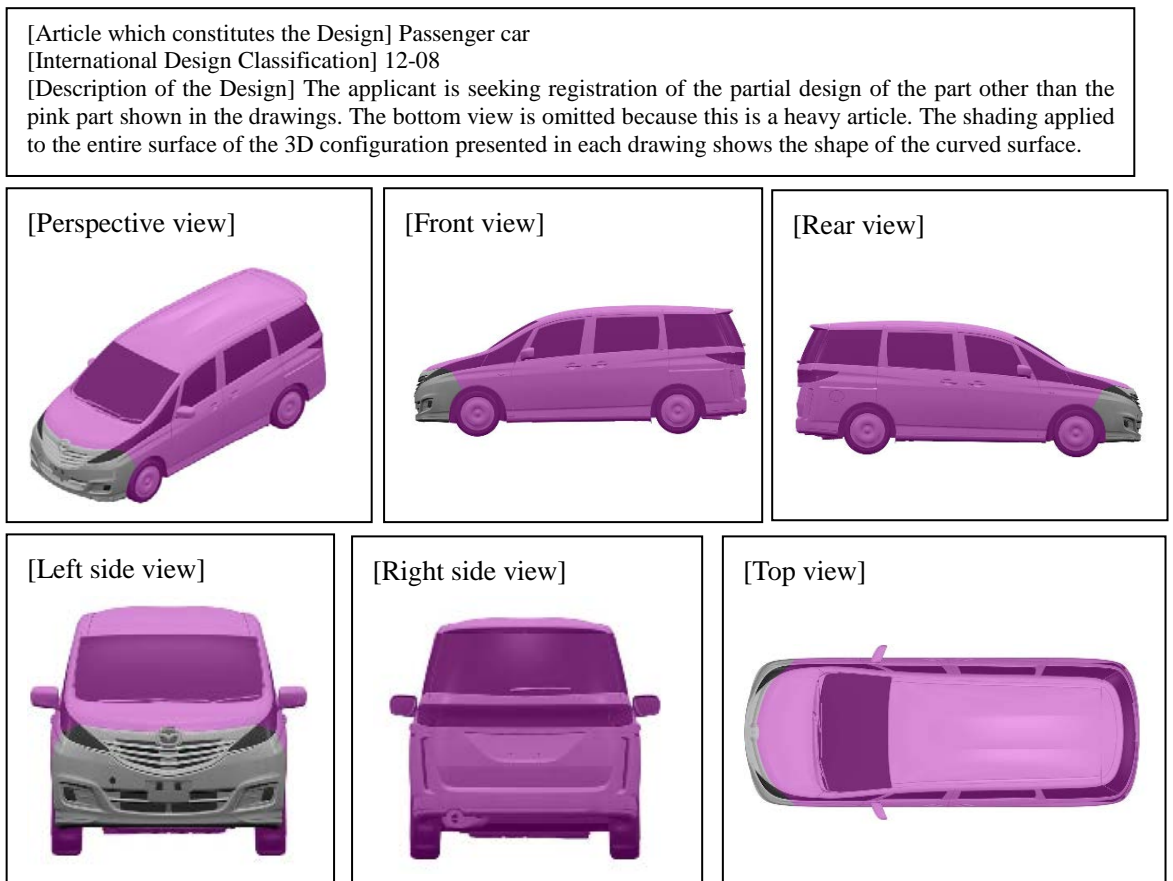

Japan Design Registration No. 1444223

(Example 2) A case where an applicant seeking protection for a partial design used a different line to distinguish the partial design from the rest of the article

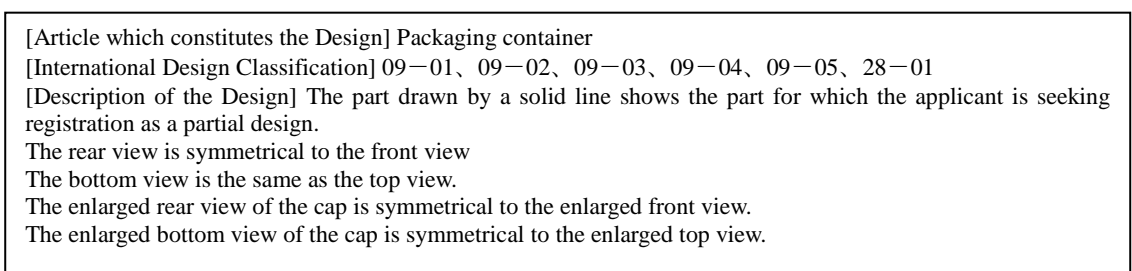

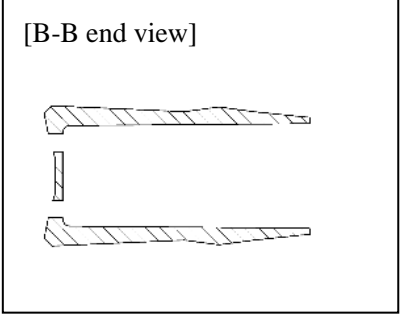
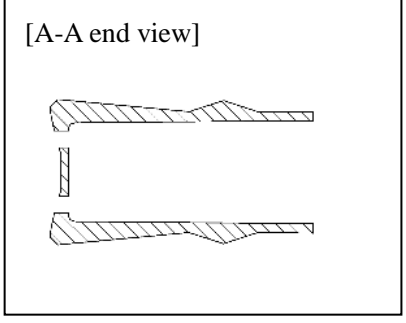
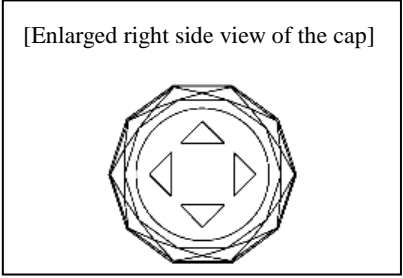
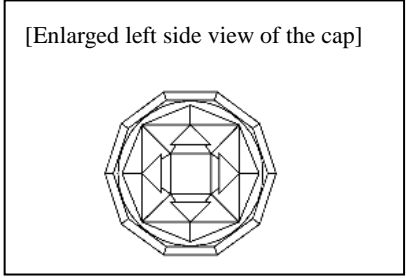
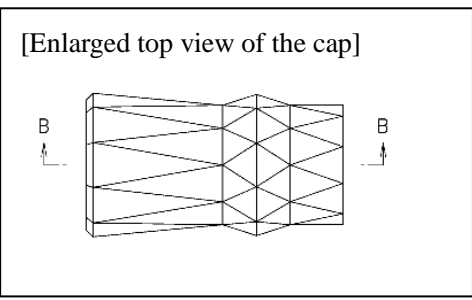
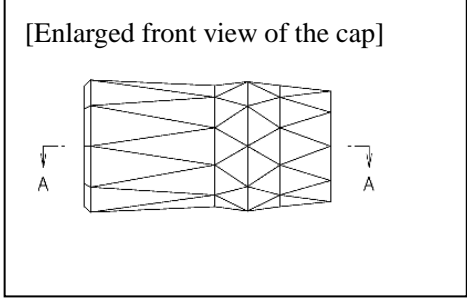
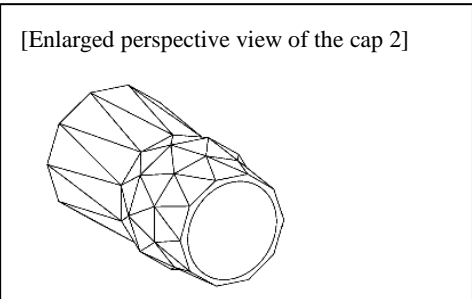
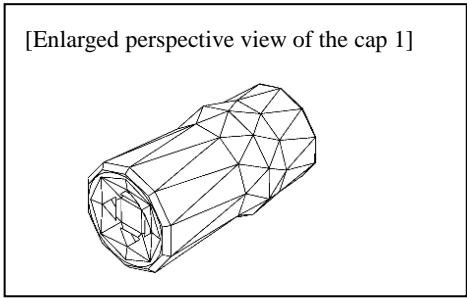
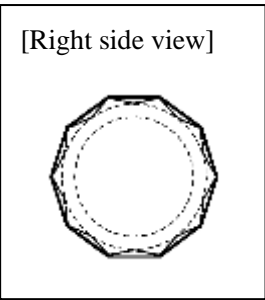
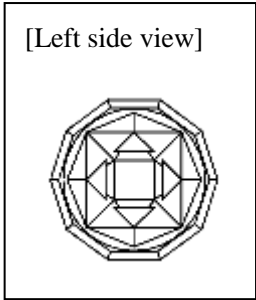
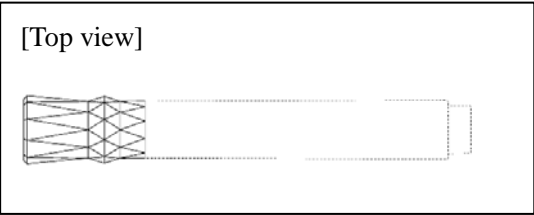
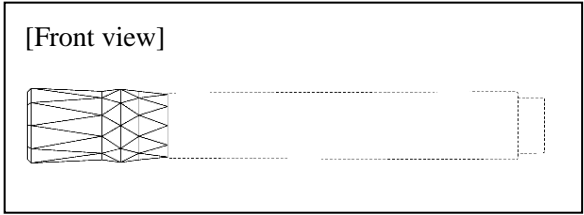

Answer Section 2-1

Question 2-2 This is a question to the IP Office of any country that has neither a partial design system nor a system to protect the design of a part of an article. If you are representing the IP Office of any country that has either of these systems, please skip this question and answer Question 3.

Do the users of the design system of your country request protection for the partial designs of articles? For example, is there a need for the establishment of a partial design system, which is an effective countermeasure against infringers of partial designs who copy only a unique and innovative part of an article without copying the design of the article as a whole?

Answer Section 2-2 (Provided by examiner in Design Department of SIPO)

Yes, We do have a need for the establishment of a partial design system.

部分意匠制度のニーズはある。

Question 3 The policy of conducting to find designs

Please answer this question regardless of whether your country has adopted a system that conducts only formality examination before registration, a system that conducts both formality examination and substantive examination before registration, or a system that conducts formality examination on all applications and conducts substantive examination only on certain applications before registration.

Question 3-1 In the course of formality examination on the design claimed in an application, to what extent do you conduct to find the design? Example answers are listed below. Please give us a detailed answer.

- We examine whether an application satisfies the prescribed formality requirements such as the number, sizes, etc., of the submitted drawings or photographs but do not examine the design in further detail.
- In addition to whether a design satisfies the formality requirements, we conduct to find out whether the design is disclosed in accordance with the relevant regulations by taking into consideration the article that embodies the design and checking the drawings, photographs, etc., submitted by the applicant.
- If we conduct to find design and determine that the design fails to satisfy the substantive

requirements for design registration (e.g., the case where the design clearly lacks novelty), we conduct substantive examination as well

Answer Section 3-1 (Provided by examiner in Design Department of SIPO)

In addition to whether a design satisfies the formality requirements, we conduct to find out whether the design is disclosed in accordance with the relevant regulations by taking into consideration the article that embodies the design and checking the drawings, photographs, etc., submitted by the applicant.

形式的な要件に加え、意匠にかかる物品を考慮し、提出された図面あるいは写真等を精査して意匠を認定し、規定通りに意匠が開示されているかを判断する。

Question 3-2 Who conducts the formality examination mentioned in Question 3-1? Is it conducted by a formality examiner, Office staff member, or any other staff member (including a substantive examiner)? Please specify.

Answer Section 3-2 (Provided by examiner in Design Department of SIPO)

Only the formality examiner.

方式審査官のみ

Question 3-3 Do you have a system to invalidate a registered design right on the grounds that the design is unclear for such reasons as the design right having an unidentifiable scope? Example answers are listed below. Please give us a detailed answer.

- System to file a request with the IP Office for commencement of examination
- System to file a request with the IP Office for an invalidation trial
- System to file a lawsuit with a court

Answer Section 3-3 (Provided by examiner in Design Department of SIPO)

We gave a system to file a request with the IP Office for an invalidation trial.

知的財産担当官庁に対する無効審判の請求制度がある。

Question 3-4 Is there any judicial precedent where the clarity of a design representation was at issue? If yes, please summarize the judgment and tell us the grounds on which the court found the design representation to be unclear.

Answer Section 3-4 (Provided by examiner in Design Department of SIPO)

Yes, there are.

If the content of the drawings or photographs of a design patent has defects that cause the uncertainty of the protection target of design, it may be excluded from the patent protection under Article 27.2 of the Patent Law of China.

ある。意匠特許の図面または写真の内容に瑕疵があり、それによって意匠の保護対象が不明確な場合は、専利法第 27.2 条に基づき、特許保護が受けられない可能性がある。

Question 4 Principle concerning amendments

Question 4-1 Is it permitted to amend a design application? If yes, what restrictions are imposed on an amendment in terms of time schedule and content? Please tell us any restrictions imposed on an amendment in practice other than those specified in the laws, regulations, examination guidelines, etc., that we should know about. Furthermore, is it permitted to make a voluntary amendment?

Answer Section 4-1 (Provided by Linda LIU & Partners)

Yes, it is permitted to amend a design application. Amendments can be made according to the examiner's request or initiatively by the applicant.

可能。意匠出願の補正は認められる。補正は審査官の要求により、または出願人が自発的に行うことができる。

After receiving the official notification from SIPO, the applicant can make amendments to the defects that indicated by the examiner within the designated time limit, usually within 2 months from receiving the notification. (Rule 44 of the Implementing Regulations of the Patent Law of China)

SIPO から通知を受けた場合、出願人は、指定された期限（通常は 2 カ月）内に、審査官が指摘した瑕疵を補正することができる（専利法実施細則第 44 条）。

Voluntary amendments to the drawings/ photographs or explanation of the design can be made within two months from the filing date. (Rule 51.1 of the Implementing Regulations of the Patent Law of China)

図面／写真または意匠の説明に対する自発的な補正は、出願日から 2 カ月以内に行うことができる（専利法実施細則第 51.1 条）。

All the amendments may not go beyond the scope of the disclosure as shown in the initial drawings or photographs. (Article 33 of the Patent Law of China)

すべての補正は、最初の図面や写真による開示の範囲を超えてはならない（専利法第 33 条）。

Question 4-2 What may be submitted to make an amendment? Please tell us what may be submitted in practice other than those specified in the laws, regulations, examination guidelines, etc.

Answer Section 4-2 (Provided by examiner in Design Department of SIPO)

To make an amendment, the applicant shall submit rectification with the signature or seal on it, and the corresponding replacement sheet of the amended documents.

補正を行うには、出願人は、署名または捺印した修正（rectification）、および補正する書類の差替えを提出しなければならない。

Question 4-3 If the IP Office refuses to accept any amendment made in response to an amendment order or made voluntarily, what action would the IP Office take? Is there a possibility that the IP Office dismisses the design application? Or, if only a minor defect is involved, would the IP Office accept amendment and register the application which was amended?

Answer Section 4-3 (Provided by examiner in Design Department of SIPO and Linda LIU & Partners)

With regard to the amended documents which can not be accepted, the examiner shall issue the Office Action to notify the applicant that the amendment is not conformity with the provision of Article 33. If the amendment is still not in conformity with the provisions after the application makes observations or rectification, the examiner may make a decision of rejection according to the provisions of Article 33 of the Patent Law of China and Rules44.2 of the Implementing Regulations of the Patent Law of China.

認められない補正については、審査官がオフィスアクションによって、補正が第 33 条の規定に適合していないことを出願人へ通知する。出願人による意見または修正の提出後、補正が依然として規定に適合していない場合、審査官は、専利法第 33 条および専利法実施細則第 44.2 条に従って、拒絶の決定を行うことができる。

Yes, there is a possibility that the IP Office dismisses the design application.

意匠出願が却下される場合はある。

With regard to the amendment made two months later, if the amended documents overcome the defects existing in the initial application documents, and have the prospect of being granted the patent, the amended documents may be accepted.

2カ月後に行われた補正については、最初の出願書類に存在する瑕疵が、補正書類において解決されており、特許付与される見込みがある場合は、補正された書類を受理されると考えられる。

Question 4-4 Even though a design application is satisfied the formality requirements, are there any cases where the IP Office sends the applicant a instruction for an amendment related to a representation of the design in order to facilitate to conduct finding the design or to make the representation of the design more accurate? Please tell us what is stated in such a request in detail.

Answer Section 4-4 (Provided by examiner in Design Department of SIPO and Linda LIU & Partners)

Yes, there are many cases where the IP Office sends the applicant an instruction for an amendment related to a representation of the design, here, we just take the following two cases as the examples.

So far as the product with a three-dimensional design is concerned, if the essential features of the design of the product involve six side, the applicant shall submit orthographic projection of six side view; if the essential features of the design of the product involve the view of one side or several sides only, the applicant shall submit at least orthographic projection view and space diagram of the side concerned, and indicate the reason of the omission of the view in the brief explanation, if the above-mentioned views are not sufficient, the IP Office will send an instruction for an amendment. In addition, the relation of projection is wrong, for example, the relation of projection is not conformity with the rules of exact projection, corresponding projection relation among the views lacks, or the direction of the view is upside-down, so that the drawings or photographs may have more than one possibility to explain the design product, the IP Office can send the applicant an instruction for an amendment.

ある。知的財産担当官庁が意匠の表現に関する補正を促す通知をする場合は多いが、ここでは、例として以下の2つのケースを挙げるにとどめる。立体意匠に関し、意匠の本質的な特徴に6面が含まれる場合は、6面の正投影図を提出しなければならない。意匠の本質的な特徴が、1面またはいくつかの面のみの場合、少なくとも、その面の正投影図および空間図を提出し、

図を省略した理由を簡潔に示さなければならない。上述の図が不十分な場合、知的財産担当官庁は補正を促す通知を行う。また、投影の関係が間違っている場合、例えば、投影の関係が正確な投影の規則に従っていない場合、図どうしの対応する投影の関係がない場合、図が逆さまの場合など、図面や写真による意匠の説明に複数の可能性があるときも、知的財産担当官庁は補正を促す通知を行うことができる。

Question 4-5 In the case mentioned in Question 4-4, if the IP Office sends an instruction to an applicant, is the applicant required to make an amendment strictly in accordance with the instruction? Or, is the applicant permitted to make an amendment in the way he/she wishes to a certain extent? Please explain in detail.

Answer Section 4-5 (Provided by examiner in Design Department of SIPO)

The applicant is permitted to make an amendment in the way he/she wishes to, but the amendment may not go beyond the scope of the disclosure as shown in the initial drawings or photographs.

出願人は、本人が希望する形で補正を行うことが認められるが、補正は、最初の図面／写真における開示の範囲を超えてはならない。

Question 4-6 Is it permitted for a design applicant to divide the application and file a divisional application as a new design application? If we yes, what restrictions are imposed on the filing of a divisional application in terms of time schedule and content? Please tell us any restrictions imposed in practice other than those specified in the laws, regulations, examination guidelines, etc., that we should know about. For instance, is it permitted to divide a design application for a whole article and file a divisional design application for a new part or component?

Answer Section 4-6 (Provided by examiner in Design Department of SIPO and Linda LIU & Partners)

Yes, it is permitted to divide the application and file a divisional application as a new design application according to the Rule 42. The applicant shall file a divisional application no later than the expiration of two months from the date of receiving the Notification to Grant Patent Right to the initial application issued by the Patent Office. For example, the initial application wishes to protect a design of the whole product, and only submit the views of the whole product, in this case, the applicant is not allowed to take only part of the product out of the design as the subject matter of the divisional application. But if the initial application documents include some views of one part (except for the component part which can not

partitioned or sold and used independently), and these views can clearly represent this part, it is permitted to file a divisional application.

規則 42 に基づき、意匠出願を分割して新たな意匠出願とすることは認められる。分割出願は、特許庁が原出願に対して交付した特許権付与通知を受け取った日から 2 カ月以内に提出しなければならない。例えば、原出願が製品全体の意匠の保護を意図していて、製品全体の図のみを提出している場合は、その製品の一部のみを、分割出願の対象として取り出すことはできない。しかし、原出願書類に、製品の一部に関する図が含まれており（分割できない、あるいは単独で販売／使用できない構成部分を除く）、明らかにその部分を表す図である場合、分割出願を提出することが認められる。

Question 4-7 Before the according of the application filing date, is it necessary for the applicant to satisfy the requirements for representation of a design and a design should be found? Or, may the application filing date be accorded without finding a design as long as the formality requirements are satisfied (e.g., the number and size of drawings or photographs)?

Answer Section 4-7 (Provided by Linda LIU & Partners)

It is necessary for the applicant to satisfy the requirements for representation of a design and a design should be found.

意匠の表現の要件が満たされて、意匠の認定ができなければならない。

According the provisions of the Articles 27 and 28, where an application for a patent for design is filed, a request, drawings or photographs of the design and a brief explanation, the date on which the patent administration department under the State Council received the application shall be the date of filling. That is to say, once the applicant submits these documents, the filing date is determined.

第 27 条、第 28 条の規定によれば、意匠特許の出願は、特許出願書、当該意匠の図面または写真、および当該意匠の簡単な説明を提出し、国务院が出願を受領した日を出願日とする。つまり、出願人がこれらの書類を提出した時点で、出願日は決められる。

But in order to avoid extra procedures and fees caused by amendments after filing, or going beyond the scope of the disclosure as shown in the initial drawings or photographs, the drawings or photographs of the design should satisfy the requirements for representation of a design and a design should be found.

しかし、出願後の補正による追加的な手順や手数料の発生、あるいは最初の図面や写真による開示の範囲を超えることを防止するため、意匠の図面または写真は、意匠の表現の要件を満たして、意匠が認定できなければならない。

Question 4-8 In the case specified in Question 4-7, after an applicant makes an amendment in response to an order for amendment that the IP Office issued on the grounds that the requirements for according the application filing date were not satisfied, if said requirements are satisfied as a result of the amendment, which date does the IP Office accord as the application filing date, either the first application filing date or the date on which the amendment was submitted?

Answer Section 4-8 (Provided by Linda LIU & Partners)

After an applicant makes an amendment in response to an order for amendment that the IP Office issued on the grounds that the requirements for according the application filing date were not satisfied, even if said requirements are satisfied as a result of the amendment, the first application filing date is still the application filing date.

出願日認定の要件を満たしていないとして知的財産担当官庁から補正指令が出されて、出願人が補正応答した結果、出願日の認定の要件を満たした場合でも、最初に出願した日が出願日になる。

Question 4-9 In the case of an IP Office that conducts to find a design as a prerequisite for according the application filing date, please answer this question. In the case of any other IP Office, please skip this question and answer Question 5.

In the case mentioned in Question 4-8, if an amendment submitted to the IP Office changes the gist of the design, how would the amendment be treated? Would it be dismissed? Or, would it be deemed as a new application filed on the date on which the written answer to the order for amendment is submitted? Please explain in detail.

Answer Section 4-9

Question 5 Principle of unity

Question 5-1 Please tell us the requirements for representations of designs in order for multiple designs to be regarded as a single design.

Please give us a detailed answer. For example, is it the case that the designs of articles that are used in a physically separated manner may be regarded as a single design as long as those designs are regarded as a set in terms of design (e.g., a set of stackable pans), that a set of similar designs may be regarded as a single design as long as those designs are similar to each other in terms of configuration¹, that the designs represented in a drawing in a physically separated manner may be regarded as a single design as long as those articles are used simultaneously (e.g., a pen and its cap), or that the designs of different articles may be regarded as a single design as long as they are used simultaneously (e.g., a stationary article and its base)? Which requirements, either formality requirements (formality examination) or substantive requirements (substantive examination), must be met in order to recognize multiple designs as a single design? If multiple designs are not regarded as a single design, how would the IP Office treat them?

(Example) In Japan, a design application would be dismissed (i) if the applicant states two or more classifications of articles in the section entitled "Article which constitutes the design" of an application, (ii) if the applicant presents drawings of two or more articles, or (3) in the case of an application for the design of a part of an article, if the application covers two or more physically separated parts. If an application is dismissed for any of the aforementioned reasons, the applicant may file a divisional application (substantive requirements).

Answer Section 5-1 (Provided by Linda LIU & Partners)

In China, two or more similar designs for the same product or two or more designs which are incorporated in products belonging to the same class and sold or used in sets may be filed as one application According to Article 31 of the Patent Law of China.,

専利法第 31 条によれば、中国では、同一製品における 2 以上の類似意匠、あるいは同一種類でかつセットで販売または使用される製品の 2 以上の意匠は、1 件の出願として提出することができる。

“products belonging to the same class and sold or used in sets” means “are customarily sold or used at the same time and the design of which have the same concept”.

「同一種類でかつセットで販売または使用される」とは、一般的に同時に販売または使用され、その意匠の概念が同じであることを意味する。

If the submitted designs satisfy the above requirements (Substantive requirements), it is permitted to be filed as one application. if not satisfy the above requirements, the examiner may ask the applicant to file a divisional application or delete the other designs.

提出された意匠が上記の要件（実体要件）を満たせば、1 件の出願として提出することが認められ、要件を満たさない場合、審査官が出願人に対して分割出願を提出するか、他の意匠を削除するよう求めることができる。

¹ “Configuration” means here that the shape, patterns or colors, or any combination thereof, of an article. The same shall apply hereinafter.

Question 5-2 This is a question to the IP Office of any country that protects images. If your country does not protect images, please skip this question and answer Question 6.

Please tell us the provisions concerning representations of drawings that are required to be made in order to have multiple images regarded as a single design. Which requirements, either formality requirements (formality examination) or substantive requirements (substantive examination), must be met in order to have multiple images regarded as a single design? If multiple images are not regarded as a single design, how would the IP Office treat them?

(Example) In Japan, multiple images may be regarded as a single design covering multiple images in the case where the image before a change and the image after the change are used in relation to the same function of an article as long as those two images are considered to be related to each other in terms of configuration. If multiple images are not regarded as a single design, the application would be dismissed on the grounds that multiple images should be regarded as multiple designs (substantive requirements).

Answer Section 5-2

Question 6 Scope of design protection

Question 6-1 Based on what definitions or ideas concerning the similarity of the configurations of designs do you determine the scope of design protection? Please give us any judicial precedent where the court presented its interpretation about how to interpret the scope of design protection from the perspective of configuration similarity, for example, whether the scope of design protection only covers almost identical designs or covers designs of different degrees of similarity (variations).

There is no specific definition or ideas concerning the similarity of the configurations of designs. The determination should be made according to the knowledge and cognitive capability of a normal consumer, and the comparison of designs shall be made through the approach of whole observation and comprehensive judgment rather than through observing parts or details of the designs.

意匠の形態類似に関する定義・概念はない。類似の判断は、一般的な消費者の知識および認識能力に基づいて行うべきであり、意匠の比較においては、部分や詳細ではなく、意匠全体を観察して、総合的な判断を行うべきである。

When making the determination, you should first determine whether the categories of the products are identical or similar. If they are identical or similar, you may then make a comparison between the two designs incorporated in the products. If they are not identical or similar, there is no need to make a comparison. If the categories of the products are identical or similar but the two designs incorporated in the products are different, you need to further analyze whether the difference(s) makes(make) a notable impact on the overall visual effect of the designs. If there is a notable impact, the two designs do not constitute similar designs. If no notable impact is made (e.g. the difference only lies in slight variations in some parts), the two designs will constitute similar designs.

判断の際はまず、製品の分類が同一または類似しているかどうかを判断すべきである。同一または類似している場合は、それらの製品の2つの意匠の比較を行う。同一でないか類似していない場合は、比較を行う必要はない。製品の分類が同一または類似していても、それらの製品の2つの意匠が異なる場合は、その相違が、意匠の全体的な視覚的影響に顕著な影響を及ぼすかどうか、さらなる分析をする必要がある。顕著な影響があれば、2つの意匠は類似した意匠ではない。顕著な影響がなければ（例：相違が、一部におけるわずかな変化のみの場合）、2つの意匠は類似した意匠である。

***Interpretation of the Supreme People's Court on Several Issues concerning the Application of Law in the Trial of Patent Infringement Dispute Cases* has the following provisions.**

「特許侵害紛争裁判における法律適用に関するいくつかの問題に対する最高人民法院の解釈」には以下のような規定がある。

Article 8: Where a design identical or similar to the patented design is used on the identical or similar categories of product, the People's Court should hold that the allegedly infringing design falls into “the scope of protection afforded by a design patent” prescribed in Article 59.2 of the Chinese Patent Law.

第 8 条：特許付与された意匠と同一または類似の意匠が、分類が同一または類似の製品に使用されている場合、人民法院は、被疑侵害意匠が、専利法第 59.2 条に定める「意匠特許による保護の範囲」に入ると見なすものとする。

Article 11: Whether designs are the same or similar by comprehensively considering design features of the patented design and the allegedly infringing design as well as the overall visual effect of the designs. However, the design features mainly determined by the technical effect of the product and those features that cannot affect the overall visual effect, such as the material and internal structures, shall not be taken into consideration.

第11条：意匠が同一または類似のものかどうかは、特許付与された意匠および被疑侵害意匠の特徴、さらには両者の全体的な視覚効果を総合的に判断する。ただし、主として製品の技術的效果によって決まる意匠の特徴や、全体的な視覚効果に影響を与えない特徴、例えば、材質や内部の構造などは、考慮に入れないものとする。

The following exerts greater influence to the overall visual effect:

- 1. The parts of products which are easy to be observed directly in normal use;**
- 2. The design features which distinguish the patented design from the existing designs.**

次のものは、全体的な視覚効果に大きな影響を与える。

1. 製品の通常の使用において、容易に直接観察できる部分
2. 特許付与された意匠を既存の意匠と区別する特徴

Where there is no difference in the overall visual effect between the allegedly infringing design and the patented design, the People’s Court should recognize them as the same. If there is no substantial difference in the overall visual effect between the allegedly infringing design and the patented design, the People’s Court should recognize them as similar.

被疑侵害意匠と特許付与された意匠との間で、全体的な視覚効果に差がない場合、人民法院は、両者が同一であると認めるべきである。また、被疑侵害意匠と特許付与された意匠との間で、全体的な視覚効果に大きな差がない場合、人民法院は、両者が類似していると認めるべきである。

Question 6-2 Please explain in detail how the scope of design protection is affected by the identity or similarity of articles or by the identity or similarity of the functions and use of articles. Please give us any judicial precedent where the court presented its interpretation as to how the scope of design protection is affected by these factors.

Answer Section 6-2 (Provided by Linda LIU & Partners)

No matter you are at the right-confirmation stage or the right-exercising stage, you should first determine whether the categories of articles are identical or similar, and then you may make a comparison between the designs of the articles.

権利確認の段階か、あるいは権利行使の段階かに関係なく、まず物品の分類の同一／類似を判断することで、それらの物品の意匠を比較することができる。

Products of similar categories refer to products that have similar use. For example, a toy and a tiny ornament are products of similar categories, because they have similar use. It should be noted that for products having multiple uses, if some of the uses are the same and some are not, they are regarded as products of similar categories.

分類が類似している製品とは、用途が類似した製品のことである。例えば、おもちゃと小型の装飾品は用途が似ているため、分類が類似した製品である。ただし、複数の用途がある製品どうしで、同じ用途とそうでないものがある場合、これらの製品は分類が類似していると見なす。

It is provided by Article 9 of the *Interpretation of the Supreme People's Court on Several Issues concerning the Application of Law in the Trial of Patent Infringement Dispute Cases* that the People's Court should determine whether products are within the similar or same category by considering their uses. To determine the use of a product can refer to the brief description, International Classification of Designs, the function of the product and other factors such as sale and actual use of the product.

「特許侵害紛争裁判における法律適用に関するいくつかの問題に対する最高人民法院の解釈」の第9条では、人民法院は、製品分類の同一／類似について、その用途を考えて判断すべきと規定している。製品の用途を判断する際は、国際意匠分類の要約記述書、製品の機能、また製品の販売や実際の用途など、その他の要因も参照することができる。

The comparison is conducted only when the products are within the similar or same category. If the products are not within the same category, the right cannot be exercised even if the designs are completely identical.

比較は、製品の分類が同一／類似の場合にのみ行う。製品の分類が同一でない場合は、仮に意匠がまったく同一であったとしても、権利は行使できない。

Question 6-3 Please explain in detail how the scope of design protection is affected by the parts of an article that are not represented in drawings or photographs.

Answer Section 6-3 (Provided by examiner in Design Department of SIPO)

Where a view of the product incorporating the design is omitted, the applicant shall generally indicate the reason of the omission of the view, such as a view is omitted because it is symmetrical or identical with another view; if it is hard to indicate the reason, may only indicate the view which is omitted, for example, a large-scale apparatus lacks bottom view, it may be describe as “bottom view is omitted”. We may consider the parts of an article that are not represented in drawings or photographs as usual design.

意匠を含む製品の図を省く場合、通常は、対称図形のため省いた、あるいは別の図と同一のため省いたというように、省略の理由を示す必要があるが、理由を示すのが困難な場合は、省いた事実のみを示すこともでき、例えば、大型装置の底面図がない場合、「底面図は省略」のように示す。図面や写真で表されない物品の部分も、通常の意匠と見なすことができる。

Question 6-4 In the case of a design right for an article which partially changes to perform its functions, does the scope for design protection cover the configurations observed in the course of change? Or, does the scope of design protection cover only the configuration before a change and the configuration after the change?

The following is a specific example where a part of an article (toy) that has a three-dimensional configuration changes its configuration to perform its functions.

[Front view]



[Rear view]

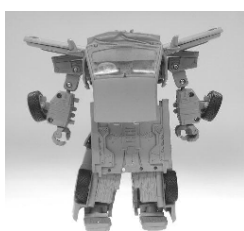

[Left side view]



[Right side view]

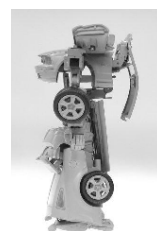

[Top view]



[Bottom view]



[Perspective view of the changing configuration]



[Front perspective view after the change]



[Rear perspective view after the change]



Answer Section 6-4 (Provided by examiner in Design Department of SIPO)

The scope for design protection covers the configurations observed in the course of change.
変化の過程における形態にも権利が及ぶ。

Question 6-5 This question is about the scope of design protection in the case of a set of articles or a certain set of articles. Does the design protection only cover a set of articles or a certain set articles? Or, does the design protection also cover each article that comprises a set?

If simultaneously used multiple articles are coordinated as a whole, the designs of those articles may be regarded as a single design. Such a design may be regarded as a "design for a set of articles." The term "a design for a certain set of articles" is conceptually the same as "a design for a set of articles." The term "a design for a certain set of articles" refers to a design used for any of the prescribed types of set.

Answer Section 6-5 (Provided by examiner in Design Department of SIPO)

The design protection only covers a certain set articles which are the same as products in set (Article 31 of the Patent Law of China). Products in set means that two or more products belonging to the same class, but independent from each other. The design concepts for the products are the same. Each product has its own independent value of use.

As each product has its own independent value of use, the design protection covers each article that comprises a set.

意匠保護は、同一の製品としてセットになっている物品のみに及ぶ（専利法第 31 条）。セットの製品とは、種類は同じだが、互いに独立している 2 つ以上の製品をいう。意匠の概念は同じだが、それぞれに独立した使用価値のある製品をいう。

製品ごとに独自の使用価値があるので、意匠保護は、セットを構成する各物品に及ぶ。

Question 6-6 This is a question about the restrictions on the exercise of design rights that are related to each other in conflict of which both right holders and both filing dates are deferent.

Design rights are considered to be related to each other in conflict in the following three cases:

- (i) a design right to protect the design of a whole article and a design right to protect the design of a component of the article (the component can be regarded as an independent article). Filing date of the design righth of a component of the article is earlier than filing date of the design right of a whole article. Both rights are owned by deferent persons;
- (ii) a design right to protect the design of a whole article and a design right to protect the design of a part of the article (a part means a portion of the article and cannot be separated as a component). Filing date of the design right of a part of the article is earlier than filing date of the design right of a whole article. Both rights are owned by deferent persons; and

(iii) a design right to protect the design of a set of articles or a certain set of articles and a design right to protect the design of any article that comprises a set. Filing date of the design right of any article that comprises a set is earlier than filing date of the design right of a set of articles or a certain set of articles. Both rights are owned by deferent persons.

For example, in Case (i) above, if the holder of a design right to protect the design of a whole article works the design or exercises the design right, is it sometimes necessary for him/her to obtain a license from the holder of a design right to protect the design of a component? How about the situations in Case (ii) and Case (iii) described above in terms of the restrictions on the exercise of design rights?

Answer Section 6-6 (Provided by examiner in Design Department of SIPO)

In Case (i), it is sometimes necessary.

In Case (ii), it is not necessary.

In Case (iii), it is sometimes necessary.

(i)では、必要な場合がある。

(ii)では、必要なし。

(iii)では、必要な場合がある。

Question 6-7 This is a question to the IP Office of any country that protects multiple images as a single design.

If your country does not protect multiple images as a single design, please skip this question and answer Question 7.

In the case of two related design rights, i.e., a design right to protect the designs of multiple images and a design right to protect the design of any of those images, are in conflict. Filing date of the design right of any of those images is earlier than filing date of the designs right of multiple images. Both rights are owned by deferent persons. In this case, are any restrictions imposed on the exercise of those design rights?

Answer Section 6-7

Question 6-8 This is a question to the IP Office of any country that protects multiple images as a single design and conducts substantive examination. If your country does not protect multiple images as a single design and does not conduct substantive examination, please skip this question and answer Question 7.

In case of an application seeking for a protection of a design of multiple images When filing date of an application seeking for a protection of design of any those images is earlier than filing date of an application seeking for a protection of a design of multiple images, and both applicants are different, what measures do you take when determining whether such a design has novelty and is not easily creatable by any person skilled in the art?

Answer Section 6-8

Question 7 Disclosure by drawings included in application documents and publication by gazettes

Question 7-1 Are there any cases where a drawing or photograph included in application documents is edited (e.g., altered in size or ratio) when the design is publicized in a design gazette (including an electronic gazette)? If editing is conducted, please tell us the reasons and standards for editing.

Answer Section 7-1 (Provided by examiner in Design Department of SIPO)

Yes, there are. If the scale of various views is not the same, and it is caused by the scanning entry problem, then the editing is conducted, but only the ratio can be edited, not the content of the design.

ある。さまざまな図の尺度が同じでない場合、それがスキャナーからの取り込みが原因である場合は編集を行うが、編集できるのは比率のみであって、意匠の内容を編集することはできない。

Question 7-2 If a design application is filed by an electronic medium, do you store printed-out hardcopies of the representations of the design as the original documents in addition to the submitted electronic images of those representations? If yes, why?

Answer Section 7-2 (Provided by examiner in Design Department of SIPO)

No, we don't.

保管していない。

Question 7-3 Does the public have access to the documents (including electronic data) prepared in the course of design prosecution starting from the filing of a design application to the registration of the design? If yes, please tell us the inspection fee and conditions (to what extent is inspection permitted? Are there any documents that are not available for inspection?).

Answer Section 7-3 (Provided by examiner in Design Department of SIPO)

Any person may file a request with the Patent Office to consult or photocopy the file of the patent application for granted design. The inspection is for free. Until the announcement of the grant of patent right for design, the requester for consultation or photocopying is limited only to the applicant and agent thereof.

誰でも、登録された意匠の出願ファイルの参照または写しを、特許庁に対して請求できる。閲覧は無料である。意匠の特許権付与が発表されるまでは、参照または写しの請求者は、出願人およびその代理人に限定される。

Question 8 Do you receive any opinions from users of the design system such as a request for a revision of the design system in order to change the way of representing a design in a design application under the relevant laws, regulations, and examination guidelines of your country and to remedy the current situation where the way of representing a design differs from one country to another? If yes, please describe those opinions in detail.

Answer Section 8 (Provided by examiner in Design Department of SIPO)

Yes, we do.

We receive opinions such as submitting the drawings of a design application in 3DSMax format, so that the examiner can observe the product in all directions.

出されている。

審査官が製品をあらゆる方向から観察できるようにするため、意匠出願の図面を 3DSMax フォーマットで提出できるようにすべき、といった意見が寄せられている。

Question 9 In recent years, has the number of design applications been on the rise or on the decline?
What do you think has caused such increase or decrease?

Answer Section 9 (Provided by examiner in Design Department of SIPO)

The number of design applications has been on the rise.

I think the main reason is because of the outline of the national intellectual property strategy's announcement and the improvement of China's capacity to create.

意匠出願件数は増加傾向にある。

主な要因としては、国の知的財産戦略の概要が公表されたこと、中国の創作能力が向上したことなどがあると考えている。

Question 10 If your country has signed the Hague agreement, please answer this question. Did the number of design applications increase or decrease in your country before and after the signing of the Hague agreement?

Answer Section 10

Question 11 If your country has signed the Hague agreement, please skip this question and answer Question 12.

This is a question to the IP Office of any country that is planning to sign the Hague agreement. What are your purposes for signing the Hague agreement? Please describe your purposes in detail.

Answer Section 11 (Provided by examiner in Design Department of SIPO)

Hague agreement is an effective way to protect the design right for Chinese enterprises, especially for those companies who want to compete with other countries.

ヘーグ協定は、中国企業、とりわけ他国との競争を望んでいる企業にとって、意匠権を保護する効果的な手段である。

Question 12 Please answer this question if your country has signed the Hague agreement or is planning to do so. In order to sign the Hague agreement, did you have to make any alterations or adjustments to your country's system? Or, is your country planning to alter or adjust your country's system in the future?

Answer Section 12 (Provided by examiner in Design Department of SIPO)

Yes, we are planning to make some alterations or adjustments to our country's system in the future.

今後、わが国の制度を変更・調整する予定である。

[Request for information]

13 If your country has adopted a multiple design application system, please send us information on how an application and drawings should be prepared in order to file a multiple design application. We would appreciate if you could send us a sample application and a sample drawing that are available for disclosure (those with all the sections filled in with information as a sample). If such application and drawing are not available for disclosure, please send us a blank application form, etc., if possible.

Answer Section 13 (Provided by examiner in Design Department of SIPO)

In china, only two or more similar designs for the same product or two or more designs which are incorporated in products belonging to the same class and sold or used in sets may be filed as one application According to Article 31 of the Patent Law of China. We supply a blank sample application for your reference, the applicant just needs to add the numbers of designs on the portion indicated by red frame compared with the single application.

中国では、同一の製品における 2 以上の類似意匠、あるいは同一種類でかつセットとして販売または使用される製品の 2 以上の意匠のみを、専利法第 31 条に基づき、一件の出願として提出できる。ご参考のため、見本（空欄のもの）を添付する。単一出願との違いは、赤枠で囲った部分に、意匠の数を記入することのみである。

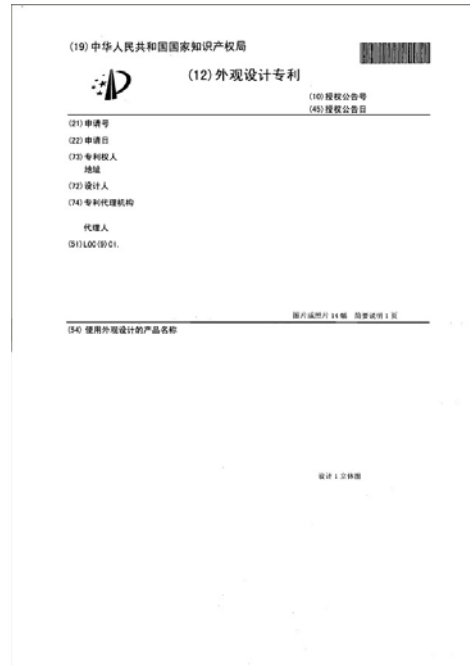

Question 1 Basic principle concerning representations of designs

Question 1-1 In the laws, regulations, examination guidelines, etc., of your country, there are provisions concerning the disclosure of designs. What is the underlying principle behind those provisions that determines the extent of disclosure of designs? In other words, when determining the extent of disclosure of designs, what are the primary goals of your country?

Example answers are listed below. Please give us a detailed answer.

- To facilitate formality examination or substantive examination.
- To facilitate storage of the submitted representations (drawings, photographs, specimens, etc.).
- To reduce the burdens on the users of the design system.
- To facilitate understanding of third parties (those other than design applicants and design holders)
- To facilitate the enforcement of rights.
- To ask for self-responsibility of the applicant who discloses his/her design.

Answer Section 1-1 (Provided by examiner in Design Department of SIPO)

To facilitate understanding of third parties (those other than design applicants and design holders)

第三者（意匠出願人／権利者以外の者）の理解を容易にするため

Question 1-2 In many cases, designers design industrial products by using 3D CAD and CG software. Does your country allow design applicants to use the 3D CG images created in the stage of product design such as those shown below as design representations to be included in design application documents?

[Article which constitutes the Design] Attachable wash-basin

[International Design Classification] 23-02

[Description of the Article which constitutes the Design] This design will be used mostly by medical staff to wash their hands in medical facilities, etc.

[Description of the Design] Each drawing was created using computer graphics software. The shading applied to the entire surface of the 3D configuration presented in each drawing shows the shape of the curved surface.

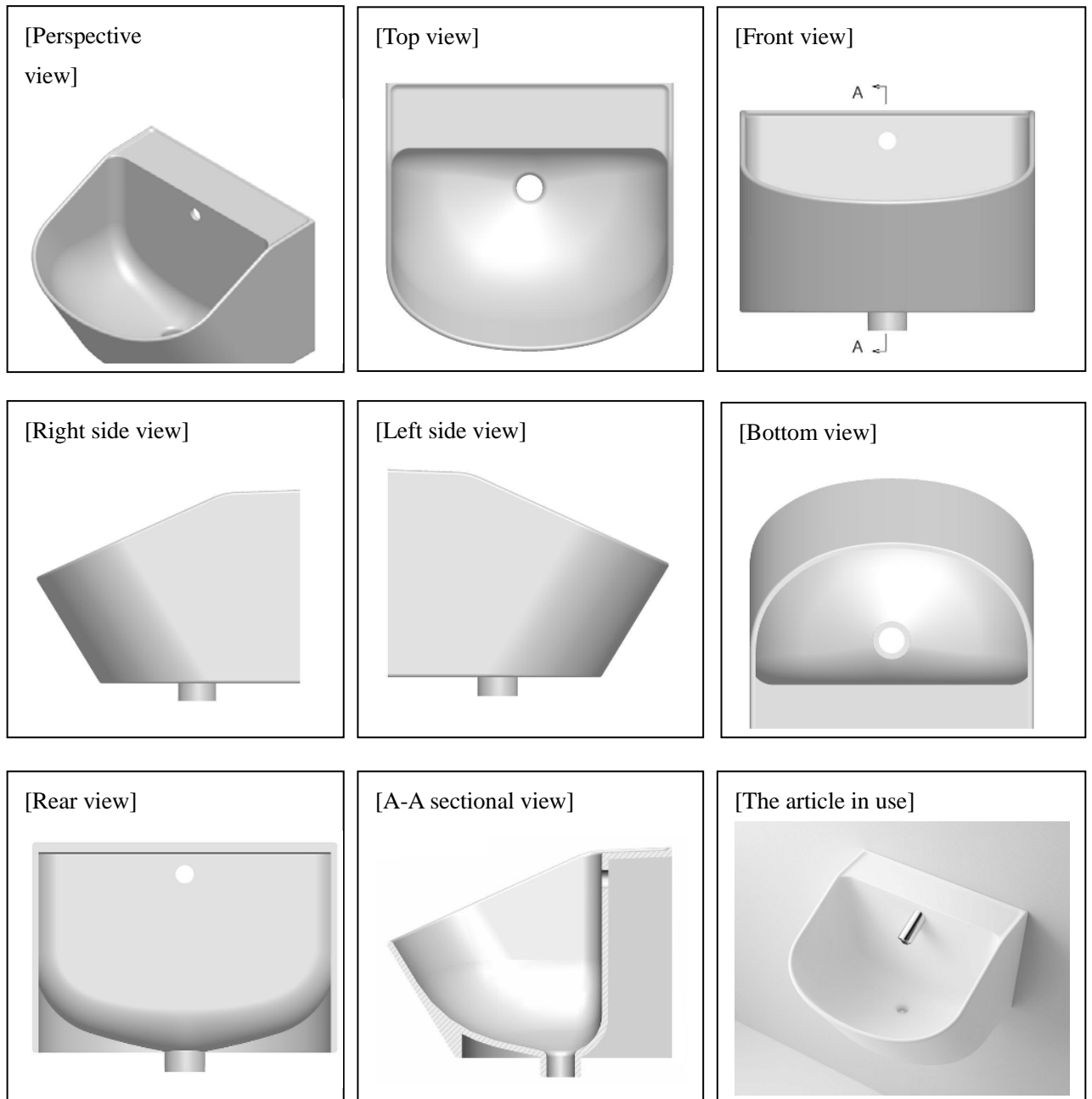

Japan Design Registration No. 1442550

Answer Section 1-2 (Provided by examiner in Design Department of SIPO)

Design applicants can use the 3D CG images.

意匠出願人は、3D の CG 画像を使用できる。

→■CG データを基本 6 面図（正投影図法）の図面にして出願したもの、との理解が良いですか（CG データ電子媒体は受け付けていないという理解でよいですか）。

■ その場合、3DCG データそのものの出願を認める予定は検討していますか。

Answer: Your understanding is correct. But It's hard to answer at this stage when we can use the 3D-CG directly. After all, the 3D-CG data is not widely used in the application document of other countries.

回答：その理解でよいが、現段階で、いつ3D-CGデータそのものを使用できるようになるかを言うのは難しい。いずれにしても、3D-CGデータは他国の出願書類において、広く使用されているわけではない。

Question 2 Representations of designs under the system to protect the design of a part of an article (partial design system)

Question 2-1 This is a question to the IP Office of any country that has either a partial design system or a system to protect the design of a part of an article. If you are representing the IP Office of any country that has neither of these systems, please skip this question and answer Question 2-2.

Two specific examples of representations of partial designs are given below. In the case of Example 1, an applicant seeking protection for a partial design used a different color to distinguish the partial design from the rest of the article. In the case of Example 2, an applicant seeking protection for a partial design used a different line (broken line) to distinguish the partial design from the rest of the article. Does your country allow such representations of partial designs? Please tell us whether and why each of the following two methods shown in the following examples is permitted or not?

(Example 1) A case where an applicant seeking protection for a partial design used a different color to distinguish the partial design from the rest of the article

[Article which constitutes the Design] Passenger car
[International Design Classification] 12-08
[Description of the Design] The applicant is seeking registration of the partial design of the part other than the pink part shown in the drawings. The bottom view is omitted because this is a heavy article. The shading applied to the entire surface of the 3D configuration presented in each drawing shows the shape of the curved surface.

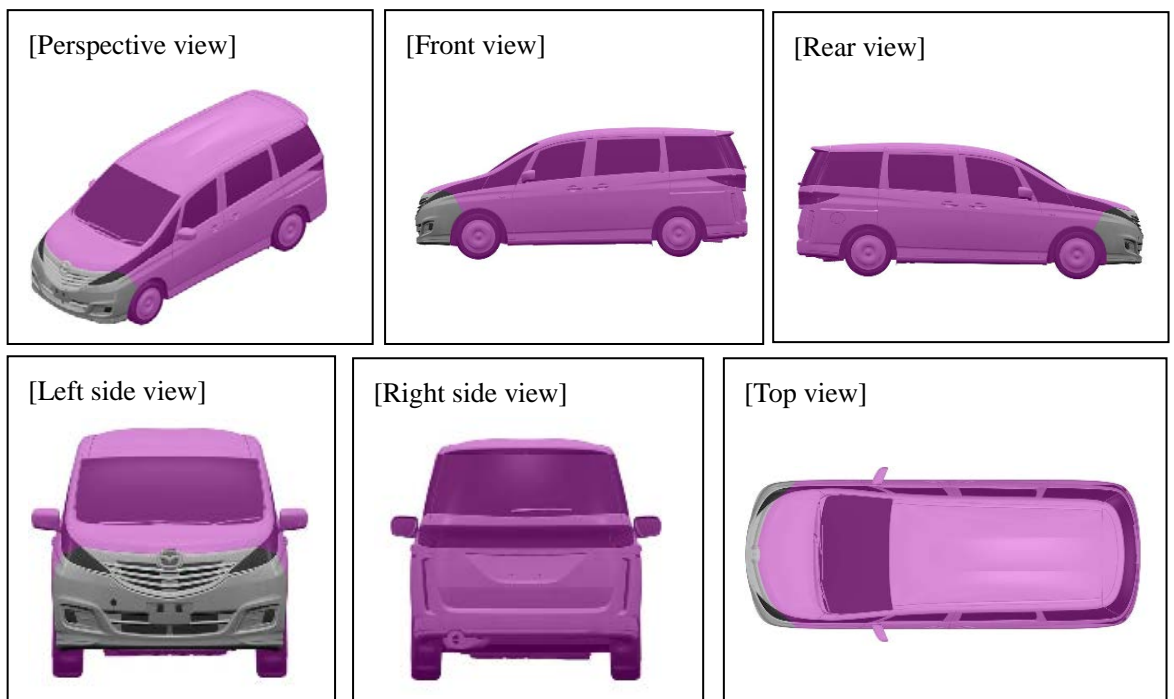

(Example 2) A case where an applicant seeking protection for a partial design used a different line to distinguish the partial design from the rest of the article

[Article which constitutes the Design] Packaging container

[International Design Classification] 09-01、09-02、09-03、09-04、09-05、28-01

[Description of the Design] The part drawn by a solid line shows the part for which the applicant is seeking registration as a partial design.

The rear view is symmetrical to the front view

The bottom view is the same as the top view.

The enlarged rear view of the cap is symmetrical to the enlarged front view.

The enlarged bottom view of the cap is symmetrical to the enlarged top view.

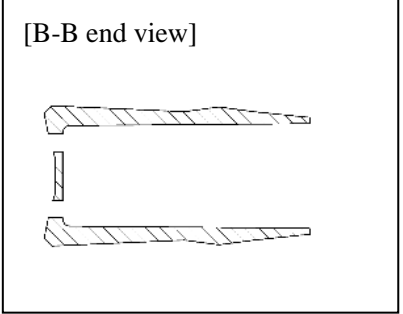
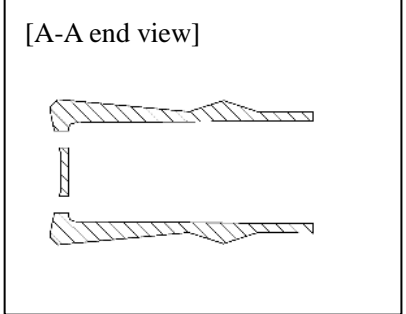
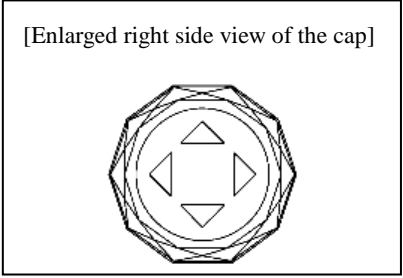
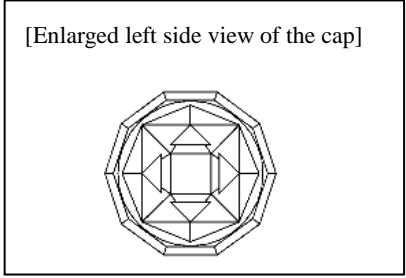
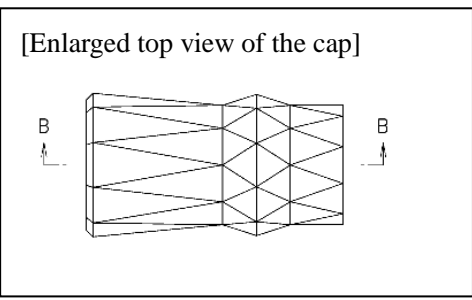
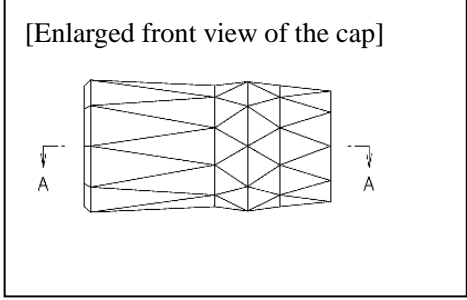
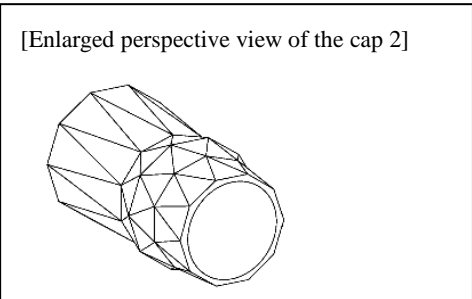
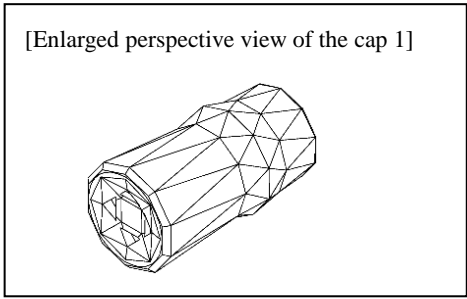
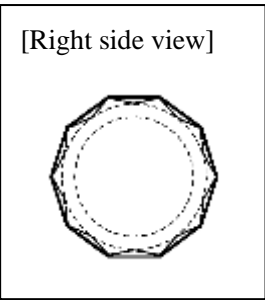
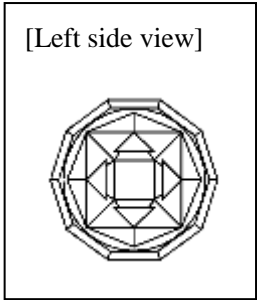
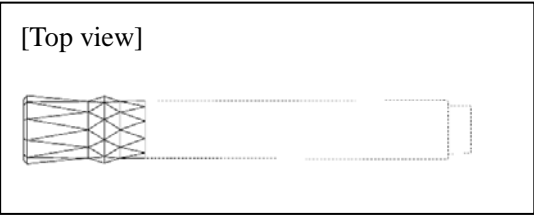
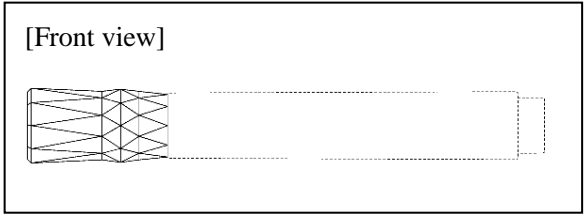

Answer Section 2-1

Question 2-2 This is a question to the IP Office of any country that has neither a partial design system nor a system to protect the design of a part of an article. If you are representing the IP Office of any country that has either of these systems, please skip this question and answer Question 3.

Do the users of the design system of your country request protection for the partial designs of articles? For example, is there a need for the establishment of a partial design system, which is an effective countermeasure against infringers of partial designs who copy only a unique and innovative part of an article without copying the design of the article as a whole?

Answer Section 2-2 (Provided by examiner in Design Department of SIPO)

Yes, We do have a need for the establishment of a partial design system.

部分意匠制度のニーズはある。

→■日本で部分意匠であった出願を優先権主張して中国に出願するときに部分意匠から全体意匠に直すことを許容していると聞いていますが間違いないですか。これについて審査指南やガイドラインに明記されていますか。

Answer:

Yes, it is true that we can submit a whole design claiming the priority of a partial design according to the practice, we only need to amend the dotted lines as the solid lines, but it is not explicitly specified in the Guidelines for Patent Examination.

回答：

その通りである。部分意匠の優先権を主張する全体意匠を提出することができ、点線を修正して実線にするだけでよいという運用が行われている。ただし、特許審査ガイドラインには明記されていない。

Question 3 The policy of conducting to find designs

Please answer this question regardless of whether your country has adopted a system that conducts only formality examination before registration, a system that conducts both formality examination and substantive examination before registration, or a system that conducts formality examination on all applications and conducts substantive examination only on certain applications before registration.

Question 3-1 In the course of formality examination on the design claimed in an application, to what extent do you conduct to find the design? Example answers are listed below. Please give us a detailed answer.

- We examine whether an application satisfies the prescribed formality requirements such as the number, sizes, etc., of the submitted drawings or photographs but do not examine the design in further detail.
- In addition to whether a design satisfies the formality requirements, we conduct to find out whether the design is disclosed in accordance with the relevant regulations by taking into consideration the article that embodies the design and checking the drawings, photographs, etc., submitted by the applicant.
- If we conduct to find design and determine that the design fails to satisfy the substantive requirements for design registration (e.g., the case where the design clearly lacks novelty), we conduct substantive examination as well

Answer Section 3-1 (Provided by examiner in Design Department of SIPO)

In addition to whether a design satisfies the formality requirements, we conduct to find out whether the design is disclosed in accordance with the relevant regulations by taking into consideration the article that embodies the design and checking the drawings, photographs, etc., submitted by the applicant.

形式的な要件に加え、意匠にかかる物品を考慮し、提出された図面あるいは写真等を精査して意匠を認定し、規定通りに意匠が開示されているかを判断する。

Question 3-2 Who conducts the formality examination mentioned in Question 3-1? Is it conducted by a formality examiner, Office staff member, or any other staff member (including a substantive examiner)? Please specify.

Answer Section 3-2 (Provided by examiner in Design Department of SIPO)

Only the formality examiner.

方式審査官のみ

→■具体的には、外観設計審査部の審査官ですか。現在の人員数は何人ぐらいですか。

Answer: About 210 examiners.

回答：約 210 名

Question 3-3 Do you have a system to invalidate a registered design right on the grounds that the design is unclear for such reasons as the design right having an unidentifiable scope? Example answers are listed below. Please give us a detailed answer.

- System to file a request with the IP Office for commencement of examination
- System to file a request with the IP Office for an invalidation trial
- System to file a lawsuit with a court

Answer Section 3-3 (Provided by examiner in Design Department of SIPO)

We gave a system to file a request with the IP Office for an invalidation trial.

知的財産担当官庁に対する無効審判の請求制度がある。

→■具体的には復審委員会における評価書のことですか。

Answer:

In practice, regarding a registered design, the public can file a request for invalidation with the Re-examination Board of SIPO (“復審委員会”), after examination, the Re-examination Board will issue a decision on whether the design right should be invalidated. During the examination, the Board will transfer the invalidation request to the patentee and give a chance for the patentee to make argument, and before making a decision, the Board may hold a Hearing for the parties to make further statements.

As for “評価書”, “the evaluation report of patent”, it is accomplished by the department of design examination” upon the request from the patentee or the interested party(ies).

回答：

登録意匠に関して、復審委員会に無効化を請求することができ、復審委員会は審査の後、意匠権を無効にすべきか否かの決定を行う。審査中、委員会は無効化請求を特許権者へ転送し、意見書を提出する機会を与えるとともに、決定の前に、当事者がさらなる陳述を行うための口頭審理を実施することもある。

評価書については、特許権者または利害関係者から請求があった場合に、意匠審査部門が作成する。

Question 3-4 Is there any judicial precedent where the clarity of a design representation was at issue? If yes, please summarize the judgment and tell us the grounds on which the court found the design representation to be unclear.

Answer Section 3-4 (Provided by examiner in Design Department of SIPO)

Yes, there are.

If the content of the drawings or photographs of a design patent has defects that cause the uncertainty of the protection target of design, it may be excluded from the patent protection under Article 27.2 of the Patent Law of China.

ある。意匠特許の図面または写真の内容に瑕疵があり、それによって意匠の保護対象が不明確な場合は、専利法第 27.2 条に基づき、特許保護が受けられない可能性がある。

→■権利化されたものの、復審若しくは裁判で意匠が不明確として権利無効となったケースはありますか。あれば例示をください（ヘアドライヤーの事例（2007 高行終審第 169 号）以外にあればご報告下さい）。

Answer:

As that indicated in the Invalidation decision No. 5097 (please see the attached), because the bottom view and the top view completely can not coincide completely and the front view and the right view can not coincide completely, so cause the uncertainty of the protection target of design we can not confirm the specific design based on all the views, that is to say, the uncertainty of the protection target of design.

回答：

無効審決第 5097 号（添付を参照）では、底面図と上面図が完全に一致せず、正面図と右側面図が完全に一致しないため、意匠の保護対象が不明確とされた。すべての図に基づいて、特定の意匠を確認できない、つまり、意匠の保護対象が不明確。

Question 4 Principle concerning amendments

Question 4-1 Is it permitted to amend a design application? If yes, what restrictions are imposed on an amendment in terms of time schedule and content? Please tell us any restrictions imposed on an amendment in practice other than those specified in the laws, regulations, examination guidelines, etc., that we should know about. Furthermore, is it permitted to make a voluntary amendment?

Answer Section 4-1 (Provided by Linda LIU & Partners)

Yes, it is permitted to amend a design application. Amendments can be made according to the examiner's request or initiatively by the applicant.

可能。意匠出願の補正は認められる。補正は審査官の要求により、または出願人が自発的に行うことができる。

After receiving the official notification from SIPO, the applicant can make amendments to the defects that indicated by the examiner within the designated time limit, usually within 2 months from receiving the notification. (Rule 44 of the Implementing Regulations of the Patent Law of China)

SIPO から通知を受けた場合、出願人は、指定された期限（通常は 2 カ月）内に、審査官が指摘した瑕疵を補正することができる（専利法実施細則第 44 条）。

Voluntary amendments to the drawings/ photographs or explanation of the design can be made within two months from the filing date. (Rule 51.1 of the Implementing Regulations of the Patent Law of China)

図面／写真または意匠の説明に対する自発的な補正は、出願日から 2 カ月以内に行うことができる（専利法実施細則第 51.1 条）。

All the amendments may not go beyond the scope of the disclosure as shown in the initial drawings or photographs. (Article 33 of the Patent Law of China)

すべての補正は、最初の図面や写真による開示の範囲を超えてはならない（専利法第 33 条）。

→■開示の範囲を超えているか否かを判断するのは誰ですか（Q4-3 回答によると、おそらく方式審査官と思われそうですが正しいでしょうか）

■ 2 ヶ月を超えて補正したらどうなりますか。手続却下でしょうか。

Answer:

1. Yes, it is determined by the preliminary examiner.

2. If an official notification of correction is issued, the applicant should make corrections or statements in this regard within the designated time limit (usually 2 months after receiving the notification). In case that the applicant fails to meet the time limit, the application will be deemed as being withdrawn.

If the applicant submits the Voluntary amendments beyond two months from the filing date, the examiner can refuse to accept it, but it would not be absolute. If this amendment has made to the problem of non-corresponding projection relationship, usually the examiner can accept it.

回答：

1. その通りであり、判断を行うのは、方式審査官（preliminary examiner）である。

2. 正式な修正の通知が出されたら、出願人は、これに関する修正書または陳述書を、指定された期間内（通常は、通知を受け取ってから 2 カ月後）に提出する必要がある。この期限に間に合わなければ、出願は取り下げられたものと見なされる。

出願人が、出願日から 2 カ月を過ぎてから自発的な補正を提出した場合、審査官は受理を拒否することができるが、絶対的なものではない。対応する投影の関係が正しくない場合に、このような補正を行った場合、通常であれば受理されると考えられる。

Question 4-2 What may be submitted to make an amendment? Please tell us what may be submitted in practice other than those specified in the laws, regulations, examination guidelines, etc.

Answer Section 4-2 (Provided by examiner in Design Department of SIPO)

To make an amendment, the applicant shall submit rectification with the signature or seal on it, and the corresponding replacement sheet of the amended documents.

補正を行うには、出願人は、署名または捺印した修正（rectification）、および補正する書類の差替えを提出しなければならない。

→■これについてのガイドラインはありますか。あれば教えてください。

Answer:

According to the provisions of 3.4 Chapter 3, Part I of the Guidelines for Patent Examination, when making corrections / rectifications to the application, the applicant should file a Request of Correction form and corresponding replacement sheet.

And according to the provisions of 8 Chapter 1, Part V of the Guidelines for Patent Examination, the documents submitted to the Patent Office shall be signed or sealed.

Moreover, Rule 52 of the Implementing Regulations of the Chinese Patent Law prescribes that “where an amendment to the drawings or photographs of an application for a patent for design is made, a replacement sheet shall be submitted as prescribed.”

回答：

特許審査ガイドラインの第 I 部第 3 章 3.4 の規定によれば、出願の修正／訂正を行う場合、出願人は修正申請書と、対応する差替え頁を提出する必要がある。

また第 V 部第 1 章 8 の規定によれば、特許庁へ提出する書類には、署名または捺印が必要である。

さらに、専利法実施細則第 52 条は、「意匠特許出願の図面又は写真の補正は、規定に基づいて差し替え頁を提出しなければならない」と規定している。

Question 4-3 If the IP Office refuses to accept any amendment made in response to an amendment order or made voluntarily, what action would the IP Office take? Is there a possibility that the IP Office dismisses the design application? Or, if only a minor defect is involved, would the IP Office accept amendment and register the application which was amended?

Answer Section 4-3 (Provided by examiner in Design Department of SIPO and Linda LIU & Partners)

With regard to the amended documents which can not be accepted, the examiner shall issue the Office Action to notify the applicant that the amendment is not conformity with the provision of Article 33. If the amendment is still not in conformity with the provisions after the application makes observations or rectification, the examiner may make a decision of rejection according to the provisions of Article 33 of the Patent Law of China and Rules 44.2 of the Implementing Regulations of the Patent Law of China.

認められない補正については、審査官がオフィスアクションによって、補正が第 33 条の規定に適合していないことを出願人へ通知する。出願人による意見または修正の提出後、補正が依然として規定に適合していない場合、審査官は、専利法第 33 条および専利法実施細則第 44.2 条に従って、拒絶の決定を行うことができる。

Yes, there is a possibility that the IP Office dismisses the design application.

意匠出願が却下される場合はある。

With regard to the amendment made two months later, if the amended documents overcome the defects existing in the initial application documents, and have the prospect of being granted the patent, the amended documents may be accepted.

2 カ月後に行われた補正については、最初の出願書類に存在する瑕疵が、補正書類において解決されており、特許付与される見込みがある場合は、補正された書類を受理されると考えられる。

■拒絶の決定と出願却下の違いは何でしょうか。

Answer: In this question, there is no difference between the two.

回答：この場合、両者に違いはない。

■拒絶後、及び出願却下後の救済措置はありますか（査定不服審判、出願却下についての審判／行政不服審判など）。

Answer: There is a remedy approach after rejection of the application. The applicant can file a request for reexamination with the Patent Reexamination Board within three months from the date of receipt of the Decision of Rejection.

回答：出願拒絶後の救済措置はある。出願人は、拒絶決定を受け取ってから 3 カ月以内であれば、復審委員会に対して再審査請求を提出できる。

■補正却下による審査の継続という考え方はないのでしょうか（※アンケート回答では、補正却下という回答がありました）。

Answer: Yes, but the prerequisite is that the applicant can convince the examiner. If the applicant cannot convince the examiner and insists on making no amendment, the examiner will again issue a Notification to Make Rectification. If the examiner has issued two Notifications to Make Rectification on the same defect and the applicant still makes no amendment, the application will be rejected.

回答：あるが、出願人が審査官を納得させられることが必要条件である。審査官を納得させることができず、かつ補正をしないと主張すれば、審査官は再度、修正の通知を行う。同一の瑕疵に関して通知が2回出され、出願人が補正を行わない場合、出願は拒絶される。

■提出期限を規定していながら、書類の内容によっては受理するというのは、運用レベルでの対応でしょうか。

Answer:

Yes, the amendment to the application documents should comply with Article 33 of the Chinese Patent Law, that is, the amendment to the application for a patent for design may not go beyond the scope of the disclosure as shown in the initial drawings or photographs.

回答：

その通りである。出願書類の補正は、専利法第33条を遵守する必要がある。すなわち、意匠特許出願の補正は、最初の図面や写真による開示の範囲を超えてはならないということである。

■日本では、H10年法改正において、図の瑕疵が軽微な場合、当該物品の業界に属している者が通常、単なる間違いと分かる範囲のものであれば、補正させることなく登録しています（そのような運用をとっています）。これに対し、中国ではどのように判断しているのでしょうか。

Answer:

In China, if the examiner finds that the projection relationship of one view is not corresponding to that of another view, the examiner usually will issue a Notification to Make Rectification and require the applicant to make an amendment; however, if the examiner does not find this defect, the application will be directly allowed. After the application is allowed, if another person files an invalidation request in accordance with Article 27.2 of the Chinese Patent Law (the views do not clearly indicate the design) and the Patent Reexamination Board judges that this is a minor flaw, the invalidation cause will usually not be accepted. In other words, if the allowed design only has a minor flow, it will not necessarily be invalidated.

回答：

中国では、ある図の投影の関係が、他の図に対応していないことを審査官が見つけた場合は通常、修正の通知を送付して、出願人に対して補正を促す。しかし、審査官がこの不備に気付かなかった場合、出願はそのまま認められる。出願が認められた後に、他者が専利法第 27.2 条（図が、意匠を鮮明に表示していない）に基づいて無効を請求し、復審委員会が軽微な瑕疵と判断すれば、無効の理由は認められない。つまり、受理された意匠に軽微な瑕疵があるだけでは、必ずしも無効にはならない。

Question 4-4 Even though a design application is satisfied the formality requirements, are there any cases where the IP Office sends the applicant a instruction for an amendment related to a representation of the design in order to facilitate to conduct finding the design or to make the representation of the design more accurate? Please tell us what is stated in such a request in detail.

Answer Section 4-4 (Provided by examiner in Design Department of SIPO and Linda LIU & Partners)

Yes, there are many cases where the IP Office sends the applicant an instruction for an amendment related to a representation of the design, here, we just take the following two cases as the examples. So far as the product with a three-dimensional design is concerned, if the essential features of the design of the product involve six side, the applicant shall submit orthographic projection of six side view; if the essential features of the design of the product involve the view of one side or several sides only, the applicant shall submit at least orthographic projection view and space diagram of the side concerned, and indicate the reason of the omission of the view in the brief explanation, if the above-mentioned views are not sufficient, the IP Office will send an instruction for an amendment. In addition, the relation of projection is wrong, for example, the relation of projection is not conformity with the rules of exact projection, corresponding projection relation among the views lacks, or the direction of the view is upside-down, so that the drawings or photographs may have more than one possibility to explain the design product, the IP Office can send the applicant an instruction for an amendment.

ある。知的財産担当官庁が意匠の表現に関する補正を促す通知をする場合は多いが、ここでは、例として以下の 2 つのケースを挙げるにとどめる。立体意匠に関し、意匠の本質的な特徴に 6 面が含まれる場合は、6 面の正投影図を提出しなければならない。意匠の本質的な特徴が、1 面またはいくつかの面のみの場合、少なくとも、その面の正投影図および空間図を提出し、図を省略した理由を簡潔に示さなければならない。上述の図が不十分な場合、知的財産担当官庁は補正を促す通知を行う。また、投影の関係が間違っている場合、例えば、投影の関係が正確な投影の規則に従っていない場合、図どうしの対応する投影の関係がない場合、図が逆さま

の場合など、図面や写真による意匠の説明に複数の可能性があるときも、知的財産担当官庁は補正を促す通知を行うことができる。

Question 4-5 In the case mentioned in Question 4-4, if the IP Office sends an instruction to an applicant, is the applicant required to make an amendment strictly in accordance with the instruction? Or, is the applicant permitted to make an amendment in the way he/she wishes to a certain extent? Please explain in detail.

Answer Section 4-5 (Provided by examiner in Design Department of SIPO)

The applicant is permitted to make an amendment in the way he/she wishes to, but the amendment may not go beyond the scope of the disclosure as shown in the initial drawings or photographs.

出願人は、本人が希望する形で補正を行うことが認められるが、補正は、最初の図面／写真における開示の範囲を超えてはならない。

→■補正での場合、例えば、使用状態図を参考として提出することや、断面図や展開図を追加することは、最初の開示の範囲を超えることになりますか。意匠の開示の範囲を変えずにこれらの図を追加することは可能でしょうか。

Answer:

Based on our experience, these views may be added without changing the scope of the disclosure of the design, but the basic principle is that these views should not go beyond the scope of the disclosure as shown in the initial drawings or photographs.

回答：

当方の経験では、それらの図は意匠の開示の範囲を変更することなく追加できるが、原則は、それらの図が、最初の図面／写真における開示の範囲を超えてはならないということである。

Question 4-6 Is it permitted for a design applicant to divide the application and file a divisional application as a new design application? If we yes, what restrictions are imposed on the filing of a divisional application in terms of time schedule and content? Please tell us any restrictions imposed in practice other than those specified in the laws, regulations, examination guidelines, etc., that we should know about. For instance, is it permitted to divide a design application for a whole article and file a divisional design application for a new part or component?

Answer Section 4-6 (Provided by examiner in Design Department of SIPO and Linda LIU & Partners)

Yes, it is permitted to divide the application and file a divisional application as a new design application according to the Rule 42. The applicant shall file a divisional application no later than the expiration of two months from the date of receiving the Notification to Grant Patent Right to the initial application issued by the Patent Office. For example, the initial application wishes to protect a design of the whole product, and only submit the views of the whole product, in this case, the applicant is not allowed to take only part of the product out of the design as the subject matter of the divisional application. But if the initial application documents include some views of one part (except for the component part which can not partitioned or sold and used independently), and these views can clearly represent this part, it is permitted to file a divisional application.

規則 42 に基づき、意匠出願を分割して新たな意匠出願とすることは認められる。分割出願は、特許庁が原出願に対して交付した特許権付与通知を受け取った日から 2 カ月以内に提出しなければならない。例えば、原出願が製品全体の意匠の保護を意図していて、製品全体の図のみを提出している場合は、その製品の一部のみを、分割出願の対象として取り出すことはできない。しかし、原出願書類に、製品の一部に関する図が含まれており（分割できない、あるいは単独で販売／使用できない構成部分を除く）、明らかにその部分を表す図である場合、分割出願を提出することが認められる。

→■分割された原出願はどのようになりますでしょうか。

Answer:

The examiner will continue to examine the original application after a divisional application is filed.

回答：

分割後の原出願を引き続き審査する。

■ 製品全体の図のみを提出している場合、パーツごとの図が当初から提出されていれば許容されるということでしょうか。

Answer:

Your opinion is correct. If the view of each component is filed on the filing date, a divisional application can be filed for the view of each component.

回答：

その理解でよい。パーツごとの図が出願日に提出されている場合は、そのパーツごとの図に関して、分割出願を行うことができる。

Question 4-7 Before the according of the application filing date, is it necessary for the applicant to satisfy the requirements for representation of a design and a design should be found? Or, may the application filing date be accorded without finding a design as long as the formality requirements are satisfied (e.g., the number and size of drawings or photographs)?

Answer Section 4-7 (Provided by Linda LIU & Partners)

It is necessary for the applicant to satisfy the requirements for representation of a design and a design should be found.

意匠の表現の要件が満たされて、意匠の認定ができなければならない。

According the provisions of the Articles 27 and 28, where an application for a patent for design is filed, a request, drawings or photographs of the design and a brief explanation, the date on which the patent administration department under the State Council received the application shall be the date of filing. That is to say, once the applicant submits these documents, the filing date is determined.

第 27 条、第 28 条の規定によれば、意匠特許の出願は、特許出願書、当該意匠の図面または写真、および当該意匠の簡単な説明を提出し、国务院が出願を受領した日を出願日とする。つまり、出願人がこれらの書類を提出した時点で、出願日は決められる。

But in order to avoid extra procedures and fees caused by amendments after filing, or going beyond the scope of the disclosure as shown in the initial drawings or photographs, the drawings or photographs of the design should satisfy the requirements for representation of a design and a design should be found.

しかし、出願後の補正による追加的な手順や手数料の発生、あるいは最初の図面や写真による開示の範囲を超えることを防止するため、意匠の図面または写真は、意匠の表現の要件を満たして、意匠が認定できなければならない。

→■例えば、出願時に、物品名、若しくは意匠の説明がない場合はどうなりますか。

Answer:

The application will not be accepted.

回答：

出願は受理されない。

■出願日を認定するための最低限の要件を教えてください。出願人名、創作者名、物品名、説明、図面、のどれか、もしくはすべてが揃った時点で出願日が特定されますか。

Answer:

Pursuant to Article 27 of the Chinese Patent Law, where an application for a patent for design is filed, a request, drawings or photographs of the design and a brief explanation of the design shall be submitted so as to determine the filing date. In addition, the Guidelines for Patent Examination, Part V, chapter 3 further prescribes the requirements for accepting a design application, i.e., (1) the request shall be included in the application documents, in which the type of patent application is clear, and the name or title and address of the applicant are indicated; (2) a brief description and drawings or photographs shall be included in the application documents; (3) the application documents are typewritten or printed in Chinese; the writing and lines of the application documents shall be legible, free from alterations and neat enough for the content of the document to be identified. Only after these requirements are met can a design application be accepted.

回答：

出願日の認定は、専利法第 27 条によれば、意匠特許出願を行う場合、出願書、当該意匠の図面又は写真、及び当該意匠の簡単な説明を提出しなければならない。さらに、特許審査ガイドライン第 V 部第 3 章では、次のような意匠出願の受理要件を規定している。(1) 出願書類には、出願書が含まれていること。出願書には、特許出願の種類が明確にされており、出願人の氏名／肩書き及び住所が記載されていること。(2) 出願書類には、簡単な説明及び図面又は写真が含まれていること。(3) 出願書類は中国語でタイプ入力／印字されていること。出願書類の文面および線は判読可能で、修正箇所がなく、文書の内容が整然としていて確認できるものであること。これらの要件が満たされて初めて、意匠出願は受理される。

■ 出願当初の意匠の開示の範囲を超えるものは拒絶または出願却下となることから、出願日の認定は、形式的な要件だけではなく意匠の特定が要件となる、との解釈でよいでしょうか。

Answer:

As long as the determination of the filing date meets the above-mentioned formality requirements, the design application can be accepted, a formal official Filing Receipt will be issued and the filing date will be fixed.

回答：

出願日の判断において、上記の形式的な要件が満たされておりさえすれば、意匠出願は受理され、正式な出願受領証が交付され、出願日が確定される。

Question 4-8 In the case specified in Question 4-7, after an applicant makes an amendment in response to an order for amendment that the IP Office issued on the grounds that the requirements for according the application filing date were not satisfied, if said requirements are satisfied as a result of the amendment, which date does the IP Office accord as the application filing date, either the first application filing date or the date on which the amendment was submitted?

Answer Section 4-8 (Provided by Linda LIU & Partners)

After an applicant makes an amendment in response to an order for amendment that the IP Office issued on the grounds that the requirements for according the application filing date were not satisfied, even if said requirements are satisfied as a result of the amendment, the first application filing date is still the application filing date.

出願日認定の要件を満たしていないとして知的財産担当官庁から補正指令が出されて、出願人が補正応答した結果、出願日の認定の要件を満たした場合でも、最初に出願した日が出願日になる。

→■ということは、当初に認定要件である項目を満たしていないときでも、最初に出願した日が出願日ということでしょうか。図面がない場合でも最初の出願日になるとは考えにくいのですが。

Answer:

Please refer to the answer to Question 4-7.

回答：

Q4-7 の回答を参照。

■Q4-7 の解釈と異なりますが、(補正却下の考えがないことから) 要旨変更であっても拒絶または出願却下にならないケースが多いということでしょうか。それとも、この回答については、形式的要件についてのみの回答ということでしょうか。

Answer:

In China, if the requirements for acceptance are not met, the applicant won't have any chance to make an amendment but can only re-submit the design application documents that meet the requirements for acceptance, and the date of re-submission will be deemed as the filing date.

In the previous reply, our understanding of this question is not inaccurate. Please forgive us.

Please be noted that the filing date and the application number can be given once the requirements for acceptance are met. The subsequent amendments to the drawings or

photographs and the brief explanation will not generate the necessity to re-determine the filing date. That is to say, for a design application, the date of amendment will not be deemed as a new date of filing.

回答：

中国では、認定要件が満たされない場合、出願人には補正を行う機会はなく、認定要件を満たす意匠出願書類を再提出することしかできず、その再提出日が出願日と見なされる。

前回の回答の際は、この質問に対する当方の理解が正確でなかったことをお詫びしたい。

出願日と出願番号は、認定要件が満たされた時点で付与することができる。その後の図面や写真および簡潔な説明に対する補正では、出願日を再決定する必要性は生じない。すなわち、意匠出願においては、補正日は新たな出願日とは見なされない。

Question 4-9 In the case of an IP Office that conducts to find a design as a prerequisite for according the application filing date, please answer this question. In the case of any other IP Office, please skip this question and answer Question 5.

In the case mentioned in Question 4-8, if an amendment submitted to the IP Office changes the gist of the design, how would the amendment be treated? Would it be dismissed? Or, would it be deemed as a new application filed on the date on which the written answer to the order for amendment is submitted? Please explain in detail.

Answer Section 4-9

Question 5 Principle of unity

Question 5- 1 Please tell us the requirements for representations of designs in order for multiple designs to be regarded as a single design.

Please give us a detailed answer. For example, is it the case that the designs of articles that are used in a physically separated manner may be regarded as a single design as long as those designs are regarded as a set in terms of design (e.g., a set of stackable pans), that a set of similar designs may be regarded as a single design as long as those designs are similar to each other in terms of configuration¹, that the designs represented in a drawing in a physically separated manner may be regarded as a single design as long as those articles

¹ “Configuration” means here that the shape, patterns or colors, or any combination thereof, of an article. The same shall apply hereinafter.

are used simultaneously (e.g., a pen and its cap), or that the designs of different articles may be regarded as a single design as long as they are used simultaneously (e.g., a stationary article and its base)? Which requirements, either formality requirements (formality examination) or substantive requirements (substantive examination), must be met in order to recognize multiple designs as a single design? If multiple designs are not regarded as a single design, how would the IP Office treat them?

(Example) In Japan, a design application would be dismissed (i) if the applicant states two or more classifications of articles in the section entitled "Article which constitutes the design" of an application, (ii) if the applicant presents drawings of two or more articles, or (3) in the case of an application for the design of a part of an article, if the application covers two or more physically separated parts. If an application is dismissed for any of the aforementioned reasons, the applicant may file a divisional application (substantive requirements).

Answer Section 5-1 (Provided by Linda LIU & Partners)

In China, two or more similar designs for the same product or two or more designs which are incorporated in products belonging to the same class and sold or used in sets may be filed as one application According to Article 31 of the Patent Law of China,.

専利法第 31 条によれば、中国では、同一製品における 2 以上の類似意匠、あるいは同一種類でかつセットで販売または使用される製品の 2 以上の意匠は、1 件の出願として提出することができる。

“products belonging to the same class and sold or used in sets” means “are customarily sold or used at the same time and the design of which have the same concept”.

「同一種類でかつセットで販売または使用される」とは、一般的に同時に販売または使用され、その意匠の概念が同じであることを意味する。

If the submitted designs satisfy the above requirements (Substantive requirements), it is permitted to be filed as one application. if not satisfy the above requirements, the examiner may ask the applicant to file a divisional application or delete the other designs.

提出された意匠が上記の要件（実体要件）を満たせば、1 件の出願として提出することが認められ、要件を満たさない場合、審査官が出願人に対して分割出願を提出するか、他の意匠を削除するよう求めることができる。

→■具体的に、以下の場合に一の意匠と認められるか、○×で教えて下さい。

例 1) 鍋とふた ×

例 2) ナイフとスプーン ○

例 3) テレビとテレビ台 ×

■ 中国では類似する意匠は 10 意匠まで一括で出願できるが、分割されることで 11 以上の意匠になってしまう場合はどのような扱いとなりますか。願書を別途に作成提出するということでしょうか。この場合の出願日は、原出願の日でしょうか、新たな出願日でしょうか。

Answer:

With regard to this question, we guess that you wish to know how the examiner will deal with a design application incorporating more than ten designs, and our answer is as below:

An application for similar designs may include ten designs. Once the number of designs in

the application exceeds ten, the examiner will issue an Office Action to require the applicant to delete some designs so as to control the total number of designs below ten; for the deleted designs, the applicant can file a divisional application that enjoys the original filing date.

回答：

この質問は、出願に含まれる意匠が 10 より多い場合に、審査官がその出願をどのように扱うかという趣旨であると推察して回答する。

類似する意匠の出願は、10 意匠まで可能であり、10 を超えた場合は、審査官がオフィスアクションを発し、出願人に対して、いくつかの意匠を削除して、意匠の合計が 10 以下に抑えられるように求める。削除されて意匠については、原出願の出願日で分割出願できる。

Question 5-2 This is a question to the IP Office of any country that protects images. If your country does not protect images, please skip this question and answer Question 6.

Please tell us the provisions concerning representations of drawings that are required to be made in order to have multiple images regarded as a single design. Which requirements, either formality requirements (formality examination) or substantive requirements (substantive examination), must be met in order to have multiple images regarded as a single design? If multiple images are not regarded as a single design, how would the IP Office treat them?

(Example) In Japan, multiple images may be regarded as a single design covering multiple images in the case where the image before a change and the image after the change are used in relation to the same function of an article as long as those two images are considered to be related to each other in terms of configuration. If multiple images are not regarded as a single design, the application would be dismissed on the grounds that multiple images should be regarded as multiple designs (substantive requirements).

Answer Section 5-2

Question 6 Scope of design protection

Question 6-1 Based on what definitions or ideas concerning the similarity of the configurations of designs do you determine the scope of design protection? Please give us any judicial precedent where the court presented its interpretation about how to interpret the scope of design protection from the perspective of configuration similarity, for example, whether the scope of design protection only covers almost identical designs or covers designs of different degrees of similarity (variations).

Answer Section 6-1 (Provided by Linda LIU & Partners)

There is no specific definition or ideas concerning the similarity of the configurations of designs. The determination should be made according to the knowledge and cognitive capability of a normal consumer, and the comparison of designs shall be made through the approach of whole observation and comprehensive judgment rather than through observing parts or details of the designs.

意匠の形態類似に関する定義・概念はない。類似の判断は、一般的な消費者の知識および認識能力に基づいて行うべきであり、意匠の比較においては、部分や詳細ではなく、意匠全体を観察して、総合的な判断を行うべきである。

When making the determination, you should first determine whether the categories of the products are identical or similar. If they are identical or similar, you may then make a comparison between the two designs incorporated in the products. If they are not identical or similar, there is no need to make a comparison. If the categories of the products are identical or similar but the two designs incorporated in the products are different, you need to further analyze whether the difference(s) makes(make) a notable impact on the overall visual effect of the designs. If there is a notable impact, the two designs do not constitute similar designs. If no notable impact is made (e.g. the difference only lies in slight variations in some parts), the two designs will constitute similar designs.

判断の際はまず、製品の分類が同一または類似しているかどうかを判断すべきである。同一または類似している場合は、それらの製品の2つの意匠の比較を行う。同一でないか類似していない場合は、比較を行う必要はない。製品の分類が同一または類似していても、それらの製品の2つの意匠が異なる場合は、その相違が、意匠の全体的な視覚的影響に顕著な影響を及ぼすかどうか、さらなる分析をする必要がある。顕著な影響があれば、2つの意匠は類似した意匠ではない。顕著な影響がなければ（例：相違が、一部におけるわずかな変化のみの場合）、2つの意匠は類似した意匠である。

Interpretation of the Supreme People's Court on Several Issues concerning the Application of Law in the Trial of Patent Infringement Dispute Cases has the following provisions.

「特許侵害紛争裁判における法律適用に関するいくつかの問題に対する最高人民法院の解釈」には以下のような規定がある。

Article 8: Where a design identical or similar to the patented design is used on the identical or similar categories of product, the People's Court should hold that the allegedly infringing design falls into “the scope of protection afforded by a design patent” prescribed in Article 59.2 of the Chinese Patent Law.

第8条：特許付与された意匠と同一または類似の意匠が、分類が同一または類似の製品に使用されている場合、人民法院は、被疑侵害意匠が、専利法第59.2条に定める「意匠特許による保

護の範囲」に入ると見なすものとする。

Article 11: Whether designs are the same or similar by comprehensively considering design features of the patented design and the allegedly infringing design as well as the overall visual effect of the designs. However, the design features mainly determined by the technical effect of the product and those features that cannot affect the overall visual effect, such as the material and internal structures, shall not be taken into consideration.

第11条：意匠が同一または類似のものかどうかは、特許付与された意匠および被疑侵害意匠の特徴、さらには両者の全体的な視覚効果を総合的に判断する。ただし、主として製品の技術的效果によって決まる意匠の特徴や、全体的な視覚効果に影響を与えない特徴、例えば、材質や内部の構造などは、考慮に入れないものとする。

The following exerts greater influence to the overall visual effect:

1. The parts of products which are easy to be observed directly in normal use;
2. The design features which distinguish the patented design from the existing designs.

次のものは、全体的な視覚効果に大きな影響を与える。

1. 製品の通常の使用において、容易に直接観察できる部分
2. 特許付与された意匠を既存の意匠と区別する特徴

Where there is no difference in the overall visual effect between the allegedly infringing design and the patented design, the People's Court should recognize them as the same. If there is no substantial difference in the overall visual effect between the allegedly infringing design and the patented design, the People's Court should recognize them as similar.

被疑侵害意匠と特許付与された意匠との間で、全体的な視覚効果に差がない場合、人民法院は、両者が同一であると認めるべきである。また、被疑侵害意匠と特許付与された意匠との間で、全体的な視覚効果に大きな差がない場合、人民法院は、両者が類似していると認めるべきである。

Question 6-2 Please explain in detail how the scope of design protection is affected by the identity or similarity of articles or by the identity or similarity of the functions and use of articles. Please give us any judicial precedent where the court presented its interpretation as to how the scope of design protection is affected by these factors.

Answer Section 6-2 (Provided by Linda LIU & Partners)

No matter you are at the right-confirmation stage or the right-exercising stage, you should first determine whether the categories of articles are identical or similar, and then you may make a comparison between the designs of the articles.

権利確認の段階か、あるいは権利行使の段階かに関係なく、まず物品の分類の同一／類似を判断することで、それらの物品の意匠を比較することができる。

Products of similar categories refer to products that have similar use. For example, a toy and a tiny ornament are products of similar categories, because they have similar use. It should be noted that for products having multiple uses, if some of the uses are the same and some are not, they are regarded as products of similar categories.

分類が類似している製品とは、用途が類似した製品のことである。例えば、おもちゃと小型の装飾品は用途が似ているため、分類が類似した製品である。ただし、複数の用途がある製品どうしで、同じ用途とそうでないものがある場合、これらの製品は分類が類似していると見なす。

It is provided by Article 9 of the *Interpretation of the Supreme People's Court on Several Issues concerning the Application of Law in the Trial of Patent Infringement Dispute Cases* that the People's Court should determine whether products are within the similar or same category by considering their uses. To determine the use of a product can refer to the brief description, International Classification of Designs, the function of the product and other factors such as sale and actual use of the product.

「特許侵害紛争裁判における法律適用に関するいくつかの問題に対する最高人民法院の解釈」の第9条では、人民法院は、製品分類の同一／類似について、その用途を考えて判断すべきと規定している。製品の用途を判断する際は、国際意匠分類の要約記述書、製品の機能、また製品の販売や実際の用途など、その他の要因も参照することができる。

The comparison is conducted only when the products are within the similar or same category. If the products are not within the same category, the right cannot be exercised even if the designs are completely identical.

比較は、製品の分類が同一／類似の場合にのみ行う。製品の分類が同一でない場合は、仮に意匠がまったく同一であったとしても、権利は行使できない。

■ アンケート回答によれば、分類は官庁が付与するとのことですが、官庁内の誰が、どのような基準に従って付与していますでしょうか。分類付与基準はありますか。

Answer:

The classification is done by the Classification Division in the Design Department of the SIPO, by referring to the Locarno Classification and the Examination Guide used inside the SIPO.

回答：

分類は、SIPO 意匠部門の分類課が、ロカルノ分類と SIPO 内部で使用している審査ガイドラインを基準にして行っている。

■ アンケート回答によれば、同一となる分類内の物品はすべて類似物品となるとのことですが、分類が権利範囲に大きく影響することから、付与された分類に対し、出願人から意見や修正依頼が出されたり、その機会を設けたりすることはありますか。

Answer:

When issuing a Notification to Grant Patent Right and Make Registration, the examiner will add the classification information to the notification; if the applicant has a different view over the classification, the applicant can communicate with the examiner or make observations.

回答：

特許権付与・登録の通知を交付する際、審査官は、その通知に分類情報を添える。出願人が、分類に関して異なる見解を持っている場合は、審査官と連絡を取るか、意見を提出することができる。

Question 6-3 Please explain in detail how the scope of design protection is affected by the parts of an article that are not represented in drawings or photographs.

Answer Section 6-3 (Provided by examiner in Design Department of SIPO)

Where a view of the product incorporating the design is omitted, the applicant shall generally indicate the reason of the omission of the view, such as a view is omitted because it is symmetrical or identical with another view; if it is hard to indicate the reason, may only indicate the view which is omitted, for example, a large-scale apparatus lacks bottom view, it may be describe as “bottom view is omitted”. We may consider the parts of an article that are not represented in drawings or photographs as usual design.

意匠を含む製品の図を省く場合、通常は、対称図形のため省いた、あるいは別の図と同一のため省いたというように、省略の理由を示す必要があるが、理由を示すのが困難な場合は、省いた事実のみを示すこともでき、例えば、大型装置の底面図がない場合、「底面図は

省略」のように示す。図面や写真で表されない物品の部分も、通常の意匠と見なすことができる。

→質問の趣旨ご理解いただけなかったかと思われます。一般的に、図面等に表れていない箇所についての効力範囲には何らかの制限があるものと考えられていますでしょうか。説明のない、省略した図の部分は類否判断に影響を与えないのでしょうか。それとも、類否判断上、通常考えられる状態の図を想定して判断に入ると考えて良いのでしょうか。

Answer:

The extent of protection of the patent right for design shall be determined by the design of the product as shown in the drawings or photographs. During the determination of similar designs, the omitted view will be taken into account by assuming it as a side in a general, common state or by assuming it as a side incorporating no design. However, whether the omitted view will affect the determination of similar designs has to be determined based on the actual situation. In addition, China does not protect partial designs; during the determination of similar designs, the principle of “whole observation and comprehensive judgment” is adopted, and not just a part of the design is focused on.

回答：

意匠特許権の保護範囲は、図面または写真に示された製品の意匠によって判断される。類否判断においては、省略された図は、通常考えられる状態の面を想定して、あるいは意匠を含まない面を想定して考慮に入れられる。ただし、省略された図が、類否判断に影響するかどうかは、実際の状況に基づいて判断される。また、中国では、部分意匠は保護されない。類否判断においては、「全体観察と総合的判断」が採用され、意匠の一部のみに焦点を当てることはない。

Question 6-4 In the case of a design right for an article which partially changes to perform its functions, does the scope for design protection cover the configurations observed in the course of change? Or, does the scope of design protection cover only the configuration before a change and the configuration after the change?

The following is a specific example where a part of an article (toy) that has a three-dimensional configuration changes its configuration to perform its functions.

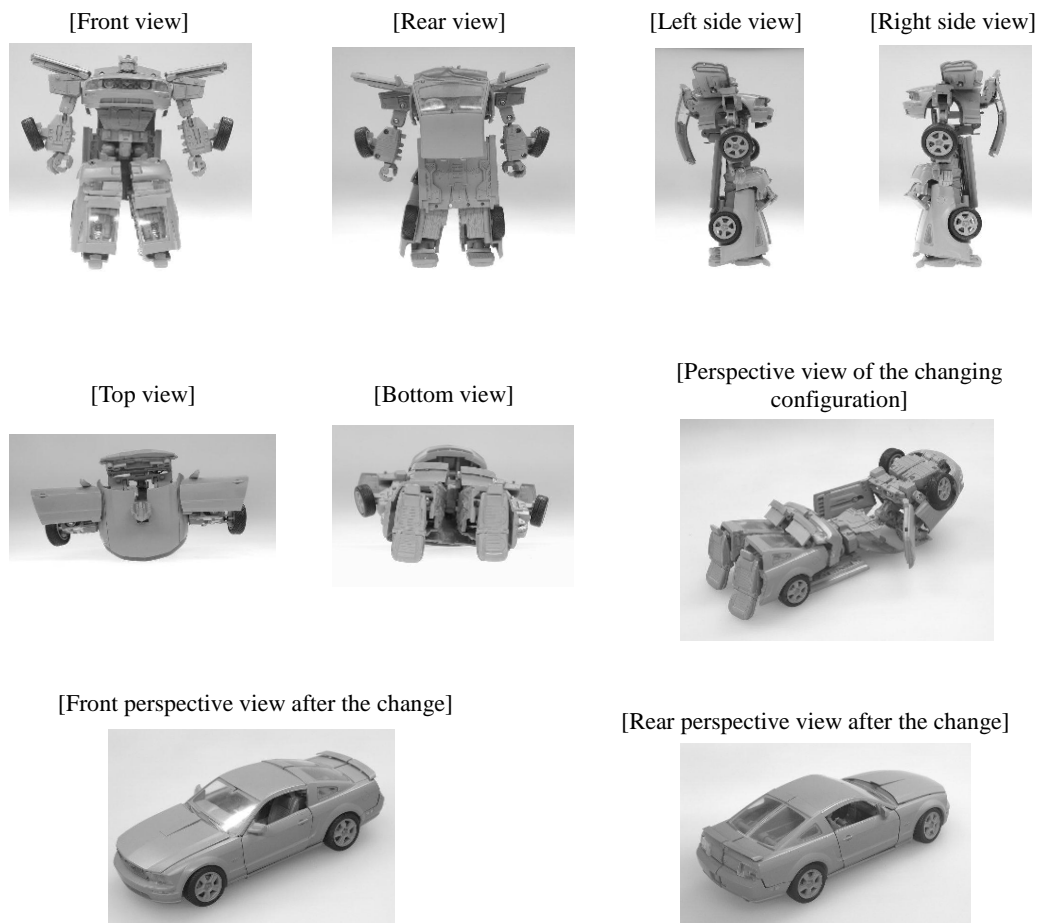

Answer Section 6-4 (Provided by examiner in Design Department of SIPO)

The scope for design protection covers the configurations observed in the course of change.
 変化の過程における形態にも権利が及ぶ。

Question 6-5 This question is about the scope of design protection in the case of a set of articles or a certain set of articles. Does the design protection only cover a set of articles or a certain set articles? Or, does the design protection also cover each article that comprises a set?

If simultaneously used multiple articles are coordinated as a whole, the designs of those articles may be regarded as a single design. Such a design may be regarded as a "design for a set of articles." The term "a design for a certain set of articles" is conceptually the same as "a design for a set of articles." The term "a design for a certain set of articles" refers to a design used for any of the prescribed types of set.

Answer Section 6-5 (Provided by examiner in Design Department of SIPO)

The design protection only covers a certain set articles which are the same as products in set (Article 31 of the Patent Law of China). Products in set means that two or more products belonging to the same class, but independent from each other. The design concepts for the products are the same. Each product has its own independent value of use.

As each product has its own independent value of use, the design protection covers each article that comprises a set.

意匠保護は、同一の製品としてセットになっている物品のみに及ぶ（専利法第 31 条）。セットの製品とは、種類は同じだが、互いに独立している 2 つ以上の製品をいう。意匠の概念は同じだが、それぞれに独立した使用価値のある製品をいう。

製品ごとに独自の使用価値があるので、意匠保護は、セットを構成する各物品に及ぶ。

→■セットになっている物品のみに及ぶのは日本と同じですが、後段のセットを構成する各物品に及ぶ旨の回答は矛盾しているように思われます。実態を教えてくださいませんか。

Answer:

We do not understand the contradiction mentioned by you. The products in set as prescribed by Article 31 of the Chinese Patent Law, that is, “two or more designs which are incorporated in products belonging to the same class and sold or used in sets”, can be included in one application. For example, the four-piece sheet set and the combination sofa can be applied for as products in set. For the products in set, each design can separately enforce its right. China also prescribes a “combination product” such as toy bricks and poker; although the view of each component is filed when filing the applicant for a combination product, each component cannot separately enforce its right.

We only know a little about the Design Act in Japan. In our opinion, the “design for a set of articles” and “a design for a certain set of articles” in Japan are probably different from the concepts “products in set” and “a combination product” in China, so we only inform you of the provision about “products in set” and “combination product” in China. We also wish to thoroughly understand this matter, and please give your explanation if it is convenient for you.

矛盾と言われる意味が理解できない。専利法第 31 条に規定されているようなセットの製品、つまり「同一種類で、かつセットで販売又は使用する製品の 2 つ以上の意匠」は、1 件の出願にすることができる。例えば、4 枚組のシーツのセットとソファの組合せは、セットの製品として出願できる。セットの製品については、意匠ごとに個別に権利を行使できる。また中国では、ブロック玩具とポーカーのような「複合製品 (combination)」も規定されている。複合製品は、出願時に構成要素ごとの図を提出するが、構成要素ごとに個別に権利を行使することはできない。

日本の意匠法についてはよくわからないが、日本の「組物」や「セットもの」は、おそらく中国の「セット製品」や「複合製品」の概念とは異なると思われるため、とりあえず

中国の「セット製品」および「複合製品」の規定について紹介した。当方としても、この問題については十分に理解したいので、よろしければ説明いただきたい。

Question 6-6 This is a question about the restrictions on the exercise of design rights that are related to each other in conflict of which both right holders and both filing dates are deferent.

Design rights are considered to be related to each other in conflict in the following three cases:

- (i) a design right to protect the design of a whole article and a design right to protect the design of a component of the article (the component can be regarded as an independent article). Filing date of the design right of a component of the article is earlier than filing date of the design right of a whole article. Both rights are owned by deferent persons;
- (ii) a design right to protect the design of a whole article and a design right to protect the design of a part of the article (a part means a portion of the article and cannot be separated as a component). Filing date of the design right of a part of the article is earlier than filing date of the design right of a whole article. Both rights are owned by deferent persons; and
- (iii) a design right to protect the design of a set of articles or a certain set of articles and a design right to protect the design of any article that comprises a set. Filing date of the design right of any article that comprises a set is earlier than filing date of the design right of a set of articles or a certain set of articles. Both rights are owned by deferent persons.

For example, in Case (i) above, if the holder of a design right to protect the design of a whole article works the design or exercises the design right, is it sometimes necessary for him/her to obtain a license from the holder of a design right to protect the design of a component? How about the situations in Case (ii) and Case (iii) described above in terms of the restrictions on the exercise of design rights?

Answer Section 6-6 (Provided by examiner in Design Department of SIPO)

In Case (i), it is sometimes necessary.

In Case (ii), it is not necessary.

In Case (iii), it is sometimes necessary.

(i)では、必要な場合がある。

(ii)では、必要なし。

(iii)では、必要な場合がある。

Question 6-7 This is a question to the IP Office of any country that protects multiple images as a single design.

If your country does not protect multiple images as a single design, please skip this question and answer Question 7.

In the case of two related design rights, i.e., a design right to protect the designs of multiple images and a design right to protect the design of any of those images, are in conflict. Filing date of the design right of any of those images is earlier than filing date of the designs right of multiple images. Both rights are owned by deferent persons. In this case, are any restrictions imposed on the exercise of those design rights?

Answer Section 6-7

Question 6-8 This is a question to the IP Office of any country that protects multiple images as a single design and conducts substantive examination. If your country does not protect multiple images as a single design and does not conducts substantive examination, please skip this question and answer Question 7.

In case of a application seeking for a protection of a design of multiple images When filing date of a application seeking for a protection of design of any those images is earlier than filing date of a application seeking for a protection of a design of multiple images, and both applicants are different, what measures do you take when determining whether such a design has novelty and is not easily creatable by any person skilled in the art?

Answer Section 6-8

Question 7 Disclosure by drawings included in application documents and publication by gazettes

Question 7-1 Are there any cases where a drawing or photograph included in application documents is edited (e.g., altered in size or ratio) when the design is publicized in a design gazette (including an electronic gazette)? If editing is conducted, please tell us the reasons and standards for editing.

Answer Section 7-1 (Provided by examiner in Design Department of SIPO)

Yes, there are. If the scale of various views is not the same, and it is caused by the scanning entry problem, then the editing is conducted, but only the ratio can be edited, not the content of the design.

ある。さまざまな図の尺度が同じでない場合、それがスキャナーからの取り込みが原因である場合は編集を行うが、編集できるのは比率のみであって、意匠の内容を編集することはできない。

Question 7-2 If a design application is filed by an electronic medium, do you store printed-out hardcopies of the representations of the design as the original documents in addition to the submitted electronic images of those representations? If yes, why?

Answer Section 7-2 (Provided by examiner in Design Department of SIPO)

No, we don't.

保管していない。

Question 7-3 Does the public have access to the documents (including electronic data) prepared in the course of design prosecution starting from the filing of a design application to the registration of the design? If yes, please tell us the inspection fee and conditions (to what extent is inspection permitted? Are there any documents that are not available for inspection?).

Answer Section 7-3 (Provided by examiner in Design Department of SIPO)

Any person may file a request with the Patent Office to consult or photocopy the file of the patent application for granted design. The inspection is for free. Until the announcement of the grant of patent right for design, the requester for consultation or photocopying is limited only to the applicant and agent thereof.

誰でも、登録された意匠の出願ファイルの参照または写しを、特許庁に対して請求できる。閲覧は無料である。意匠の特許権付与が発表されるまでは、参照または写しの請求者は、出願人およびその代理人に限定される。

→■「出願ファイル」とは、出願から登録までの出願人と官庁とのやりとりすべてが含まれていますか。また、閲覧可能な場所は特許庁のみでしょうか。

Answer:

Your opinion is correct. The “application file (file wrapper)” includes all the documents

that the applicant submits to and receives from the SIPO from the filing of the application to the allowance of the application.

The public can file a paper request for file wrapper of a design patent with the Consulting Center of SIPO; or they can visit the website of the China Patent Inquiry System (http://cpquery.sipo.gov.cn/index_en.jsp?language=en_US) to check the information regarding the design patent.

回答：

その理解でよい。出願ファイル（包袋）には、出願書類の提出から許可までの間に、出願人と SIPO との間でやりとりされたすべての書類が含まれている。

意匠特許の包袋を閲覧するには、SIPO の Consulting Center に対して、紙ベースで請求するか、中国特許照会システムのサイト

(http://cpquery.sipo.gov.cn/index_en.jsp?language=en_US) で、意匠特許に関する情報を確認することもできる。

Question 8 Do you receive any opinions from users of the design system such as a request for a revision of the design system in order to change the way of representing a design in a design application under the relevant laws, regulations, and examination guidelines of your country and to remedy the current situation where the way of representing a design differs from one country to another? If yes, please describe those opinions in detail.

Answer Section 8 (Provided by examiner in Design Department of SIPO)

Yes, we do.

We receive opinions such as submitting the drawings of a design application in 3DSMax format, so that the examiner can observe the product in all directions.

出されている。

審査官が製品をあらゆる方向から観察できるようにするため、意匠出願の図面を 3DSMax フォーマットで提出できるようにすべき、といった意見が寄せられている。

→■自国の規定が厳しいとの意見はありませんか。意見がある場合、具体的にどのような点が厳しいと言われていましたか。

Answer:

China and Japan basically have the same requirements on the views, except that the broken lines cannot be used in China. We have not thoroughly studied the requirements of other countries on the views, so we temporarily cannot judge which country has stricter requirements.

回答：

中国では破線を使用できないことを除けば、中国と日本の図に関する要件は基本的には同じである。図に関する他国の要件について詳しく調査したことはないので、どの国がより厳しいかについては、この場では判断できない。

Question 9 In recent years, has the number of design applications been on the rise or on the decline?
What do you think has caused such increase or decrease?

Answer Section 9 (Provided by examiner in Design Department of SIPO)

The number of design applications has been on the rise.

I think the main reason is because of the outline of the national intellectual property strategy's announcement and the improvement of China's capacity to create.

意匠出願件数は増加傾向にある。

主な要因としては、国の知的財産戦略の概要が公表されたこと、中国の創作能力が向上したことなどがあると考えている。

Question 10 If your country has signed the Hague agreement, please answer this question. Did the number of design applications increase or decrease in your country before and after the signing of the Hague agreement?

Answer Section 10

Question 11 If your country has signed the Hague agreement, please skip this question and answer Question 12.

This is a question to the IP Office of any country that is planning to sign the Hague agreement. What are your purposes for signing the Hague agreement? Please describe your purposes in detail.

Answer Section 11 (Provided by examiner in Design Department of SIPO)

Hague agreement is an effective way to protect the design right for Chinese enterprises, especially for those companies who want to compete with other countries.

ヘーグ協定は、中国企業、とりわけ他国との競争を望んでいる企業にとって、意匠権を保護する効果的な手段である。

Question 12 Please answer this question if your country has signed the Hague agreement or is planning to do so. In order to sign the Hague agreement, did you have to make any alterations or adjustments to your country's system? Or, is your country planning to alter or adjust your country's system in the future?

Answer Section 12 (Provided by examiner in Design Department of SIPO)

Yes, we are planning to make some alterations or adjustments to our country's system in the future.

今後、わが国の制度を変更・調整する予定である。

[Request for information]

13 If your country has adopted a multiple design application system, please send us information on how an application and drawings should be prepared in order to file a multiple design application. We would appreciate if you could send us a sample application and a sample drawing that are available for disclosure (those with all the sections filled in with information as a sample). If such application and drawing are not available for disclosure, please send us a blank application form, etc., if possible.

Answer Section 13 (Provided by examiner in Design Department of SIPO)

In china, only two or more similar designs for the same product or two or more designs which are incorporated in products belonging to the same class and sold or used in sets may be filed as one application According to Article 31 of the Patent Law of China. We supply a blank sample application for your reference, the applicant just needs to add the numbers of designs on the portion indicated by red frame compared with the single application.

中国では、同一の製品における 2 以上の類似意匠、あるいは同一種類でかつセットとして販売または使用される製品の 2 以上の意匠のみを、専利法第 31 条に基づき、一件の出願として提出できる。ご参考のため、見本（空欄のもの）を添付する。単一の出願との違いは、赤枠で囲った部分に、意匠の数を記入することのみである。

14 Is it possible for you to send us a sample registration certificate? Again, we would appreciate if you could send us such a certificate with all the sections filled in with information as a sample. If such certificate is not available for disclosure, please send us a blank certificate form, if possible.

Answer Section 14 (Provided by examiner in Design Department of SIPO)

Yes, we just send you a blank registration certificate, please see the following page.
登録証（空欄のもの）をお送りする。次ページを参照。

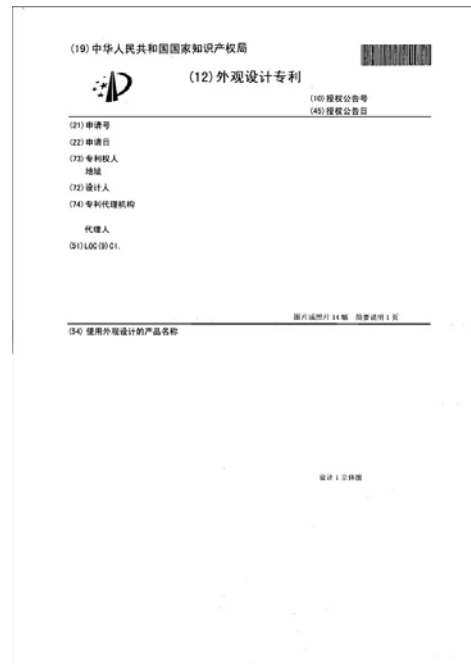

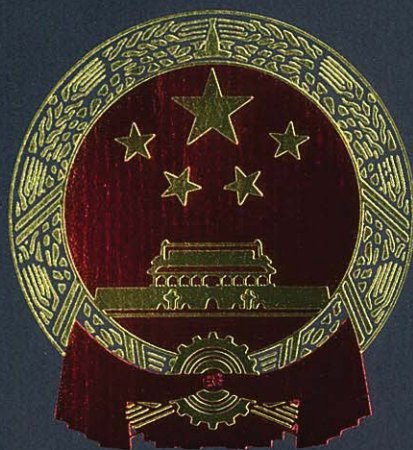

外观设计专利证书

Certificate of Design Patent

中华人民共和国国家知识产权局

STATE INTELLECTUAL PROPERTY OFFICE OF THE PEOPLE'S REPUBLIC OF CHINA



证书号第 1845701 号



外观设计专利证书

外观设计名称：瓶子

设计人：吉井孝平

专利号：ZL 2011 3 0061482.9

专利申请日：2011 年 03 月 28 日

专利权人：麒麟饮料株式会社

授权公告日：2012 年 02 月 22 日

本外观设计经过本局依照中华人民共和国专利法进行初步审查，决定授予专利权，颁发本证书并在专利登记簿上予以登记。专利权自授权公告之日起生效。

本专利的专利权期限为十年，自申请日起算。专利权人应当依照专利法及其实施细则规定缴纳年费。本专利的年费应当在每年 03 月 28 日前缴纳。未按照规定缴纳年费的，专利权自应当缴纳年费期满之日起终止。

专利证书记载专利权登记时的法律状况。专利权的转移、质押、无效、终止、恢复和专利权人的姓名或名称、国籍、地址变更等事项记载在专利登记簿上。



局长

田力普





(12) 外观设计专利

(10) 授权公告号 CN 301844052 S

(45) 授权公告日 2012.02.22

(21) 申请号 201130061482.9

(22) 申请日 2011.03.28

(73) 专利权人 麒麟饮料株式会社

地址 日本东京都

(72) 设计人 吉井孝平

(74) 专利代理机构 中原信达知识产权代理有限

责任公司 11219

代理人 顾缨 车文

(51) LOC(9) CI.

09-01

图片或照片 10 幅 简要说明 1 页

(54) 使用外观设计的产品名称

瓶子

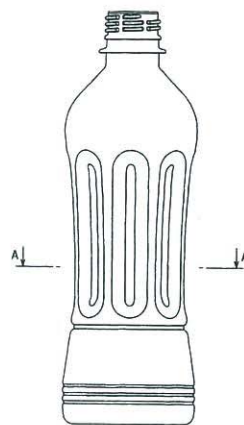

主视图

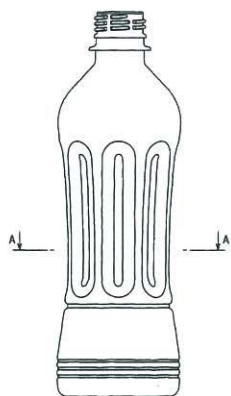

主视图

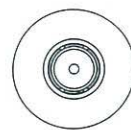

俯视图

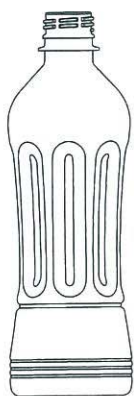

后视图

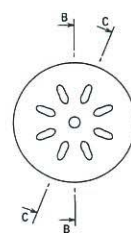

仰视图

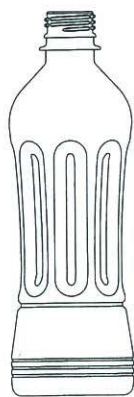

左视图

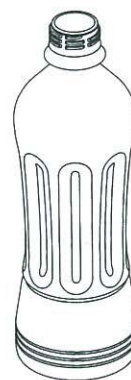

立体图

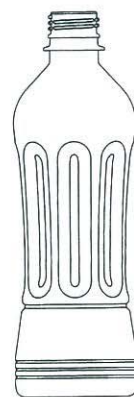

右视图



A-A 剖面图

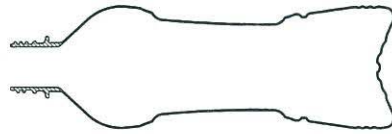

B-B 剖面图

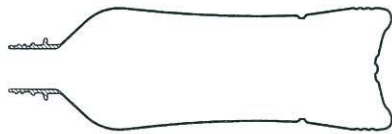

C-C 剖面图

1. 外观设计产品名称 :瓶子。
2. 外观设计产品用途 :一种包装用容器。
3. 设计要点 :如提交视图中所示的产品形状与图案的结合。
4. 最能表明设计要点的视图 :主视图。

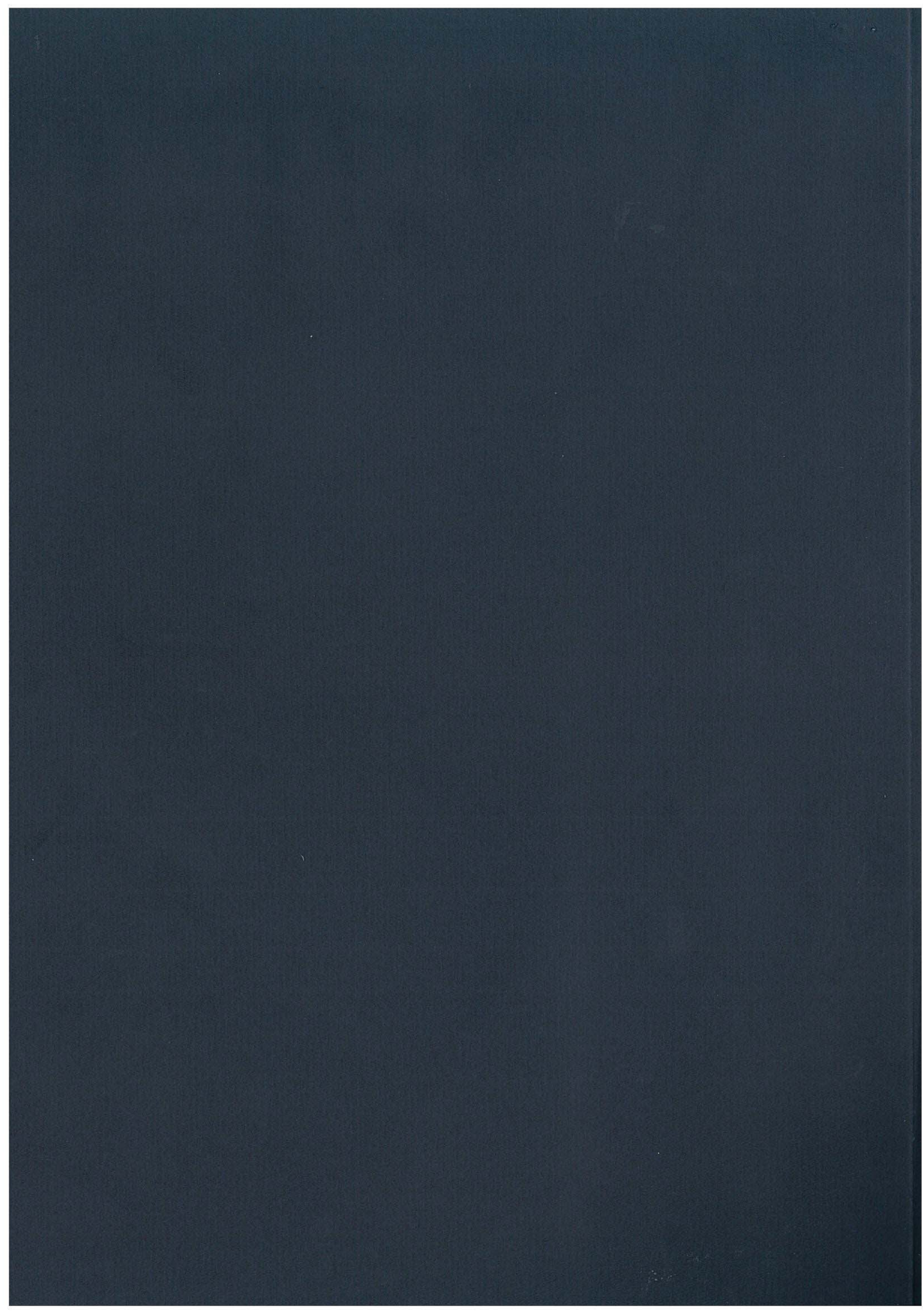

Request Form for Design

		For Official Use Only			
(6) Title of design			(1) Filing No. (Design)		
			(2) Filing Date of divisional application		
(7) Composer(s)			(3) Filing Date		
			(4)		
			(5)		
(8) Applicant(s)	Applicant (1)	Name (Representative)			
		Nationality or country of residence	TEL.		
		Address	Postal Code		
	Applicant (2)	Name (Representative)			
		Nationality or country of residence	TEL.		
		Postal Code	Address		
	Applicant (3)	Name (Representative)			
		Nationality or country of residence	TEL.		
		Postal Code	Address		
	(9)	Name		TEL.	
		Postal Code	Address		
(10)					
(11) Agent	Agency	Name		Code	
		Postal Code	Tel		
		Address			
	Attorney 1	Name		Attorney 2	Name
		Reg. Code			Reg. Code
		Tel			Tel
(12) Divisional appln.	Filing No., previous appln.	No. of Corresponding Divisional appl.	Filing date, previous appln.		

(13) Title of Design				(14) Class of goods	
(15) Priority Claim	Country of prev. appln.	Prev. filing date	Prev. filing No.	(16) Claim for no losing in Novelty	<input type="checkbox"/> 1st exhibited at an exhn.sponsored/ recognized by CN Govt. <input type="checkbox"/> 1st disclosed at a pre-scribed acad./tech. Meeting <input type="checkbox"/> discovered without permission of the applicant
(17) Check List				(18) List of document attached	
1.request	2	copies each	Pages	<input type="checkbox"/> Request for reduction of fees	copy each Page
2. Figures/ photos	2	copies each	Pages	<input type="checkbox"/> Certificate supporting request for reduction of fees	copy each Page
3. brief explanation	2	copies each	Page	<input type="checkbox"/> Assignment	copy each Page
				<input type="checkbox"/> Power of Attorney	copy each Page
				<input type="checkbox"/> Translation of the cover page of the priority document	copy each Page
				<input type="checkbox"/> Certified priority document	copy
				<input type="checkbox"/> Copy of original application text	copy each Page
				<input type="checkbox"/>	
number of figures / photos: pieces in total					
(19) Signature or chop by applicant or agency				(20) Result of the Chinese Patent Exam	
Date:				Date:	

Information Sheet in Foreign Languages

<p>Title Of Design</p>	
<p>Name of the Composer(s)</p>	
<p>Name and Address Of the Applicant(s)</p>	

Interview Survey on IP Offices Concerning Representations of Designs

Name of the Country: USA

Time and Date of Visit (or Telephone conference): Teleconference Nov. 12, 2012 + e-mail correspondence

Visited IP Office:

Name of the Person Representing the IP Office (Please write if possible): Joel Sincavage, SPE

Names of the Visitor and the Firm: John Bird, Sughrue Mion, PLLC

Question 1 Basic principle concerning representations of designs

Question 1-1 In the laws, regulations, examination guidelines, etc., of your country, there are provisions concerning the disclosure of designs. What is the underlying principle behind those provisions that determines the extent of disclosure of designs? In other words, when determining the extent of disclosure of designs, what are the primary goals of your country?

Example answers are listed below. Please give us a detailed answer.

- To facilitate formality examination or substantive examination.
- To facilitate storage of the submitted representations (drawings, photographs, specimens, etc.).
- To reduce the burdens on the users of the design system.
- To facilitate understanding of third parties (those other than design applicants and design holders)
- To facilitate the enforcement of rights.
- To ask for self-responsibility of the applicant who discloses his/her design.

Answer Section 1-1

The provisions that determine the extent of disclosure of a design is set forth in 35 USC 112(a) and (b). The appearance of the design applied to an article must be understandable and must be definite without resorting to conjecture.

The underlying principles or the primary goals behind those provisions are:

- 1. To convey clearly to those skilled in the art the information that the applicant has invented the specific subject matter claimed.**
- 2. To place the public on notice of the scope of the patentee's right to exclude.**

意匠の開示の範囲は、特許法第 112 条(a)および(b)で規定されている。物品に適用される意匠の外観は、推測に頼らなくても理解できる明確なものでなければならない。こうした規定の基本原則または主な目的は次の通りである。

1. クレームする特定の対象を出願人が発明したという情報を、当業者に明確に伝える。
2. 特許権者の排他権の範囲を、公衆へ通知する。

Question 1-2 In many cases, designers design industrial products by using 3D CAD and CG software. Does your country allow design applicants to use the 3D CG images created in the stage of product design such as those shown below as design representations to be included in design application documents?

[Article which constitutes the Design] Attachable wash-basin

[International Design Classification] 23-02

[Description of the Article which constitutes the Design] This design will be used mostly by medical staff to wash their hands in medical facilities, etc.

[Description of the Design] Each drawing was created using computer graphics software. The shading applied to the entire surface of the 3D configuration presented in each drawing shows the shape of the curved surface.

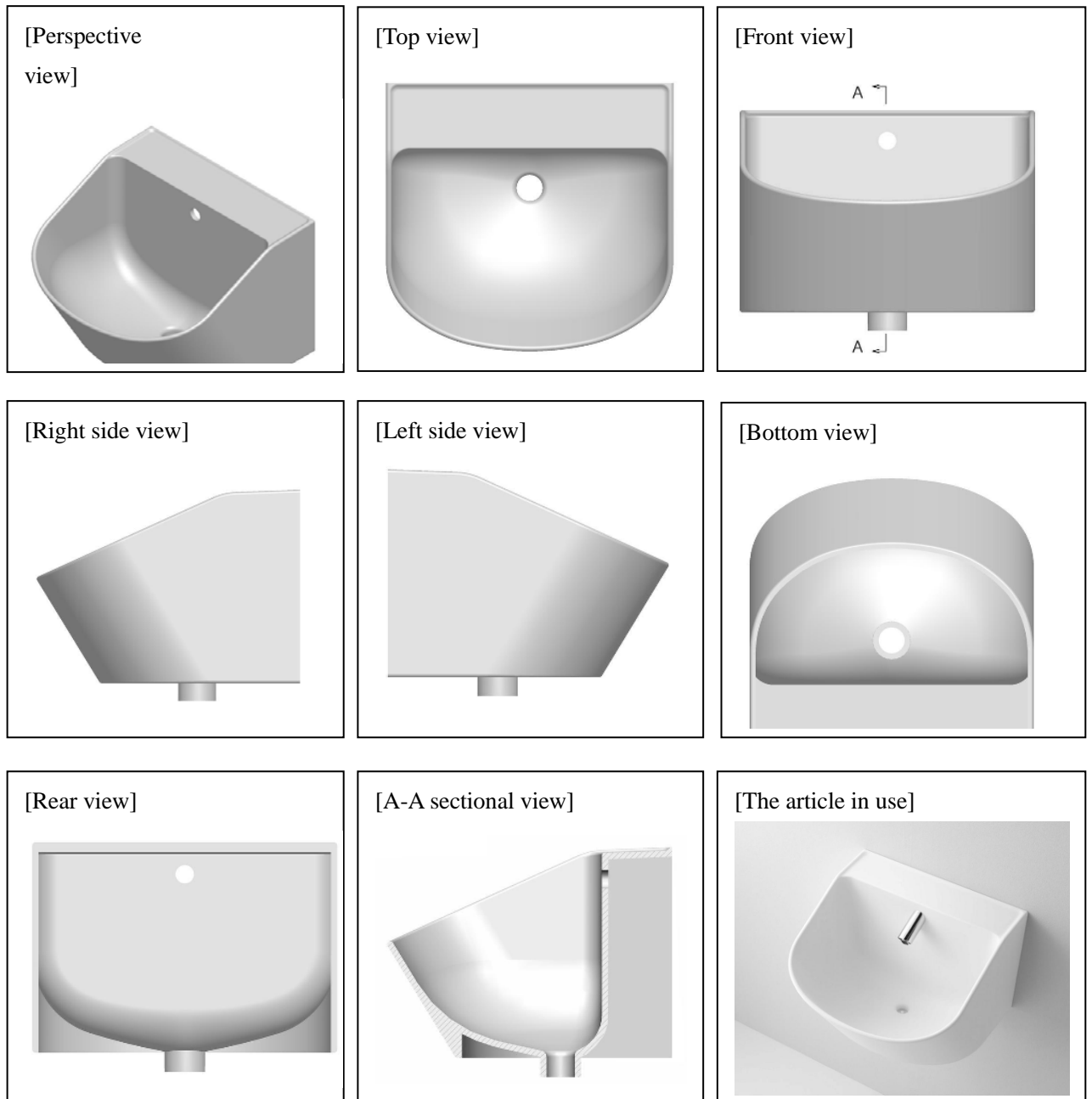

Japan Design Registration No. 1442550

Answer Section 1-2

Yes. As long as the drawings are sufficiently clear.

図面が十分に明瞭である限り、認められる。

Question 2 Representations of designs under the system to protect the design of a part of an article (partial design system)

Question 2-1 This is a question to the IP Office of any country that has either a partial design system or a system to protect the design of a part of an article. If you are representing the IP Office of any country that has neither of these systems, please skip this question and answer Question 2-2.

Two specific examples of representations of partial designs are given below. In the case of Example 1, an applicant seeking protection for a partial design used a different color to distinguish the partial design from the rest of the article. In the case of Example 2, an applicant seeking protection for a partial design used a different line (broken line) to distinguish the partial design from the rest of the article. Does your country allow such representations of partial designs? Please tell us whether and why each of the following two methods shown in the following examples is permitted or not?

(Example 1) A case where an applicant seeking protection for a partial design used a different color to distinguish the partial design from the rest of the article

[Article which constitutes the Design] Passenger car
 [International Design Classification] 12-08
 [Description of the Design] The applicant is seeking registration of the partial design of the part other than the pink part shown in the drawings. The bottom view is omitted because this is a heavy article. The shading applied to the entire surface of the 3D configuration presented in each drawing shows the shape of the curved surface.

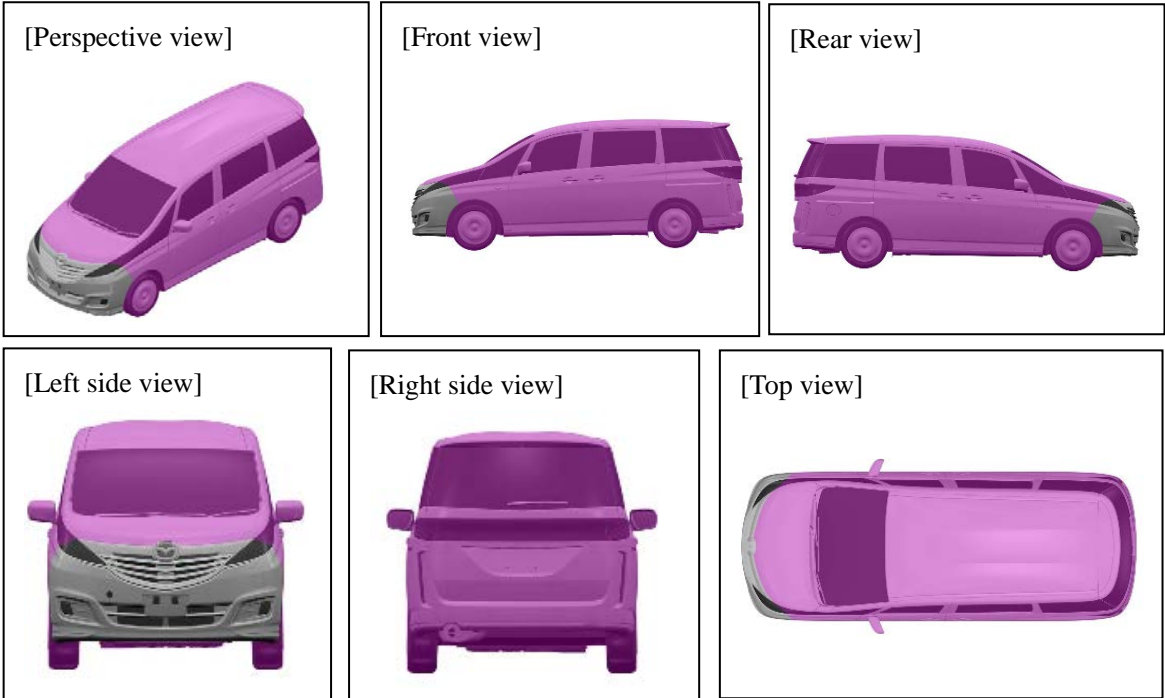

Japan Design Registration No. 1444223

(Example 2) A case where an applicant seeking protection for a partial design used a different line to distinguish the partial design from the rest of the article

[Article which constitutes the Design] Packaging container

[International Design Classification] 09-01, 09-02, 09-03, 09-04, 09-05, 28-01

[Description of the Design] The part drawn by a solid line shows the part for which the applicant is seeking registration as a partial design.

The rear view is symmetrical to the front view

The bottom view is the same as the top view.

The enlarged rear view of the cap is symmetrical to the enlarged front view.

The enlarged bottom view of the cap is symmetrical to the enlarged top view.

[Front view]



[Top view]



[Left side view]



[Right side view]



[Enlarged perspective view of the cap 1]

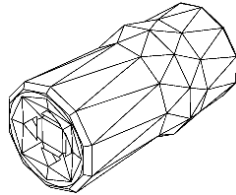

[Enlarged perspective view of the cap 2]

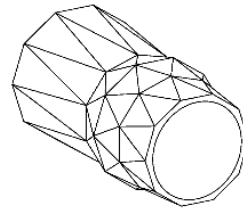

[Enlarged front view of the cap]

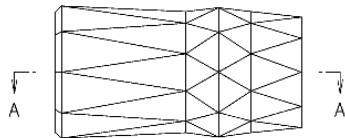

[Enlarged top view of the cap]

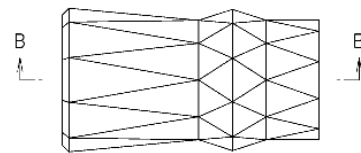

[Enlarged left side view of the cap]

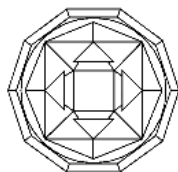

[Enlarged right side view of the cap]

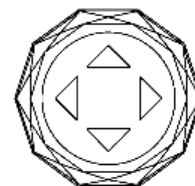

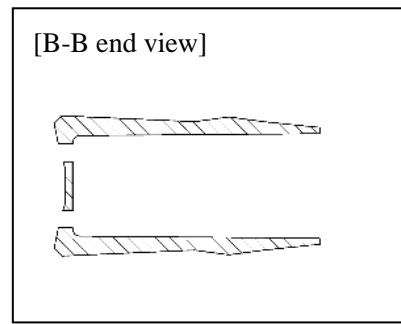
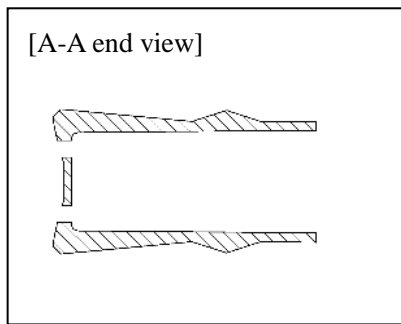

Japan Design Registration No. 1449069

Answer Section 2-1

In principle, each is acceptable for communicating the designer’s intention to the examiner. But the examiner would require both examples to be corrected before allowance.

それぞれ基本的には、意匠创作者の意図を審査官に伝える上で認められるが、どちらの例についても、許可の前に審査官が修正を求めると考えられる。

Since US patents are not published in color, in the black and white version of the images it is difficult to distinguish the portion of the car that represents the claimed design from the rest of the car. Applicant would have to choose another way to particularly point out what is claimed.

米国特許はカラーで公開されないため、白黒の画像では、自動車においてクレームする意匠の部分、それ以外の部分と区別するのは難しい。特に何をクレームするかを指し示すには、別の方法を選択する必要がある。



In the container example, lines A and B in the front view are light gray. The counterparts to A and B in the enlarged front view are black. We don’t know what the gray lines mean and the two views are inconsistent.

容器の例では、正面図の線 A と B は薄い灰色だが、拡大正面図では黒になっている。我々にはこの灰色の線の意味が理解できず、この2つの図は矛盾している。

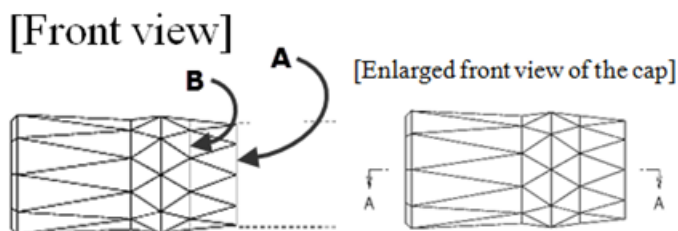

Question 2-2 This is a question to the IP Office of any country that has neither a partial design system nor a system to protect the design of a part of an article. If you are representing the IP Office of any country that has either of these systems, please skip this question and answer Question 3.

Do the users of the design system of your country request protection for the partial designs of articles? For example, is there a need for the establishment of a partial design system, which is an effective countermeasure against infringers of partial designs who copy only a unique and innovative part of an article without copying the design of the article as a whole?

Answer Section 2-2

Question 3 The policy of conducting to find designs

Please answer this question regardless of whether your country has adopted a system that conducts only formality examination before registration, a system that conducts both formality examination and substantive examination before registration, or a system that conducts formality examination on all applications and conducts substantive examination only on certain applications before registration.

Question 3-1 In the course of formality examination on the design claimed in an application, to what extent do you conduct to find the design? Example answers are listed below. Please give us a detailed answer.

- We examine whether an application satisfies the prescribed formality requirements such as the number, sizes, etc., of the submitted drawings or photographs but do not examine the design in further detail.
- In addition to whether a design satisfies the formality requirements, we conduct to find out whether the design is disclosed in accordance with the relevant regulations by taking into consideration the article that embodies the design and checking the drawings, photographs, etc., submitted by the applicant.
- If we conduct to find design and determine that the design fails to satisfy the substantive requirements for design registration (e.g., the case where the design clearly lacks novelty), we conduct substantive examination as well

Answer Section 3- 1

In the course of formality examination on the design claimed in an application, we engage in no conduct to find the design. (assuming “find the design” means as a result of searching)

When the application is initially filed, the office of initial patent examination (OIPE) reviews the application to determine whether it includes drawings and a short specification but does not provide a detailed review of formalities.

出願でクレームした意匠に関する方式審査の過程では、「find the design」は行っていない
（「find the design」は、探して見つけるという意味に解釈）

出願がされると初期審査室（OIPE）が出願を審査するが、それは図面や簡潔な明細書が添付されているかどうかを見るためのもののものであって、方式の詳細な審査を行うものではない。

The patent examiner provides a detailed review of the application for formalities and performs the substantive examination, such a review of novelty and obviousness. The examiner reviews the drawings to make sure that the views are consistent and that the drawings clearly convey the design. If features are not supported by the original drawings, the Examiner may require these features to be provided in broken lines.

特許審査官が、出願方式の詳細な審査と、新規性や非自明性の実体審査を行う。審査官は各図面の整合がとれているか、また図面は明確に意匠表現しているかを審査する。もし当初出願された図面で特徴がサポートされていなければ、審査官はそれらの特徴を破線性表現をするように要求するかもしれない。

Question 3-2 Who conducts the formality examination mentioned in Question 3-1? Is it conducted by a formality examiner, Office staff member, or any other staff member (including a substantive examiner)? Please specify.

Answer Section 3-2

The patent examiner

特許審査官

Question 3-3 Do you have a system to invalidate a registered design right on the grounds that the design is unclear for such reasons as the design right having an unidentifiable scope? Example answers are listed below. Please give us a detailed answer.

- System to file a request with the IP Office for commencement of examination
- System to file a request with the IP Office for an invalidation trial
- System to file a lawsuit with a court

Answer Section 3-3

No current system. In the future, the Post Grant Review system will allow invalidation of design that has an effective filing date on or after March 16, 2013.

現時点ではない。将来的には、権利付与後レビュー制度により、2013年3月16日以降の有効な出願日を有する意匠の無効化が可能になる。

Question 3-4 Is there any judicial precedent where the clarity of a design representation was at issue? If yes, please summarize the judgment and tell us the grounds on which the court found the design representation to be unclear.

Answer Section 3-4

Philco Corporation V. Admiral Corporation, 131 USPQ 413 (DC Del 1961)

In this lower court case, several patents were found invalid, one for insufficient disclosure.

Design No. 183,692 was found invalid because the disclosure lacked a drawing of the back, which was considered an integral part of the design. The court stated:

Not only is the creation of the '692 design conditioned upon use of a configured back, but its very appearance depends upon what configuration the back takes.

この下級審裁判では、複数の特許が無効とされ、1件は開示不十分によるものであった。意匠 No.183,692 は、当該意匠に不可欠と考えられる背面図が開示されていないという理由で無効とされた。判決では次のように述べている。

「この意匠の作成において、背面の形態を使用することが必要であるだけでなく、背面がどのような形態を取るかによって、外観そのものが左右される」

Question 4 Principle concerning amendments

Question 4-1 Is it permitted to amend a design application? If yes, what restrictions are imposed on an amendment in terms of time schedule and content? Please tell us any restrictions imposed on an amendment in practice other than those specified in the laws, regulations, examination guidelines, etc., that we should know about. Furthermore, is it permitted to make a voluntary amendment?

Answer Section 4-1

Voluntary amendments are permitted before the first office action. Amendments are generally permitted until a final office action, at which time amendments are generally limited to those that would place the application in condition for allowance or better form for appeal. Amendments are permitted as long as no new matter is added. New matter is subject matter that does not find support in the original drawings and description.

最初のオフィスアクションの前であれば、自発的な補正が認められる。通常、補正が認められるのは、最後のオフィスアクションまでであり、この時点では補正は、出願を許可される状態にするものや、審判のために体裁を整えるものに限定される。

補正は、新たな事項が追加されない限り認められる。新たな事項とは、最初の図面や明細書に裏付けがない対象物である。

Question 4-2 What may be submitted to make an amendment? Please tell us what may be submitted in practice other than those specified in the laws, regulations, examination guidelines, etc.

Answer Section 4-2

In general, an amendment includes a complete set of replacement drawings, a description of any amendments to the specification, and any remarks or arguments made by the applicant.

補正には一般に、差し替えの図面、明細書を補正する記述、出願人による意見または申立が含まれる。

Question 4-3 If the IP Office refuses to accept any amendment made in response to an amendment order or made voluntarily, what action would the IP Office take? Is there a possibility that the IP Office dismisses the design application? Or, if only a minor defect is involved, would the IP Office accept amendment and register the application which was amended?

The USPTO would send an office action rejecting the claim if the amendment does not overcome all rejections in a previous office action. If the amendment does not overcome all rejections, then the applicant will need to either file a Continuation application with further amendments or appeal the rejections.

If the defect is only minor, the Examiner will normally contact the Applicant asking for authorization to make an Examiner's Amendment that would place the application in condition for allowance.

前回のオフィスアクションによる拒絶理由が、補正によってすべて克服されていない場合、USPTO はオフィスアクションによってクレームを拒絶する。補正によってすべての拒絶理由が克服されない場合、出願人は、さらなる補正によって継続出願を行うか、拒絶に対して審判請求する必要がある。

瑕疵が軽微な場合は、審査官が、出願を許可される状態にする補正を行うため、出願人に連絡して許可を求める。

Question 4-4 Even though a design application is satisfied the formality requirements, are there any cases where the IP Office sends the applicant a instruction for an amendment related to a representation of the design in order to facilitate to conduct finding the design or to make the representation of the design more accurate? Please tell us what is stated in such a request in detail.

Answer Section 4-4

Sometimes, an office action will include an Examiner's explicit suggestion for amending the drawings and/or specification. For example, the Examiner might recommend that certain features are unclear and should be provided in broken lines.

オフィスアクションには、図面／明細書の修正に関する審査官の明確な提案が含まれる場合もある。例えば、ある特徴が不明確であるとして、破線で示すよう提案することも考えられる。

Question 4-5 In the case mentioned in Question 4-4, if the IP Office sends an instruction to an applicant, is the applicant required to make an amendment strictly in accordance with the instruction? Or, is the applicant permitted to make an amendment in the way he/she wishes to a certain extent? Please explain in detail.

Answer Section 4-5

The applicant is not required make the amendment recommended by the Examiner but could traverse the rejection or amend the drawings and/or specification in a different manner.

審査官が提案した補正は必須というわけではなく、これに従わず、異なる形で図面／明細書を補正することも可能である。

Question 4-6 Is it permitted for a design applicant to divide the application and file a divisional application as a new design application? If we yes, what restrictions are imposed on the filing of a divisional application in terms of time schedule and content? Please tell us any restrictions imposed in practice other than those specified in the laws, regulations, examination guidelines, etc., that we should know about. For instance, is it permitted to divide a design application for a whole article and file a divisional design application for a new part or component?

Answer Section 4-6

Yes. A divisional or continuation application can be filed. A divisional or continuation application must be filed during the pendency (i.e., before allowance or abandonment) of a patent application, or another continuation or divisional application. The subject matter in the divisional or continuation application must find support in the patent application.

分割／継続出願を行うことは可能。分割／継続出願は、特許出願、または別の分割／継続出願の係属中（つまり、許可または放棄の前）に提出しなければならない。分割／継続出願の対象物は、特許出願の中に裏付けがなければならない。

Question 4-7 Before the according of the application filing date, is it necessary for the applicant to satisfy the requirements for representation of a design and a design should be found? Or, may the application filing date be accorded without finding a design as long as the formality requirements are satisfied (e.g., the number and size of drawings or photographs)?

Answer Section 4-7

The application is generally granted a filing date even if all requirements for patentability are not satisfied. If, however, there is a major problem, such as no drawings being submitted, the application will be granted a filing date as of the date that the defect is corrected (e.g., drawings being submitted).

通常、すべての特許性要件が満たされなくても、出願日は認定される。ただし、図面が提出されていないというような大きな問題がある場合は、その不備が是正された（例：図面が提出された）日が、出願日として認定される。

Question 4-8 In the case specified in Question 4-7, after an applicant makes an amendment in response to an order for amendment that the IP Office issued on the grounds that the requirements for according the application filing date were not satisfied, if said requirements are satisfied as a result of the amendment, which date does the IP Office accord as the application filing date, either the first application filing date or the date on which the amendment was submitted?

Answer Section 4-8

If there is a major problem, the application will be granted a filing date as of the date that the defect is corrected.

大きな問題があった場合は、その瑕疵が是正された日が出願日として認定される。

Question 4-9 In the case of an IP Office that conducts to find a design as a prerequisite for according the application filing date, please answer this question. In the case of any other IP Office, please skip this question and answer Question 5.

In the case mentioned in Question 4-8, if an amendment submitted to the IP Office changes the gist of the design, how would the amendment be treated? Would it be dismissed? Or, would it be deemed as a new application filed on the date on which the written answer to the order for amendment is submitted? Please explain in detail.

Answer Section 4-9

Question 5 Principle of unity

Question 5- 1 Please tell us the requirements for representations of designs in order for multiple designs to be regarded as a single design.

Please give us a detailed answer. For example, is it the case that the designs of articles that are used in a physically separated manner may be regarded as a single design as long as those designs are regarded as a set in terms of design (e.g., a set of stackable pans), that a set of similar designs may be regarded as a single design as long as those designs are similar to each other in terms of configuration¹, that the designs represented in a drawing in a physically separated manner may be regarded as a single design as long as those articles are used simultaneously (e.g., a pen and its cap), or that the designs of different articles may be regarded as a single design as long as they are used simultaneously (e.g., a stationary article and its base)? Which requirements, either formality requirements (formality examination) or substantive requirements (substantive examination), must be met in order to recognize multiple designs as a single design? If multiple designs are not regarded as a single design, how would the IP Office treat them?

¹ “Configuration” means here that the shape, patterns or colors, or any combination thereof, of an article. The same shall apply hereinafter.

(Example) In Japan, a design application would be dismissed (i) if the applicant states two or more classifications of articles in the section entitled "Article which constitutes the design" of an application, (ii) if the applicant presents drawings of two or more articles, or (3) in the case of an application for the design of a part of an article, if the application covers two or more physically separated parts. If an application is dismissed for any of the aforementioned reasons, the applicant may file a divisional application (substantive requirements).

Answer Section 5-1

A design right protecting multiple designs would have to include designs that are not patentably distinct from one another and, therefore, form a single inventive design concept. The specification should make clear that multiple embodiments are disclosed and should particularize the differences between the embodiments. See MPEP 1504.05.II.A. If multiple designs are considered patentably distinct, then the Examiner. Will make a restriction requirement The applicant would have the right to file divisional applications directed to any designs that are not elected.

複数の意匠を保護する意匠権には、特許としては互いに異なっていないために、単一の進歩性の概念を有する意匠が含まれる必要がある。明細書では、複数の実施態様を開示したことを明確にし、実施態様間の違いを詳述する必要がある。MPEP 1504.05.II.A を参照。複数の意匠が特許として異なると見なされる場合、審査官は減縮を求める。出願人には、選択しなかった意匠に対して分割出願を行う権利がある。

Question 5-2 This is a question to the IP Office of any country that protects images. If your country does not protect images, please skip this question and answer Question 6.

Please tell us the provisions concerning representations of drawings that are required to be made in order to have multiple images regarded as a single design. Which requirements, either formality requirements (formality examination) or substantive requirements (substantive examination), must be met in order to have multiple images regarded as a single design? If multiple images are not regarded as a single design, how would the IP Office treat them?

(Example) In Japan, multiple images may be regarded as a single design covering multiple images in the case where the image before a change and the image after the change are used in relation to the same function of an article as long as those two images are considered to be related to each other in terms of configuration. If multiple images are not regarded as a single design, the application would be dismissed on the grounds that multiple images should be regarded as multiple designs (substantive requirements).

Answer Section 5-2

Multiple images can be regarded as part of a single design. See Section 6-4 below. In this situation, the specification must describe the order in which the design changes.

複数の画像を一意匠の一部とみなすことは可能である。下記 Section 6-4 参照。この場合は、明細書において、意匠が変化する順序を説明しなければならない。

Question 6 Scope of design protection

Question 6-1 Based on what definitions or ideas concerning the similarity of the configurations of designs do you determine the scope of design protection? Please give us any judicial precedent where the court presented its interpretation about how to interpret the scope of design protection from the perspective of configuration similarity, for example, whether the scope of design protection only covers almost identical designs or covers designs of different degrees of similarity (variations).

Answer Section 6-1

As stated in the Supreme Court Decision *Gorham v. White* 81 US 511, 523 (1871) more than 100 years ago, the basic standard for determining infringement of a US design patent is:

[I]n the eye of an ordinary observer, giving such attention as a purchaser usually gives, two designs are substantially the same, if the resemblance is such as to deceive such an observer, inducing him to purchase one supposing it to be the other, the first one patented is infringed by the other.

More recently, in *Egyptian Goddess Inc. v. Swissa Inc.*, 43 F.3d 665, 88 USPQ2d 1658, 1667 (Fed. Cir. *en banc* 2008) the *en banc* Court of Appeals for the Federal Circuit explained that the ordinary observer test is the single test for determining infringement of a design patent and that this test must also include a consideration of the existing prior art. Thus, the test for infringement of a US design patent is “whether an ordinary observer, familiar with the prior art designs, would be deceived into believing that the accused product is the same as the patent design.” See *Richardson v. Stanley Works Inc.*, 93 USPQ2d 1937, 1941 (Fed. Cir. 2010).

「*Gorham v. White* 81 US 511, 523 (1871)」の裁判における最高裁判決で述べられているように、100年以上前の米国意匠特許の侵害を判断する根本的な基準は次のようなものである。

「購買者としての通常の注意を払った、通常の観察者の目から見て、特許意匠と侵害被疑意匠が実質的に同一であり、被疑意匠を特許意匠のデザインと間違えて購入するように誤信させるほど類似している場合には、特許意匠は被疑意匠により侵害されているといえる」より最近では、「*Egyptian Goddess Inc. v. Swissa Inc.*, 43 F.3d 665, 88 USPQ2d 1658, 1667 (Fed. Cir. *en banc* 2008)」の裁判において CAFC 大法廷は、「通常の観察者」テストは意匠特許侵害を判断する唯一のテストであり、既存の先行意匠も考慮に入れなければならないと説明した。したがって、米国意匠特許の侵害に関するテストは、「先行意匠に明るい通常の観察者が欺かれて、被疑製品が特許意匠と同じであると思いつかどうか」である。*Richardson v. Stanley Works Inc.*, 93 USPQ2d 1937, 1941 (Fed. Cir. 2010)を参照。

Question 6-2 Please explain in detail how the scope of design protection is affected by the identity or similarity of articles or by the identity or similarity of the functions and use of articles. Please give us any judicial precedent where the court presented its interpretation as to how the scope of design protection is affected by these factors.

Answer Section 6-2

Similarity of articles- *Crocs Inc. v. International Trade Commission*, 598 F.3d 1294, 93 USPQ2d 1777, 1783 (Fed. Cir. 2010) stated:

When the differences between the claimed and accused designs are viewed in light of the prior art, the attention of the hypothetical ordinary observer may be drawn to those aspects of the claimed design that differ from the prior art. If the claimed design is close to the prior art designs, small differences between the accused design and the claimed design assume more importance to the eye of the hypothetical ordinary observer. The ordinary observer, however, will likely attach importance to those differences depending on the overall effect of those differences on the design. Even if the claimed design simply combines old features in the prior art, it may still create an overall appearance deceptively similar to the accused design. In that case, this court will uphold a finding of infringement.

物品の類似—*Crocs Inc. v. International Trade Commission*, 598 F.3d 1294, 93 USPQ2d 1777, 1783 (Fed. Cir. 2010)では、次のように述べている。

クレームされた意匠と被疑意匠の違いを、先行意匠に照らして見た場合、架空の通常の観察者の注意は、先行意匠と異なるクレーム意匠の側面に向けられると考えられる。クレーム意匠が先行意匠に類似している場合、被疑意匠とクレーム意匠のわずかな違いは、架空の通常の観察者の目にとってより重要となる。しかし、通常の観察者がそうした違いを重視するかどうかは、その違いが意匠に与える全体的な影響によって左右されるものと考えられる。クレーム意匠が、先行意匠の古い特徴を組み合わせただけのものであっても、全体的外観が被疑意匠と類似しているように見えることもある。その場合、当裁判所は侵害の認定を支持する。

Functionality- In 1997, the Federal Circuit in *Oddz On Products v. Just Toys Inc.*, 122 F3d 1396, 43 USPQ2d 1641, 1647 (Fed. Cir. 1997), stated:

Where a design contains both functional and non-functional elements, the scope of the claim must be construed in order to identify the non-functional aspects of the design as shown in the patent.

In 2010, the Federal Circuit in *Richardson v. Stanley Works, Inc.*, 597 F3d 1288, 93 USPQ2d 1937, 1941 (Fed. Cir. 2010), stated that the district court had "properly factored out the functional aspects of Richardson's design as part of its claim construction" and that a "claim to a design containing numerous functional elements, such as here, necessarily mandates a narrow construction."

機能—*Oddz On Products v. Just Toys Inc.*, 122 F3d 1396, 43 USPQ2d 1641, 1647 (Fed. Cir.

1997)において、CAFCは次のように述べている。

「意匠に機能的要素と非機能的要素が含まれる場合、クレームの範囲は、当該特許に示されているように、意匠の非機能的な側面に関するものとして解釈しなければならない」

2010年の *Richardson v. Stanley Works, Inc.*, 597 F3d 1288, 93 USPQ2d 1937, 1941 (Fed. Cir. 2010)において CAFC は、地裁が「Richardson の意匠の機能的な側面を、クレーム構成から適切に除外している」と述べ、また、本件のように、数多くの機能的要素を含む意匠は、必然的に狭い構成が要求される」と述べた。

Question 6-3 Please explain in detail how the scope of design protection is affected by the parts of an article that are not represented in drawings or photographs.

Answer Section 6-3

Parts of the article that are not shown do not limit the scope of protection. Moreover, parts of the article that are not claimed (e.g., provided in broken lines) also do not limit the scope of protection.

物品において表されていない箇所が、保護の範囲を限定することはない。また、クレームされていない箇所（例：破線で示されている箇所）が、保護の範囲を限定することもない。

Question 6-4 In the case of a design right for an article which partially changes to perform its functions, does the scope for design protection cover the configurations observed in the course of change? Or, does the scope of design protection cover only the configuration before a change and the configuration after the change?

The following is a specific example where a part of an article (toy) that has a three-dimensional configuration changes its configuration to perform its functions.

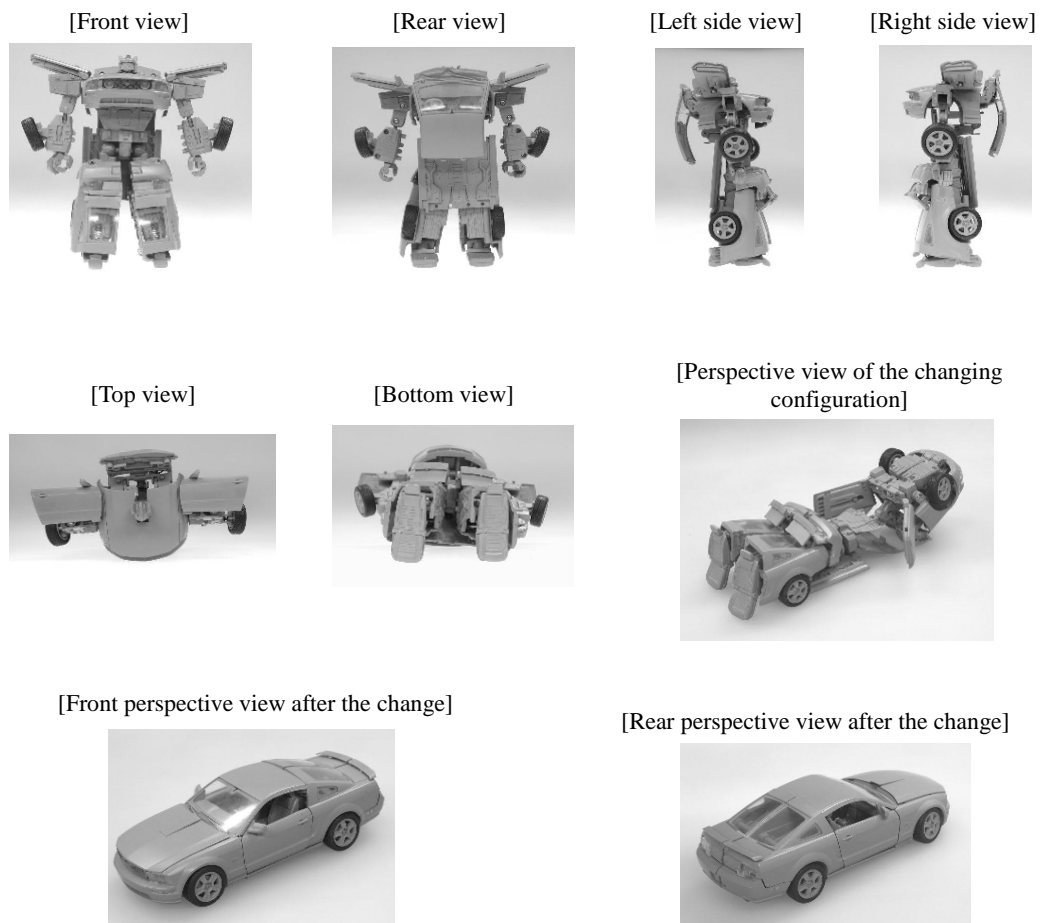

Answer Section 6-4

This can be filed as a single design. Example descriptions are provided below:

FIG. 1 is a front view of a transforming toy vehicle in a first configuration in accordance with the new design; ...

FIG. 7 is a perspective view of a transforming toy vehicle in a second configuration in accordance with the new design ...

これは一意匠として出願できる。記載の例を以下に示す。

図 1 は、形状が変化する車のおもちゃの、新たな意匠に基づく 1 つめの形態の正面図であり...

図 7 は、形状が変化する車のおもちゃの、新たな意匠に基づく 2 つめの形態の斜視図であり...

Question 6-5 This question is about the scope of design protection in the case of a set of articles or a certain set of articles. Does the design protection only cover a set of articles or a certain set articles? Or, does the design protection also cover each article that comprises a set?

If simultaneously used multiple articles are coordinated as a whole, the designs of those articles may be regarded as a single design. Such a design may be regarded as a "design for a set of articles." The term "a design for a certain set of articles" is conceptually the same as "a design for a set of articles." The term "a design for a certain set of articles" refers to a design used for any of the prescribed types of set.

Answer Section 6-5

The design protection for a set of articles covers the set itself including all articles of the set and does not cover only the individual articles of the set.

セットものに対する意匠保護は、そのセットのすべての物品を含むセット自体に効力が及び、セットの個々の物品のみには及ばない。

Question 6-6 This is a question about the restrictions on the exercise of design rights that are related to each other in conflict of which both right holders and both filing dates are deferent.

Design rights are considered to be related to each other in conflict in the following three cases:

- (i) a design right to protect the design of a whole article and a design right to protect the design of a component of the article (the component can be regarded as an independent article). Filing date of the design right of a component of the article is earlier than filing date of the design right of a whole article. Both rights are owned by deferent persons;
- (ii) a design right to protect the design of a whole article and a design right to protect the design of a part of the article (a part means a portion of the article and cannot be separated as a component). Filing date of the design right of a part of the article is earlier than filing date of the design right of a whole article. Both rights are owned by deferent persons; and
- (iii) a design right to protect the design of a set of articles or a certain set of articles and a design right to protect the design of any article that comprises a set. Filing date of the design right of any article that comprises a set is earlier than filing date of the design right of a set of articles or a certain set of articles. Both rights are owned by deferent persons.

For example, in Case (i) above, if the holder of a design right to protect the design of a whole article works the design or exercises the design right, is it sometimes necessary for him/her to obtain a license from the holder of a design right to protect the design of a component? How about the situations in Case (ii) and Case (iii) described above in terms of the restrictions on the exercise of design rights?

Answer Section 6-6

Yes. In each of cases (i),(ii), and (iii), it may be necessary for the holder of a design right to the whole article or set of articles to obtain a license from the holder of design to the component, part, or individual article.

ある。(i)、(ii)、(iii)の各ケースにおいて、物品全体またはセットの意匠権者が、部品または個々の物品の意匠権者からライセンス許諾を受けることが必要になる場合がある。

Question 6-7 This is a question to the IP Office of any country that protects multiple images as a single design.

If your country does not protect multiple images as a single design, please skip this question and answer Question 7.

In the case of two related design rights, i.e., a design right to protect the designs of multiple images and a design right to protect the design of any of those images, are in conflict. Filing date of the design right of any of those images is earlier than filing date of the designs right of multiple images. Both rights are owned by deferent persons. In this case, are any restrictions imposed on the exercise of those design rights?

Answer Section 6-7

Our understanding is that the design right protecting multiple designs includes designs that are not patentably distinct from one another and, therefore, form a single inventive design concept. If a design application including only one of the multiple designs is filed before the design including multiple images, the design including multiple images will be anticipated and thus not patentable.

我々の認識では、複数の意匠を保護する意匠権には、特許として互いに異なっていないために、単一の進歩性の概念を形成する意匠が含まれる。複数の画像を含む意匠を出願する前に、そうした複数の意匠のうちの1つのみを含む意匠出願が提出された場合、複数の画像を含む意匠は新規性がなくなるため、特許性がない。

Question 6-8 This is a question to the IP Office of any country that protects multiple images as a single design and conducts substantive examination. If your country does not protect multiple images as a single design and does not conduct substantive examination, please skip this question and answer Question 7.

In case of an application seeking for a protection of a design of multiple images When filing date of an application seeking for a protection of design of any those images is earlier than filing date of an application seeking for a protection of a design of multiple images, and both applicants are different, what measures do you take when determining whether such a design has novelty and is not easily creatable by any person skilled in the art?

Answer Section 6-8

If a design application including only one of the multiple designs is filed before the design including multiple images, the design including multiple images will be anticipated and thus not patentable.

複数の画像を含む意匠を出願する前に、そうした複数の意匠のうちの 1 つのみを含む意匠出願が提出された場合、複数の画像を含む意匠は新規性がなくなるため、特許性が無い。

Question 7 Disclosure by drawings included in application documents and publication by gazettes

Question 7-1 Are there any cases where a drawing or photograph included in application documents is edited (e.g., altered in size or ratio) when the design is publicized in a design gazette (including an electronic gazette)? If editing is conducted, please tell us the reasons and standards for editing.

Answer Section 7-1

Drawings are not edited before publication.

公開前に図面が加工されることはない。

Question 7-2 If a design application is filed by an electronic medium, do you store printed-out hardcopies of the representations of the design as the original documents in addition to the submitted electronic images of those representations? If yes, why?

Answer Section 7-2

No. The electronic file wrapper includes .pdf documents for the drawings and documents. But the original images are stored in an alternative .tif format, called SCORE.

保管しない。電子包袋には、図面および書類の PDF 文書が入っている。しかし、元の図面は SCORE と呼ばれる TIF 形式のファイルで保管する。

Question 7-3 Does the public have access to the documents (including electronic data) prepared in the course of design prosecution starting from the filing of a design application to the registration of the design? If yes, please tell us the inspection fee and conditions (to what extent is inspection permitted? Are there any documents that are not available for inspection?).

Answer Section 7-3

No. The public does not have access to the documents within the file wrapper until the design patent issues. Once the patent issues, the documents can be viewed and downloaded from the PTO's website.

包袋の書類は、意匠特許が交付されるまでは閲覧できない。特許が交付されたら、特許庁のサイトから閲覧、ダウンロードできる。

Question 8 Do you receive any opinions from users of the design system such as a request for a revision of the design system in order to change the way of representing a design in a design application under the relevant laws, regulations, and examination guidelines of your country and to remedy the current situation where the way of representing a design differs from one country to another? If yes, please describe those opinions in detail.

Answer Section 8

????

Question 9 In recent years, has the number of design applications been on the rise or on the decline?
What do you think has caused such increase or decrease?

Answer Section 9

See link: http://www.uspto.gov/web/offices/ac/ido/oeip/taf/us_stat.htm

As shown in Table A1-1a the number of design patent applications has been increasing recently from 20,904 in 2002 to 30,467 in 2011.

上記リンク先の Table A1-1a に示されているように、意匠特許出願件数は、2002 年の 20,904 から、2011 年の 30,467 へ増加している。

Question 10 If your country has signed the Hague agreement, please answer this question. Did the number of design applications increase or decrease in your country before and after the signing of the Hague agreement?

Answer Section 10

Hague Agreement was signed by the US more than 12 years ago. As shown in the link above design patent applications have been increasing both before and after the signing of this agreement.

米国は 12 年以上前にヘーグ協定に調印している。上記のリンク先の表に示されているように、意匠特許件数は、協定調印の前も後も増え続けてきた。

Question 11 If your country has signed the Hague agreement, please skip this question and answer Question 12.

This is a question to the IP Office of any country that is planning to sign the Hague agreement. What are your purposes for signing the Hague agreement? Please describe your purposes in detail.

Answer Section 11

Question 12 Please answer this question if your country has signed the Hague agreement or is planning to do so. In order to sign the Hague agreement, did you have to make any alterations or adjustments to your country's system? Or, is your country planning to alter or adjust your country's system in the future?

Answer Section 12

There is a proposed law change, HR 6432, that was introduced on September 19, 2012, to implement the Hague Agreement. This law change is not final.

2012年9月19日に、ヘーグ協定を実施するための法改正案 HR 6432 が提出された。この法改正はまだ終わっていない。

[Request for information]

- 13** If your country has adopted a multiple design application system, please send us information on how an application and drawings should be prepared in order to file a multiple design application. We would appreciate if you could send us a sample application and a sample drawing that are available for disclosure (those with all the sections filled in with information as a sample). If such application and drawing are not available for disclosure, please send us a blank application form, etc., if possible.
- 14** Is it possible for you to send us a sample registration certificate? Again, we would appreciate if you could send us such a certificate with all the sections filled in with information as a sample. If such certificate is not available for disclosure, please send us a blank certificate form, if possible.

The
United
States
of
America



The Director of the United States
Patent and Trademark Office

Has received an application for a patent for a new, original, and ornamental design for an article of manufacture. The title and description of the design are enclosed. The requirements of law have been complied with, and it has been determined that a patent on the design shall be granted under the law.

Therefore, this

United States Patent

Grants to the person(s) having title to this patent the right to exclude others from making, using, offering for sale, or selling the design throughout the United States of America or importing the design into the United States of America for the term of fourteen years from the date of grant of this patent, subject to any disclaimer under 35 U.S.C. 253.

David J. Kayros

Director of the United States Patent and Trademark Office



US00D670651S

(12) **United States Design Patent**
Mori et al.

(10) **Patent No.:** **US D670,651 S**

(45) **Date of Patent:** **** Nov. 13, 2012**

(54) **ELECTRIC CONNECTOR**

(75) Inventors: **Shigeo Mori**, Kakegawa (JP); **Junya Nakano**, Shimada (JP)

(73) Assignee: **Yazaki Corporation**, Tokyo (JP)

(**) Term: **14 Years**

(21) Appl. No.: **29/406,581**

(22) Filed: **Nov. 16, 2011**

(30) **Foreign Application Priority Data**

May 17, 2011 (JP) 2011-011018

(51) **LOC (9) Cl.** **13-03**

(52) **U.S. Cl.** **D13/133**

(58) **Field of Classification Search** D13/107-108,
D13/118-119, 133, 146, 147, 154, 184, 199;
D23/226; 320/104, 107-115; 439/34, 266,
439/310, 352, 372, 500, 660, 680, 700, 862
See application file for complete search history.

(56) **References Cited**

U.S. PATENT DOCUMENTS

D361,749 S * 8/1995 Fukao et al. D13/146
D370,461 S * 6/1996 Yoshioka et al. D13/146
D370,462 S * 6/1996 Fukao et al. D13/146
D373,110 S * 8/1996 Fukao et al. D13/146

D377,165 S * 1/1997 Yoshioka et al. D13/146
D378,292 S * 3/1997 Yoshioka et al. D13/146
D603,337 S * 11/2009 Katou et al. D13/120

OTHER PUBLICATIONS

U.S. Appl. No. 29/415,689, filed Mar. 13, 2012, Shigeo Mori.

* cited by examiner

Primary Examiner — Daniel Bui

(74) *Attorney, Agent, or Firm* — Sughrue Mion, PLLC

(57) **CLAIM**

The ornamental design for an electric connector, as shown and described.

DESCRIPTION

FIG. 1 is a perspective view of the front, top and right side of an electric connector showing our new design;
FIG. 2 is a perspective view of the rear, top and left side thereof;
FIG. 3 is a front view thereof;
FIG. 4 is a rear view thereof;
FIG. 5 is a right side view thereof, a left side view being a mirror image thereof;
FIG. 6 is a top view thereof;
FIG. 7 is a bottom view thereof; and,
FIG. 8 is a right side view thereof, in an alternate condition.
The broken line portion of the figure drawings is included for the purpose of illustrating environment and forms no part of the claimed design.

1 Claim, 6 Drawing Sheets

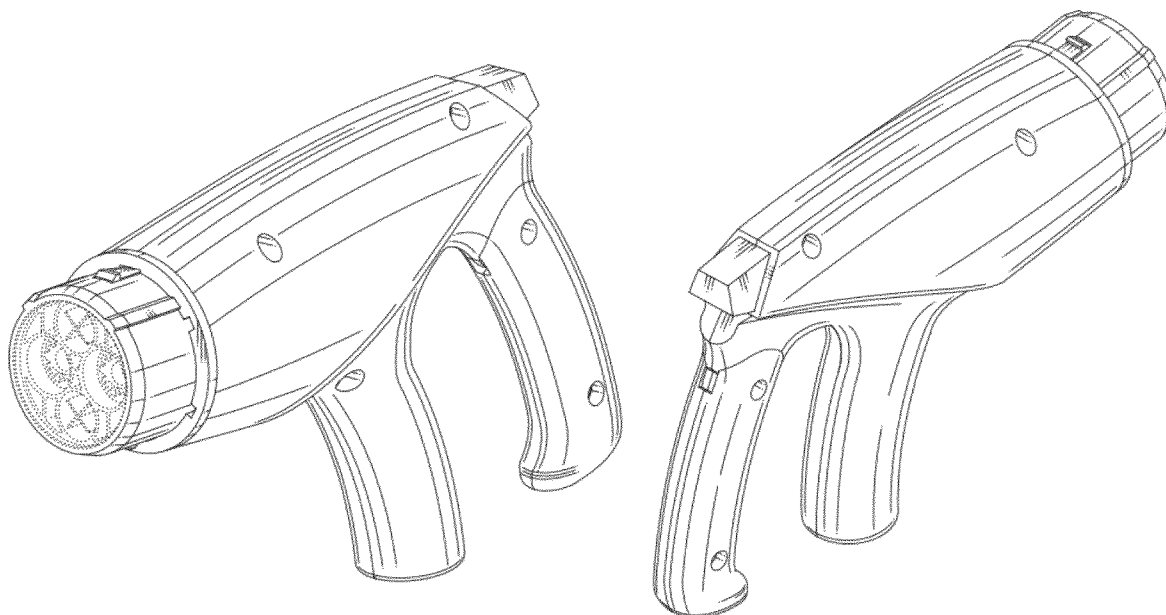

Fig. 1

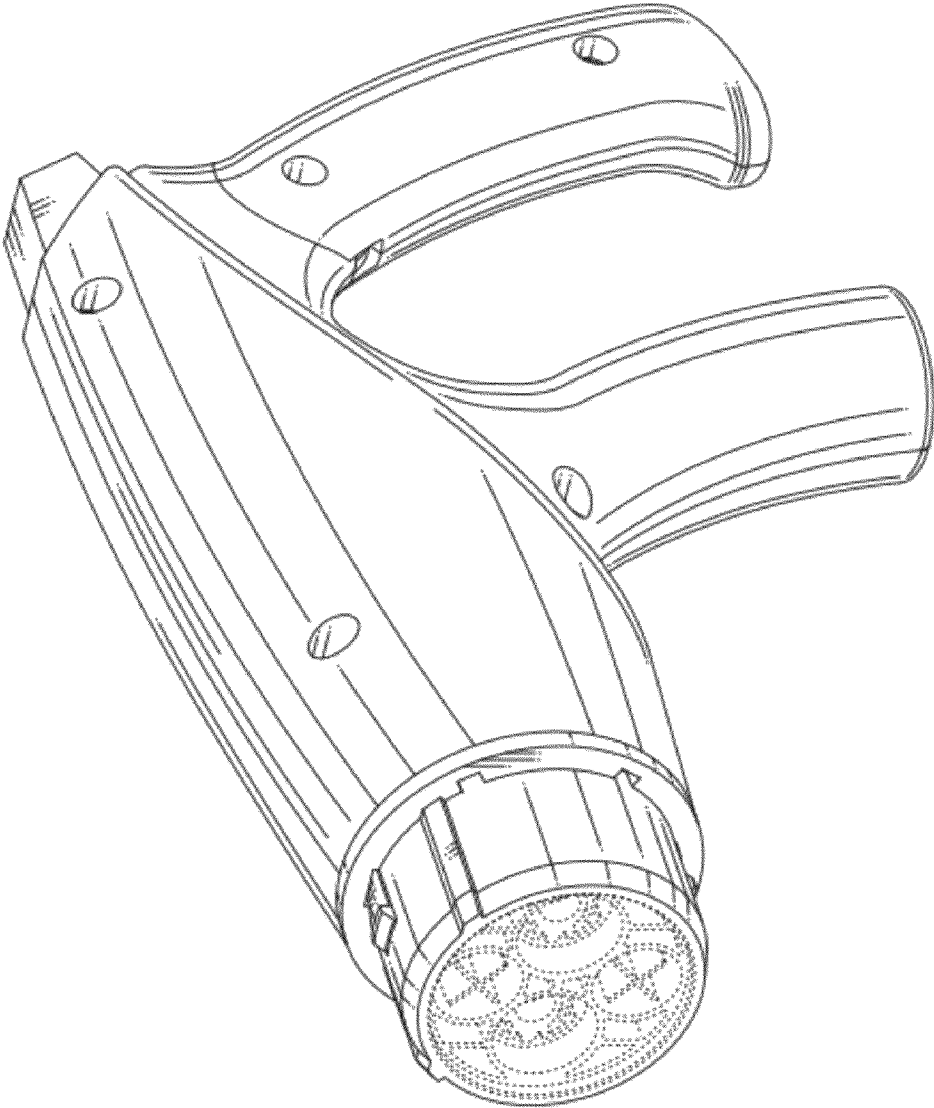

Fig. 2

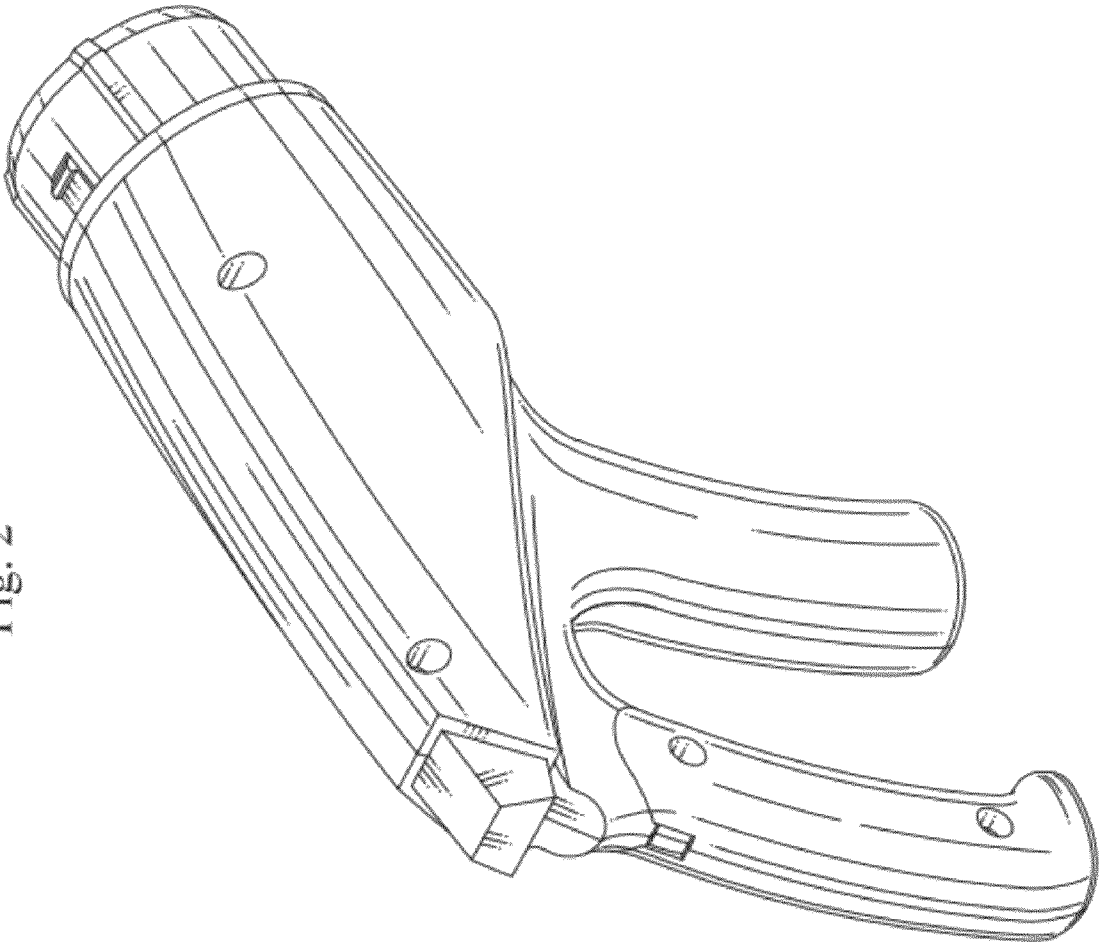

Fig. 4

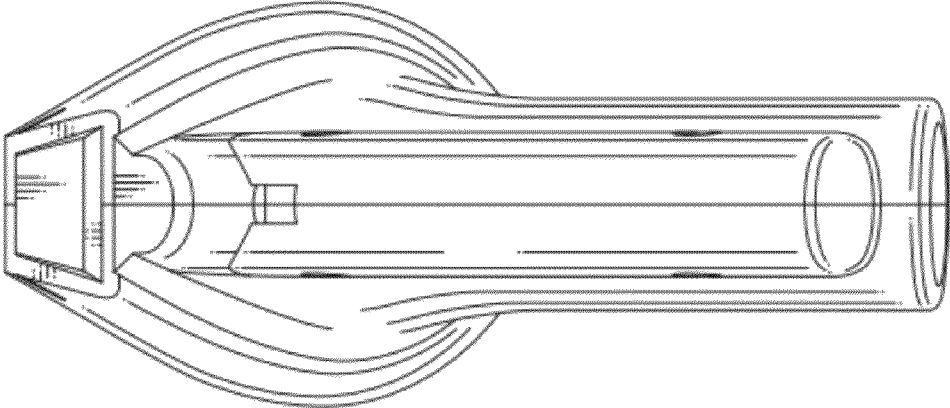

Fig. 3

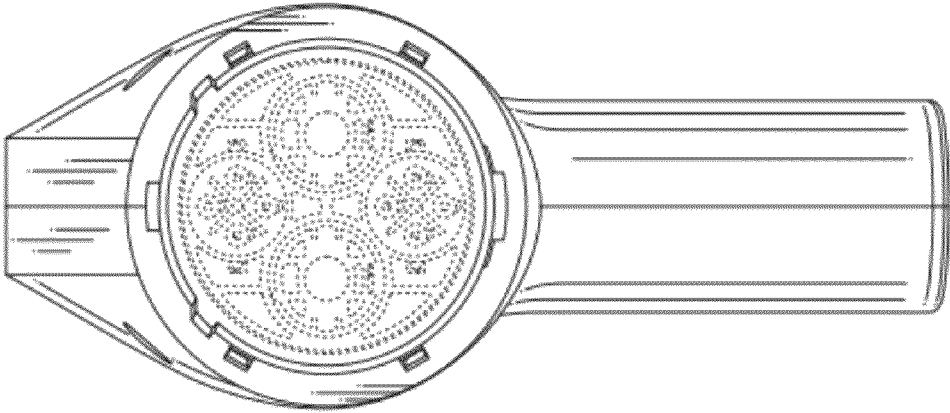

Fig. 5

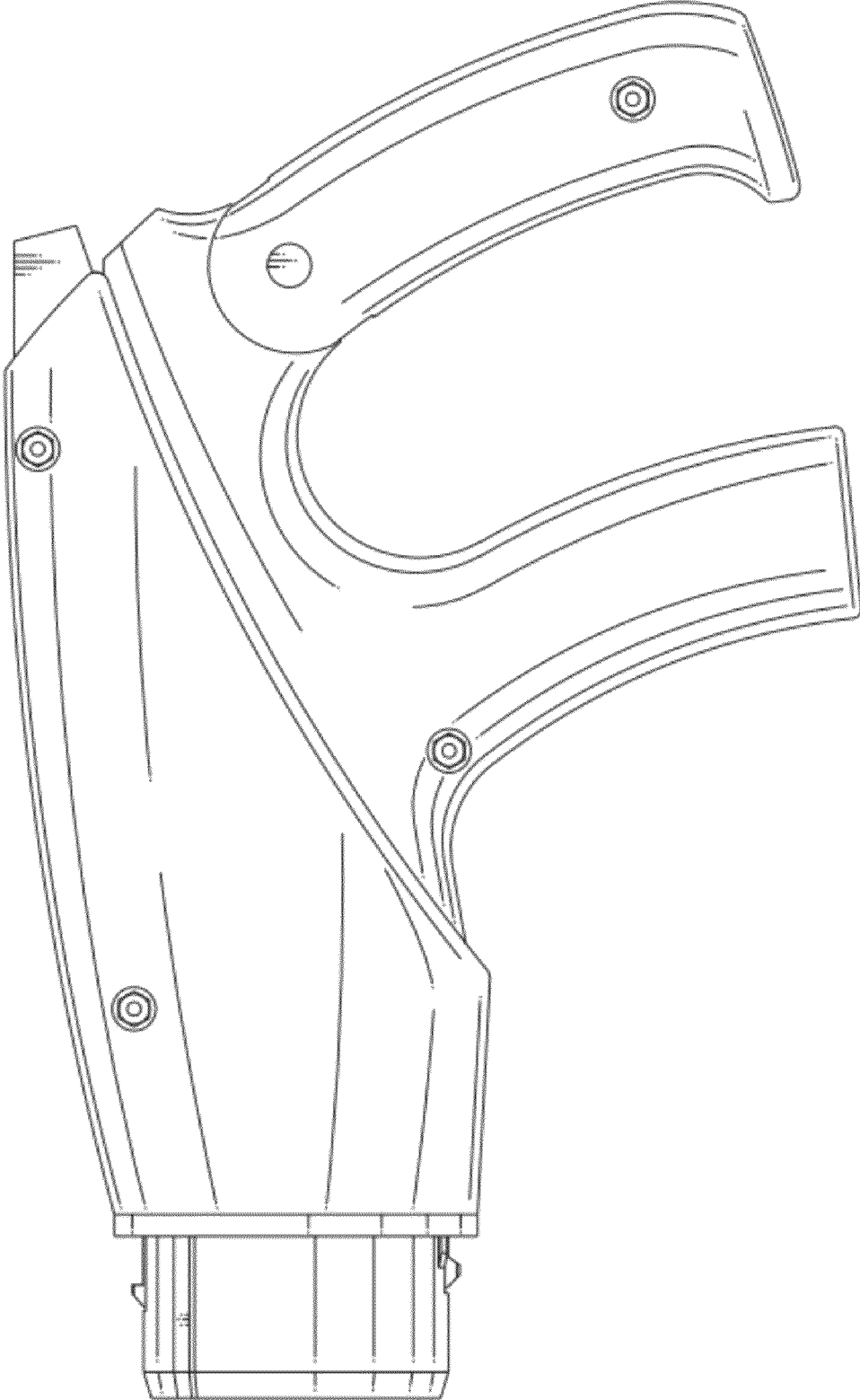

Fig. 6

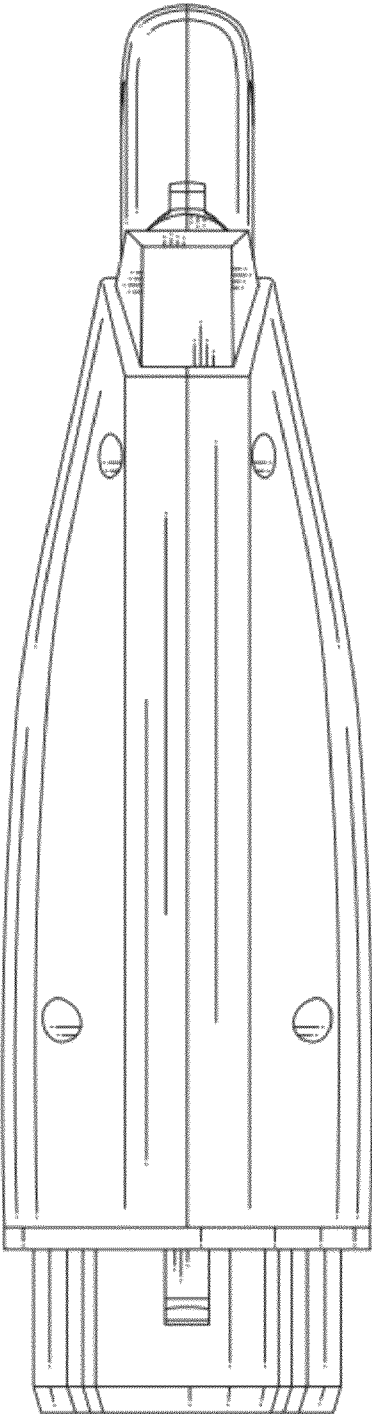

Fig. 7

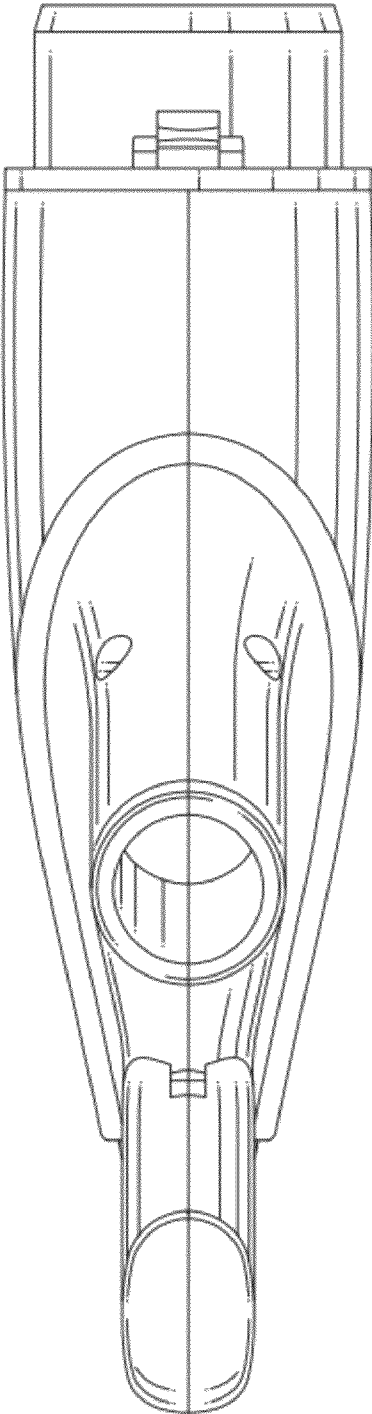
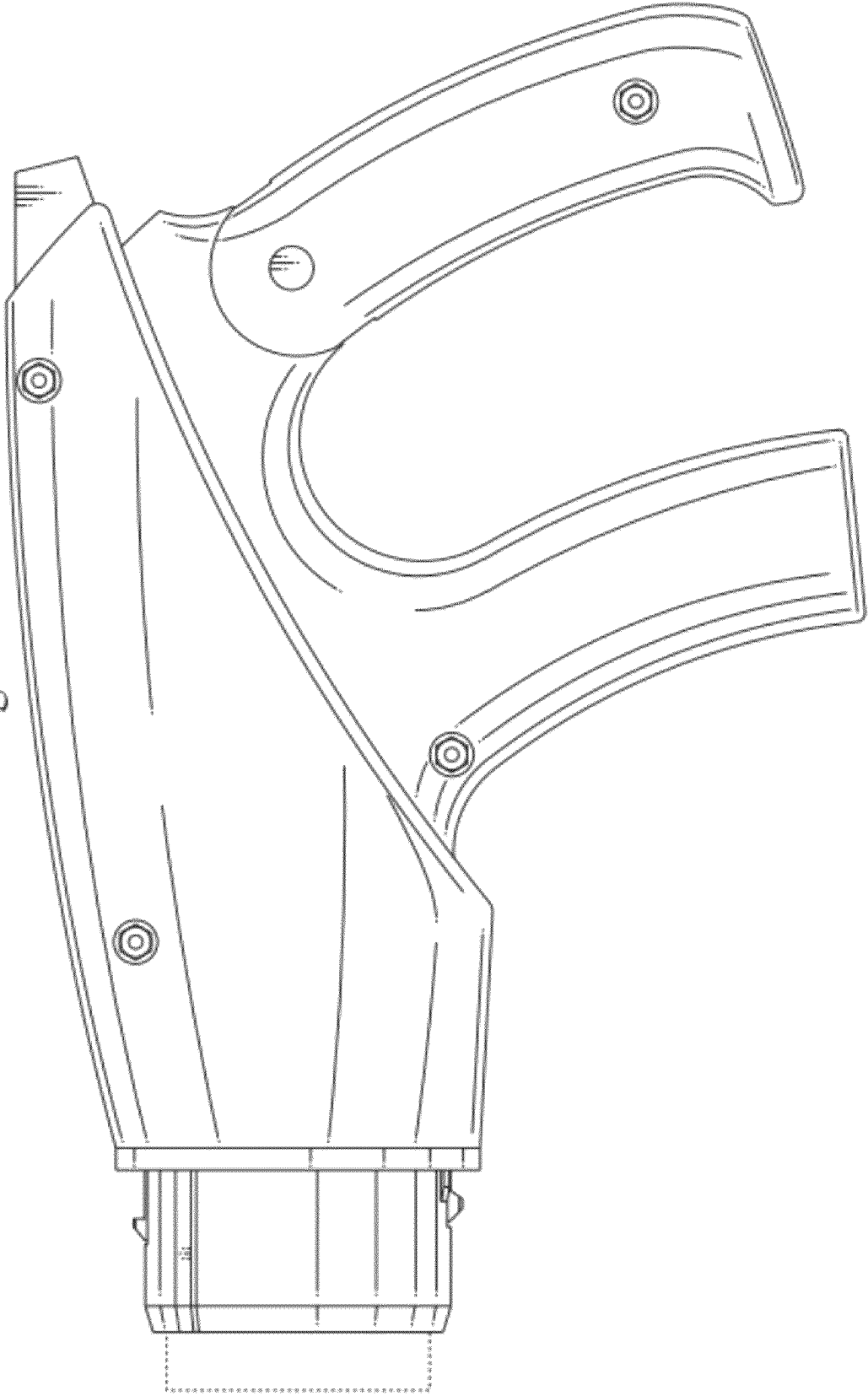

Fig. 8



Under the Paperwork Reduction Act of 1995, no persons are required to respond to a collection of information unless it displays a valid OMB control number.

**DESIGN
PATENT APPLICATION
TRANSMITTAL**

(Only for new nonprovisional applications under 37 CFR 1.53(b))

Attorney Docket No.

First Named Inventor

Title

Express Mail Label No.

ADDRESS TO:**Commissioner for Patents
P.O. Box 1450
Alexandria, VA 22313-1450****DESIGN V. UTILITY:** A "design patent" protects an article's ornamental appearance (e.g., the way an article looks) (35 U.S.C. 171), while a "utility patent" protects the way an article is used and works (35 U.S.C. 101). The ornamental appearance of an article includes its shape/configuration or surface ornamentation upon the article, or both. Both a design and a utility patent may be obtained on an article if invention resides both in its ornamental appearance and its utility. For more information, see MPEP 1502.01.**APPLICATION ELEMENTS**

See MPEP 1500 concerning design patent application contents.

1. Fee Transmittal Form (e.g., PTO/SB/17)
2. Applicant claims small entity status.
See 37 CFR 1.27.
3. Specification [Total Pages _____]
(preferred arrangement set forth below, MPEP 1503.01)
 - Preamble
 - Cross References to Related Applications
 - Statement Regarding Fed sponsored R & D
 - Description of the figure(s) of the drawings
 - Feature description
 - Claim (only one (1) claim permitted, MPEP 1503.03)
4. Drawing(s) (37 CFR 1.152) [Total Sheets _____]
5. Oath or Declaration [Total Pages _____]
 - a. Newly executed (original or copy)
 - b. A copy from a prior application (37 CFR 1.63(d))
(for continuation/divisional with Box 16 completed)
 - i. **DELETION OF INVENTOR(S)**
Signed statement attached deleting inventor(s) named in the prior application, see 37 CFR 1.63(d)(2) and 1.33(b)
6. Application Data Sheet. See 37 CFR 1.76

ACCOMPANYING APPLICATION PARTS

7. Assignment Papers (cover sheet & document(s))
8. 37 CFR 3.73(b) Statement (when there is an assignee) Power of Attorney
9. English Translation Document (if applicable)
10. Information Disclosure Statement (IDS)
PTO/SB/08 or PTO-1449
 Copies of foreign patent documents, publications, & other information
11. Preliminary Amendment
12. Return Receipt Postcard (MPEP 503)
(Should be specifically itemized)
13. Certified Copy of Priority Document(s)
(if foreign priority is claimed)
14. Request for Expedited Examination of a Design Application
(37 CFR 1.155) (NOTE: Use "Mail Stop Expedited Design")
15. Other:

16. If a CONTINUING APPLICATION, check appropriate box, and supply the requisite information below and in the first sentence of the specification following the title, or in an Application Data Sheet under 37 CFR 1.76: Continuation Divisional Continuation-in-part (CIP) of prior application No.: _____

Prior application information: Examiner _____ Art Unit: _____

17. CORRESPONDENCE ADDRESS The address associated with
Customer Number:

OR

 Correspondence address below

Name

Address

City

State

Zip Code

Country

Telephone

Email

Signature

Date

Name (Print/Type)

Registration No.
(Attorney/Agent)

This collection of information is required by 37 CFR 1.53(b). The information is required to obtain or retain a benefit by the public which is to file (and by the USPTO to process) an application. Confidentiality is governed by 35 U.S.C. 122 and 37 CFR 1.11 and 1.14. This collection is estimated to take 12 minutes to complete, including gathering, preparing, and submitting the completed application form to the USPTO. Time will vary depending upon the individual case. Any comments on the amount of time you require to complete this form and/or suggestions for reducing this burden, should be sent to the Chief Information Officer, U.S. Patent and Trademark Office, U.S. Department of Commerce, P.O. Box 1450, Alexandria, VA 22313-1450. DO NOT SEND FEES OR COMPLETED FORMS TO THIS ADDRESS. **SEND TO: Commissioner for Patents, P.O. Box 1450, Alexandria, VA 22313-1450.**

If you need assistance in completing the form, call 1-800-PTO-9199 and select option 2.

Privacy Act Statement

The **Privacy Act of 1974 (P.L. 93-579)** requires that you be given certain information in connection with your submission of the attached form related to a patent application or patent. Accordingly, pursuant to the requirements of the Act, please be advised that: (1) the general authority for the collection of this information is 35 U.S.C. 2(b)(2); (2) furnishing of the information solicited is voluntary; and (3) the principal purpose for which the information is used by the U.S. Patent and Trademark Office is to process and/or examine your submission related to a patent application or patent. If you do not furnish the requested information, the U.S. Patent and Trademark Office may not be able to process and/or examine your submission, which may result in termination of proceedings or abandonment of the application or expiration of the patent.

The information provided by you in this form will be subject to the following routine uses:

1. The information on this form will be treated confidentially to the extent allowed under the Freedom of Information Act (5 U.S.C. 552) and the Privacy Act (5 U.S.C. 552a). Records from this system of records may be disclosed to the Department of Justice to determine whether disclosure of these records is required by the Freedom of Information Act.
2. A record from this system of records may be disclosed, as a routine use, in the course of presenting evidence to a court, magistrate, or administrative tribunal, including disclosures to opposing counsel in the course of settlement negotiations.
3. A record in this system of records may be disclosed, as a routine use, to a Member of Congress submitting a request involving an individual, to whom the record pertains, when the individual has requested assistance from the Member with respect to the subject matter of the record.
4. A record in this system of records may be disclosed, as a routine use, to a contractor of the Agency having need for the information in order to perform a contract. Recipients of information shall be required to comply with the requirements of the Privacy Act of 1974, as amended, pursuant to 5 U.S.C. 552a(m).
5. A record related to an International Application filed under the Patent Cooperation Treaty in this system of records may be disclosed, as a routine use, to the International Bureau of the World Intellectual Property Organization, pursuant to the Patent Cooperation Treaty.
6. A record in this system of records may be disclosed, as a routine use, to another federal agency for purposes of National Security review (35 U.S.C. 181) and for review pursuant to the Atomic Energy Act (42 U.S.C. 218(c)).
7. A record from this system of records may be disclosed, as a routine use, to the Administrator, General Services, or his/her designee, during an inspection of records conducted by GSA as part of that agency's responsibility to recommend improvements in records management practices and programs, under authority of 44 U.S.C. 2904 and 2906. Such disclosure shall be made in accordance with the GSA regulations governing inspection of records for this purpose, and any other relevant (*i.e.*, GSA or Commerce) directive. Such disclosure shall not be used to make determinations about individuals.
8. A record from this system of records may be disclosed, as a routine use, to the public after either publication of the application pursuant to 35 U.S.C. 122(b) or issuance of a patent pursuant to 35 U.S.C. 151. Further, a record may be disclosed, subject to the limitations of 37 CFR 1.14, as a routine use, to the public if the record was filed in an application which became abandoned or in which the proceedings were terminated and which application is referenced by either a published application, an application open to public inspection or an issued patent.
9. A record from this system of records may be disclosed, as a routine use, to a Federal, State, or local law enforcement agency, if the USPTO becomes aware of a violation or potential violation of law or regulation.

Interview Survey on IP Offices Concerning Representations of Designs

Name of the Country: European Union

Time and Date of Visit (or Telephone conference):

Visited IP Office:

Name of the Person Representing the IP Office (Please write if possible):

Names of the Visitor and the Firm:

Question 1 Basic principle concerning representations of designs

Question 1-1 In the laws, regulations, examination guidelines, etc., of your country, there are provisions concerning the disclosure of designs. What is the underlying principle behind those provisions that determines the extent of disclosure of designs? In other words, when determining the extent of disclosure of designs, what are the primary goals of your country?

Example answers are listed below. Please give us a detailed answer.

- To facilitate formality examination or substantive examination.
- To facilitate storage of the submitted representations (drawings, photographs, specimens, etc.).
- To reduce the burdens on the users of the design system.
- To facilitate understanding of third parties (those other than design applicants and design holders)
- To facilitate the enforcement of rights.
- To ask for self-responsibility of the applicant who discloses his/her design.

Answer Section 1-1

Publication of designs serves the information to third parties and facilitates the enforcement of the right of the holder.

意匠の公開は、第三者へ情報を提供するとともに、権利行使をしやすくするものである。

Question 1-2 In many cases, designers design industrial products by using 3D CAD and CG software. Does your country allow design applicants to use the 3D CG images created in the stage of product design such as those shown below as design representations to be included in design application documents?

[Article which constitutes the Design] Attachable wash-basin

[International Design Classification] 23-02

[Description of the Article which constitutes the Design] This design will be used mostly by medical staff to wash their hands in medical facilities, etc.

[Description of the Design] Each drawing was created using computer graphics software. The shading applied to the entire surface of the 3D configuration presented in each drawing shows the shape of the curved surface.

[Perspective view]

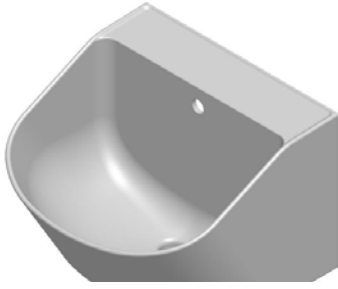

[Top view]

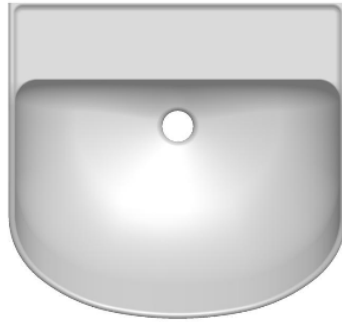

[Front view]

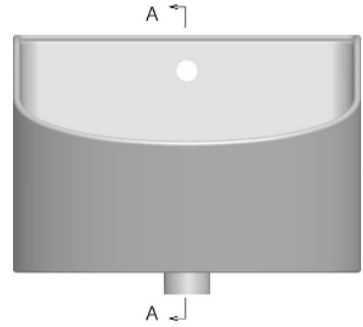

[Right side view]



[Left side view]



[Bottom view]

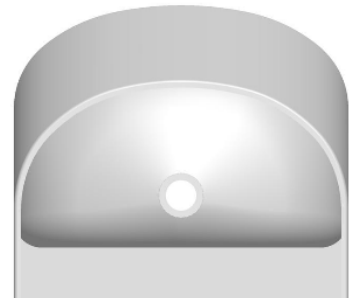

[Rear view]



[A-A sectional view]



[The article in use]



Japan Design Registration No. 1442550

Answer Section 1-2

Yes, the OHIM allows static images created by using CAD and CG software.

With reference to the example:

The Office would accept these images, but only the maximum of 7 views, whilst the arrows and letters appearing in the third view would have to be removed.

OHIM は CAD や CG で作成した静止画像を認めている。

上記の例との関連で、OHIM ではこれらの画像は受理されるが、図の数は最大7までであり、3つめの図にある矢印や文字は削除しなければならない。

Question 2 Representations of designs under the system to protect the design of a part of an article (partial design system)

Question 2-1 This is a question to the IP Office of any country that has either a partial design system or a system to protect the design of a part of an article. If you are representing the IP Office of any country that has neither of these systems, please skip this question and answer Question 2-2.

Two specific examples of representations of partial designs are given below. In the case of Example 1, an applicant seeking protection for a partial design used a different color to distinguish the partial design from the rest of the article. In the case of Example 2, an applicant seeking protection for a partial design used a different line (broken line) to distinguish the partial design from the rest of the article. Does your country allow such representations of partial designs? Please tell us whether and why each of the following two methods shown in the following examples is permitted or not?

(Example 1) A case where an applicant seeking protection for a partial design used a different color to distinguish the partial design from the rest of the article

[Article which constitutes the Design] Passenger car

[International Design Classification] 12-08

[Description of the Design] The applicant is seeking registration of the partial design of the part other than the pink part shown in the drawings. The bottom view is omitted because this is a heavy article. The shading applied to the entire surface of the 3D configuration presented in each drawing shows the shape of the curved surface.

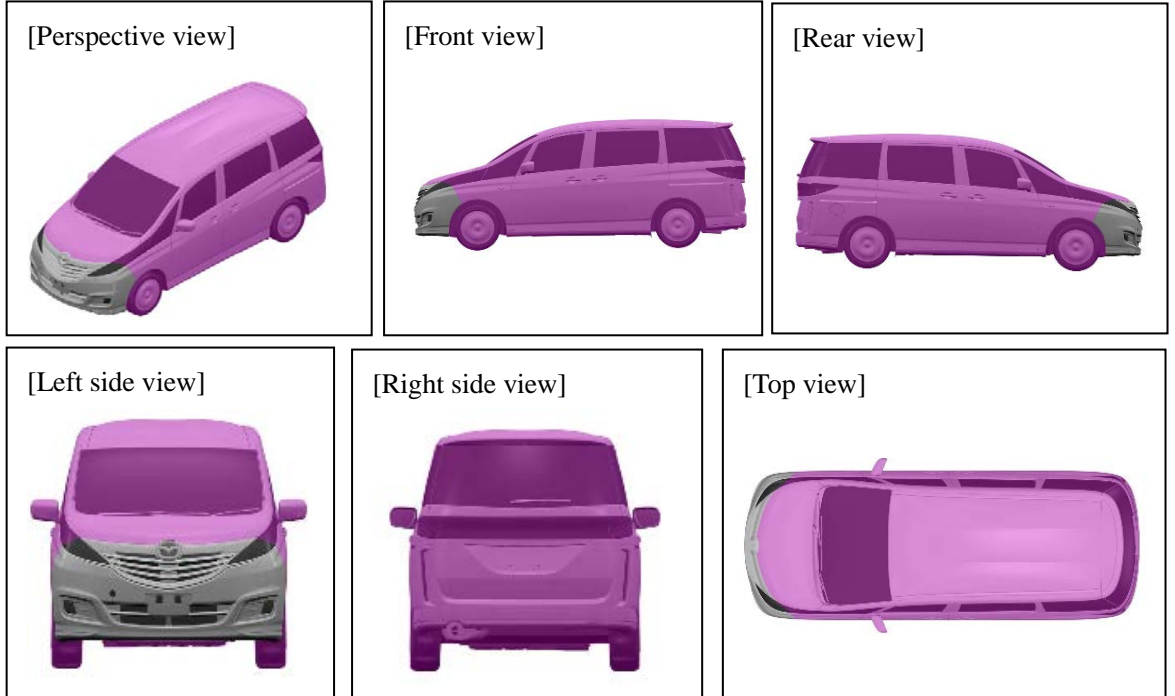

Japan Design Registration No. 1444223

(Example 2) A case where an applicant seeking protection for a partial design used a different line to distinguish the partial design from the rest of the article

[Article which constitutes the Design] Packaging container

[International Design Classification] 09-01、09-02、09-03、09-04、09-05、28-01

[Description of the Design] The part drawn by a solid line shows the part for which the applicant is seeking registration as a partial design.

The rear view is symmetrical to the front view

The bottom view is the same as the top view.

The enlarged rear view of the cap is symmetrical to the enlarged front view.

The enlarged bottom view of the cap is symmetrical to the enlarged top view.

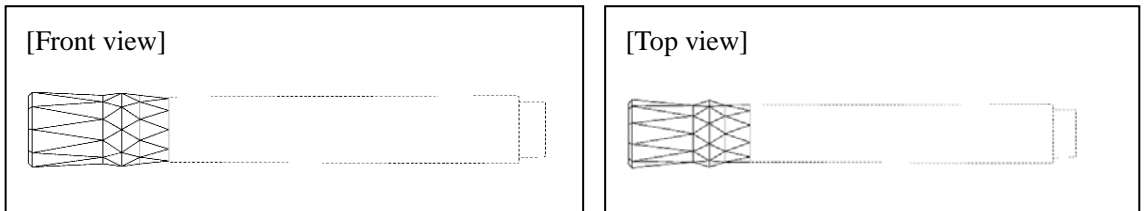

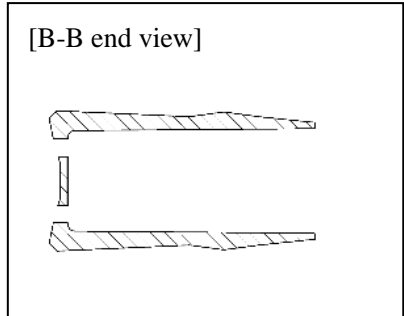
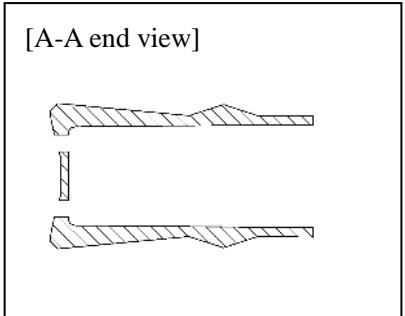
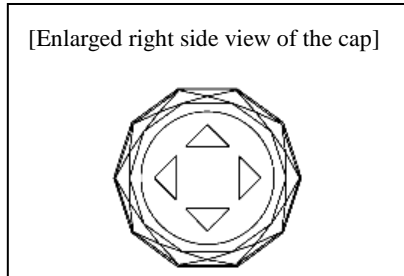
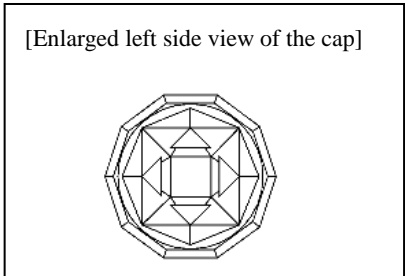
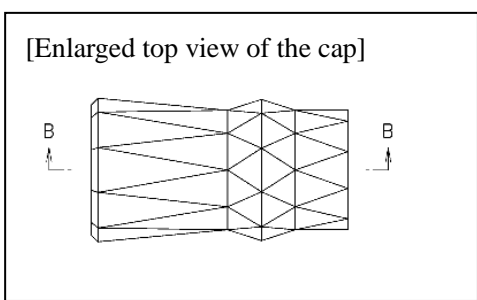
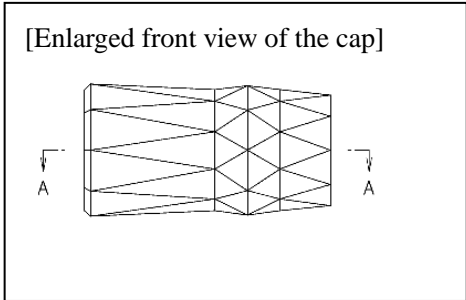
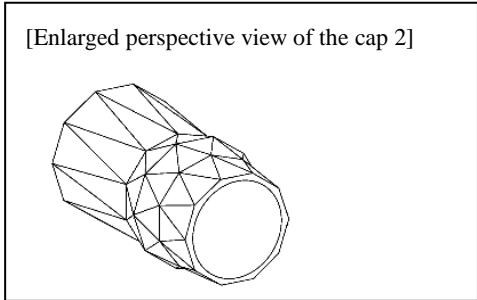
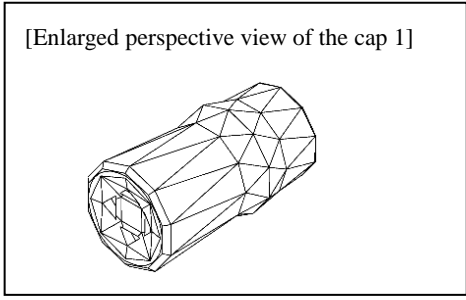
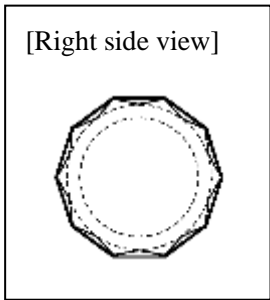
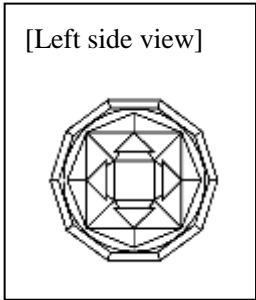

Answer Section 2-1

The OHIM allows the registration of a design which is the appearance of a part of a product in accordance with the regulations.

The OHIM accepts visual disclaimers as long as it is clear in the representation of the design for which part protection is sought and which part shall not be protected. Acceptable visual disclaimers include but are not limited to the use of colouring or dotted lines as in the two examples.

OHIMは規則に基づき、製品の一部の外観である意匠の登録を認めている。

また、図示によるディスクレーマーは、保護を求める部分と保護しない部分について、意匠の表現が明瞭である限り、認められる。許容される図示のディスクレーマーには、上記の2例のように、色彩や破線の使用があるが、これに限定されない。

Question 2-2 This is a question to the IP Office of any country that has neither a partial design system nor a system to protect the design of a part of an article. If you are representing the IP Office of any country that has either of these systems, please skip this question and answer Question 3.

Do the users of the design system of your country request protection for the partial designs of articles? For example, is there a need for the establishment of a partial design system, which is an effective countermeasure against infringers of partial designs who copy only a unique and innovative part of an article without copying the design of the article as a whole?

Answer Section 2-2

Not applicable

該当なし

Question 3 The policy of conducting to find designs

Please answer this question regardless of whether your country has adopted a system that conducts only formality examination before registration, a system that conducts both formality examination and substantive examination before registration, or a system that conducts formality examination on all applications and conducts substantive examination only on certain applications before registration.

Question 3-1 In the course of formality examination on the design claimed in an application, to what extent do you conduct to find the design? Example answers are listed below. Please give us a detailed answer.

- We examine whether an application satisfies the prescribed formality requirements such as the number, sizes, etc., of the submitted drawings or photographs but do not examine the design in further detail.
- In addition to whether a design satisfies the formality requirements, we conduct to find out whether the design is disclosed in accordance with the relevant regulations by taking into consideration the article that embodies the design and checking the drawings, photographs, etc., submitted by the applicant.
- If we conduct to find design and determine that the design fails to satisfy the substantive requirements for design registration (e.g., the case where the design clearly lacks novelty), we conduct substantive examination as well

Answer Section 3- 1

In addition to an examination on formalities regarding the representation of the design and an examination whether the design is contrary to public policy or morality, we examine whether all views relate to the same design.

意匠の表現に関する方式および当該意匠が公序良俗に反しないかどうかの審査に加え、すべての図が同一の意匠に関するものかどうかを審査する。

Question 3-2 Who conducts the formality examination mentioned in Question 3-1? Is it conducted by a formality examiner, Office staff member, or any other staff member (including a substantive examiner)? Please specify.

Answer Section 3-2

A designs examiner carries out the examination of a design application, from reception to publication.

1名の意匠審査官が、出願の受理から公開まで審査を担当する。

Question 3-3 Do you have a system to invalidate a registered design right on the grounds that the design is unclear for such reasons as the design right having an unidentifiable scope? Example answers are listed below. Please give us a detailed answer.

- System to file a request with the IP Office for commencement of examination
- System to file a request with the IP Office for an invalidation trial

Answer Section 3-3

A request for invalidation may be filed with the Office pursuant to Article 25(1)(a) Community Design Regulation (CDR), by which a Community Design may be declared invalid if the design does not correspond to the definition under Article 3 (a) CDR. This would be the case where the views of the Community design display inconsistent products, or where the graphical representation consists of mere representations of nature (landscapes, fruits, animals etc.).

意匠理事会規則（CDR）第 25 条(1)(a)の規定（意匠が第 3 条(a)による定義に適合していない共同体意匠は、無効を宣言できる）に従い、OHIM に無効の請求を行うことができる。これには、共同体意匠の図の表示が製品と矛盾する場合や、グラフィック表示が単に自然の表現（風景、果物、動物など）のみで構成されている場合などがある。

Question 3-4 Is there any judicial precedent where the clarity of a design representation was at issue? If yes, please summarize the judgment and tell us the grounds on which the court found the design representation to be unclear.

Answer Section 3-4

In Case T-68/10 of 14 June 2011 the General Court of the EU dealt with the requirement of the design representation. It made reference to paragraph 11.4 of the examination guidelines for Community designs, adopted by decision EX-03-9 of the President of OHIM, of 9 December 2003, headed ‘Format of the Representation of the Design’, which provides that the representation of a design should be limited to the features for which protection is sought. However, the representations may compromise other elements that help to identify the features of a design for which protection is sought. In an application for registration of a Community design, *inter alia*, an identifier consisting of dotted lines in a view to indicate the elements for which no protection is sought is allowed. Therefore, dotted lines identify elements which are not part of the view in which they are used. According to the above guidelines, the General Court found that the design representation was clear in that the parts of the design which were identified by dotted lines did not form part of the elements that were protected by the contested Community design.

事件 T-68/10（2011 年 6 月 14 日）は、EU 第一審裁判所が意匠表現の要件を扱ったもので、2003 年 12 月 9 日の OHIM 長官による決定 EX-03-9 によって採択された共同体意匠審査ガイドラインの第 11.4 項「意匠表現の形式」に言及しており、そこでは、意匠の表現は、保護を求めめる特徴に限定すべきであると規定している。ただし表現には、保護を求めめる意匠

の特徴を識別するのに役立つその他の要素を含むこともできる。特に共同体意匠の登録出願においては、保護を求めない要素を示す破線からなる識別方法は認められる。したがって、破線はその意匠の一部でない要素を識別するものである。第一審裁判所は、前記ガイドラインに基づき、意匠において破線で識別された部分が、当該共同体意匠によって保護される要素の一部を構成しないことが、意匠表現から明らかであると判断した。

Question 4 Principle concerning amendments

Question 4-1 Is it permitted to amend a design application? If yes, what restrictions are imposed on an amendment in terms of time schedule and content? Please tell us any restrictions imposed on an amendment in practice other than those specified in the laws, regulations, examination guidelines, etc., that we should know about. Furthermore, is it permitted to make a voluntary amendment?

Answer Section 4-1

It is only permitted to amend the representation of the design in a design application in connection with a deficiency at the request of the examiner within a specific time limit. If the deficiency means that no filing date is given, the date of reception of the amended and acceptable views will determine the filing date. If the deficiency does not affect the filing date, the amended views must be based on the original views, for example by removing symbols and text from the original view.

審査官の請求があった場合、指定された期限内に、出願における不備との関連に限り、意匠の表現を補正することが認められる。不備によって出願日が決められない場合は、補正された図が受理された日が出願日になる。不備が出願日に影響しない場合、図の補正は、例えば、最初の図からの記号や文字の削除など、最初の図に基づいたものでなければならない。

Question 4-2 What may be submitted to make an amendment? Please tell us what may be submitted in practice other than those specified in the laws, regulations, examination guidelines, etc.

Answer Section 4-2

No amendments to the representation of the design, other than those specified in the regulations and examination guidelines can be accepted.

意匠の表現に対する補正は、規則および審査ガイドラインで規定されているもの以外は認められない。

Question 4-3 If the IP Office refuses to accept any amendment made in response to an amendment order or made voluntarily, what action would the IP Office take? Is there a possibility that the IP Office dismisses the design application? Or, if only a minor defect is involved, would the IP Office accept amendment and register the application which was amended?

Answer Section 4-3

If the amendment to the design does not correspond to the request from the examiner, the design application is rejected.

If an amendment to the design (even a minor one) is requested by the applicant, the amendment is denied but the further examination and registration process remain unaffected.

意匠の補正が審査官の請求に対応していない場合、意匠出願は拒絶される。

意匠の補正（些細なものも含む）を出願人が求め、認められない場合でも、その後の審査や登録のプロセスには影響しない。

Question 4-4 Even though a design application is satisfied the formality requirements, are there any cases where the IP Office sends the applicant a instruction for an amendment related to a representation of the design in order to facilitate to conduct finding the design or to make the representation of the design more accurate? Please tell us what is stated in such a request in detail.

Answer Section 4-4

If an application is received by fax, the applicant will be informed that the original representation of the design will be used, provided it is received (e.g. by post) within one month from the fax.

The filing date remains unaffected.

出願をファックスで受理した場合は、1 カ月以内に意匠のオリジナルが（郵送などで）送

付されれば、オリジナルを使用することが出願人に通知される。出願日には影響しない。

Question 4-5 In the case mentioned in Question 4-4, if the IP Office sends an instruction to an applicant, is the applicant required to make an amendment strictly in accordance with the instruction? Or, is the applicant permitted to make an amendment in the way he/she wishes to a certain extent? Please explain in detail.

Answer Section 4-5

The representation of the design received by post, courier or personal delivery must correspond exactly to the representation of the design as received by fax.

郵便、宅配便、直接送達などで提出される意匠表現は、ファックスで提出した意匠表現と厳密に一致しなければならない。

Question 4-6 Is it permitted for a design applicant to divide the application and file a divisional application as a new design application? If we yes, what restrictions are imposed on the filing of a divisional application in terms of time schedule and content? Please tell us any restrictions imposed in practice other than those specified in the laws, regulations, examination guidelines, etc., that we should know about. For instance, is it permitted to divide a design application for a whole article and file a divisional design application for a new part or component?

Answer Section 4-6

A division of a design is only possible at the request of the examiner in connection with a deficiency. In particular the deficiency is that the representation shows more than one design.

After filing, part of the design cannot be singled out and included as a separate design in the same application at the request of the applicant.

意匠の分割は、不備に関して審査官の請求があった場合にのみ可能である。不備として特に、2つ以上の意匠が表現されている場合が挙げられる。

出願提出後に、出願人の請求によって、意匠の一部を抜き出し、別の意匠として同一の出願に含めることはできない。

Question 4-7 Before the according of the application filing date, is it necessary for the applicant to satisfy the requirements for representation of a design and a design should be found? Or, may the application filing date be accorded without finding a design as

long as the formality requirements are satisfied (e.g., the number and size of drawings or photographs)?

Answer Section 4-7

The conditions for the representation of a design in order to accord a filing date are neutral background and a sufficient quality. If these conditions are met, a filing date can already be accorded before other formalities are addressed.

出願日が認定されるための意匠の表現の条件は、無地の背景と十分な質である。これらの条件が満たされれば、その他の方式を審査する前であっても、出願日は認定できる。

Question 4-8 In the case specified in Question 4-7, after an applicant makes an amendment in response to an order for amendment that the IP Office issued on the grounds that the requirements for according the application filing date were not satisfied, if said requirements are satisfied as a result of the amendment, which date does the IP Office accord as the application filing date, either the first application filing date or the date on which the amendment was submitted?

Answer Section 4-8

In this case, the date on which the acceptable amendment was received determines the filing date.

この場合、要件を満たした補正が受理された日が、出願日になる。

Question 4-9 In the case of an IP Office that conducts to find a design as a prerequisite for according the application filing date, please answer this question. In the case of any other IP Office, please skip this question and answer Question 5.

In the case mentioned in Question 4-8, if an amendment submitted to the IP Office changes the gist of the design, how would the amendment be treated? Would it be dismissed? Or, would it be deemed as a new application filed on the date on which the written answer to the order for amendment is submitted? Please explain in detail.

Answer Section 4-9

If the amendment mentioned in Question 4-8 changes the gist of the design, it would still be accepted as it determines the filing date. Therefore, there is no requirement that the amended

representation should correspond exactly to the original representation.

質問 4-8 の補正が、意匠の要旨を変更するものである場合でも、受理され、その日が出願日となる。したがって、補正した表現が、最初の表現と厳密に一致しなければならないという要件はない。

Question 5 Principle of unity

Question 5-1 Please tell us the requirements for representations of designs in order for multiple designs to be regarded as a single design.

Please give us a detailed answer. For example, is it the case that the designs of articles that are used in a physically separated manner may be regarded as a single design as long as those designs are regarded as a set in terms of design (e.g., a set of stackable pans), that a set of similar designs may be regarded as a single design as long as those designs are similar to each other in terms of configuration¹, that the designs represented in a drawing in a physically separated manner may be regarded as a single design as long as those articles are used simultaneously (e.g., a pen and its cap), or that the designs of different articles may be regarded as a single design as long as they are used simultaneously (e.g., a stationary article and its base)? Which requirements, either formality requirements (formality examination) or substantive requirements (substantive examination), must be met in order to recognize multiple designs as a single design? If multiple designs are not regarded as a single design, how would the IP Office treat them?

(Example) In Japan, a design application would be dismissed (i) if the applicant states two or more classifications of articles in the section entitled "Article which constitutes the design" of an application, (ii) if the applicant presents drawings of two or more articles, or (3) in the case of an application for the design of a part of an article, if the application covers two or more physically separated parts. If an application is dismissed for any of the aforementioned reasons, the applicant may file a divisional application (substantive requirements).

Answer Section 5-1

A set of products can be considered as constituting one product and registered as a single design.

A requirement is that the product are likely to be used and or sold together.

A requirement for the representation is that at least one view shows the whole set, whereas additional view can show only part of the set.

The parts may belong to different classes, for example a phone with charger/base station.

A complex product may be shown as separate parts, as long as one view shows the complete and assembled product.

¹ "Configuration" means here that the shape, patterns or colors, or any combination thereof, of an article. The same shall apply hereinafter.

If the products which are filed as one design cannot be regarded as a set, the OHIM will request the applicant to divide the design, failing which the application will be refused.

セットものは1つの製品を構成すると見なされ、単一の意匠として登録される。その製品が一緒に使用または販売されると考えられることが必要である。表現に関する要件としては、少なくとも1つの図でセット全体を示し、その他の図でセットの部分のみを示す必要がある。例えば、充電器／基地局を備えた電話のように、各部分が異なる分類に属している場合もある。複雑な製品については、1つの図で組み立てられた完全な形の製品が示されていれば、各部分を別々に示すことができる。一意匠として出願した複数の製品がセットと見なされない場合、OHIMは出願人に対して、意匠を分割するよう要求し、これを行わなければ、出願は拒絶される。

Question 5-2 This is a question to the IP Office of any country that protects images. If your country does not protect images, please skip this question and answer Question 6.

Please tell us the provisions concerning representations of drawings that are required to be made in order to have multiple images regarded as a single design. Which requirements, either formality requirements (formality examination) or substantive requirements (substantive examination), must be met in order to have multiple images regarded as a single design? If multiple images are not regarded as a single design, how would the IP Office treat them?

(Example) In Japan, multiple images may be regarded as a single design covering multiple images in the case where the image before a change and the image after the change are used in relation to the same function of an article as long as those two images are considered to be related to each other in terms of configuration. If multiple images are not regarded as a single design, the application would be dismissed on the grounds that multiple images should be regarded as multiple designs (substantive requirements).

Answer Section 5-2

Multiple images as such (not representing a three dimensional object) can only be accepted as one design if they relate to a design that is visible on a display screen such as an (animated) icon or a graphical user interface.

The indication of product should correspond accordingly.

The images must have common features.

複数の画像（立体を表現していない）は、ディスプレイ画面に表示される（動画）アイコンやGUIのように、1つの意匠に関するものである場合に限り、一意匠と認めることができる。

製品の表記は相応のものにすべきである。

各画像には、共通の特徴がなければならない。

Question 6 Scope of design protection

Question 6-1 Based on what definitions or ideas concerning the similarity of the configurations of designs do you determine the scope of design protection? Please give us any judicial precedent where the court presented its interpretation about how to interpret the scope of design protection from the perspective of configuration similarity, for example, whether the scope of design protection only covers almost identical designs or covers designs of different degrees of similarity (variations).

Answer Section 6-1

The scope of protection of a Community design includes "any design which does not produce a different overall impression" on the informed user. The two designs must be compared globally. This does not mean that the same weight should be given to all the features of the compared designs. The relative weight to give to the features of the compared designs may therefore depend on how the product in which the design is incorporated is used. The role played by some features may be less important on account of their visibility when the product is in use (judgment of 22/06/2010, T-153/08, 'Communications equipment', para. 64-66 and 72). Moreover, in the assessment of the overall impression, a minor importance is given to features that are totally banal and common to the type of product in question, while features which are arbitrary or different from the norm will play a greater role (judgment of 18/03/2010, T-9/07, 'Representation of a circular promotional item', para. 77) . Similarities affecting features for which the designer enjoyed a limited degree of freedom will have only minor importance in the overall impression made by those designs on the informed user (judgment of 18/03/2010, T-9/07, 'Representation of a circular promotional item', para. 72). Fundamental characteristics of a design which are deemed to be remembered by the informed user play a greater role in the assessment of the overall impression (judgment of 16 December 2010, T-513/09, para. 22)

共同体意匠の保護範囲には、情報に通じた使用者に対して「異なる全体的印象を与えない意匠」が含まれる。2つの意匠を全体的に比較する必要があるが、これは、比較する意匠のすべての特徴を同じ比重で扱うことを意味しない。各特徴の相対的な比重は、意匠が含まれる製品がどのように使用されるかによって異なる。製品を使用する際の視認度によって、重要度が低い特徴もあると考えられる (judgment of 22/06/2010, T-153/08, '通信機器', para. 64-66 and 72)。さらに、全体的印象の評価においては、対象となる種類の製品にとって、ありふれた一般的な特徴は重要性が低いのに対し、通常とは異なる特徴は、より大きな役割を果たす (judgment of 18/03/2010, T-9/07, '販促チラシの項目の表現', para. 77)。意匠創作者の自由度が制限される、特徴に影響する類似性は、情報に通じた使用者に与える全体的印象において、わずかな比重しかない (judgment of 18/03/2010, T-9/07, '販促チラシの項目の表現', para. 72)。また、情報に通じた使用者に記憶されると見なされる、意匠の基本的な特徴は、全体的印象の評価において、より比重が大きくなる (judgment of 16 December 2010, T-513/09, para. 22)。

Question 6-2 Please explain in detail how the scope of design protection is affected by the identity or similarity of articles or by the identity or similarity of the functions and use of articles. Please give us any judicial precedent where the court presented its interpretation as to how the scope of design protection is affected by these factors.

Answer Section 6-2

In the comparison of designs the relative weight to give to the features of the compared designs may depend on how the product in which the design is incorporated is used (judgment of 22/06/2010, T-153/08, ‘Communications equipment’, para. 64-66). The overall impression must necessarily be determined also in the light of the manner in which the product at issue is used. The underlying principle is that the attention of the informed user focuses on those features which are essential or characteristic of the product concerned. To this effect the visibility of the features concerned is also of importance, thus having a greater influence on the assessment of the overall impression (judgment of 22/06/2010, T-153/08, ‘Communications equipment’, para. 72-74).

意匠の比較において、各特徴におかれる相対的な比重は、意匠が含まれる製品がどのように使用されるかに応じて異なる (judgment of 22/06/2010, T-153/08, ‘通信機器’, para. 64-66)。また、全体的印象は必然的に、対象の製品が使用される方法を踏まえて判断される。基本原則は、情報に通じた使用者の注意は、その製品の本質的な特徴や特有の部分に注がれるということである。この意味において、そうした特徴の視認性も重要で、全体的印象の評価に大きな影響を及ぼす (judgment of 22/06/2010, T-153/08, ‘通信機器’, para. 72-74)。

Question 6-3 Please explain in detail how the scope of design protection is affected by the parts of an article that are not represented in drawings or photographs.

Answer Section 6-3

Parts of a design which are not represented by means of drawings or photographs fall outside of the scope of protection of a registered design. In fact what is protected is the appearance of a product and not the product itself.

図面や写真で表現されていない部分は、登録意匠による保護の範囲に含まれない。実際、保護されるのは製品の外観であって、製品そのものではない。

Question 6-4 In the case of a design right for an article which partially changes to perform its functions, does the scope for design protection cover the configurations observed in the course of change? Or, does the scope of design protection cover only the configuration before a change and the configuration after the change?

The following is a specific example where a part of an article (toy) that has a three-dimensional configuration changes its configuration to perform its functions.

[Front view]



[Rear view]

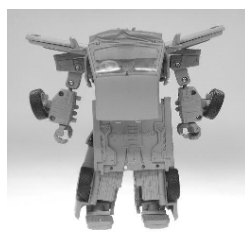

[Left side view]



[Right side view]

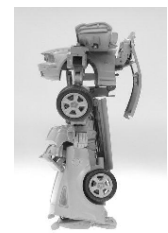

[Top view]



[Bottom view]



[Perspective view of the changing configuration]



[Front perspective view after the change]



[Rear perspective view after the change]



Answer Section 6-4

The design protects the appearance of the whole or a part of a product resulting from its features. The representation can be photos, computer drawings or drawings by hand. Maximum 7 different views per design are admitted. All views should show the same product in the same colour. The alternative positions of a moveable or removable part of a design can be shown in separate views. The Office shall take the views in the consecutive order in which the views are numbered by the applicant. The views shall relate to the same design, that is to the appearance of one and the same product or of its parts.

意匠は、製品の特徴によって、その製品の全体または一部の外観を保護するものである。表現は、写真、コンピュータ描画、手書きの図面などがある。1つの意匠あたり、最大7つの図が認められる。すべての図は、同一の製品を同じ色で示さなければならない。可動または着脱可能な部分の他の位置は、別の図で示すことができる。OHIMは出願人が番号を振った順序通りに図を審査する。すべての図は同じ意匠に関するもの、つまり、同一の製品またはその部分に関するものでなければならない。

Question 6-5 This question is about the scope of design protection in the case of a set of articles or a certain set of articles. Does the design protection only cover a set of articles or a certain set articles? Or, does the design protection also cover each article that comprises a set?

If simultaneously used multiple articles are coordinated as a whole, the designs of those articles may be regarded as a single design. Such a design may be regarded as a "design for a set of articles." The term "a design for a certain set of articles" is conceptually the same as "a design for a set of articles." The term "a design for a certain set of articles" refers to a design used for any of the prescribed types of set.

Answer Section 6-5

By definition a set of articles is a group of products of the same kind which are generally regarded as belonging together and are so used. There is no mechanical connection among the articles of a “set of article”. A set of articles can be a product in itself. A set of articles can be represented in a single design application if the articles concerned are linked by aesthetic and functional complementarity and, under normal circumstances, are sold together as one product, like a chess board and its related pieces or sets of knives, forks and spoons. It must be clear from the representation that protection is sought for a design resulting from the combination of the articles making up the set. To protect not only the set of articles as a product but also each articles forming the set, the applicant can file a multiple application combining the separate designs for each article in question.

定義では、セットとは、一般に同類と見なされ、そのように使用される、同じ種類の製品のグループである。セットの物品どうしには機械的な結合はなく、一つ一つがそれ自体で製品である。セットの物品は、美的／機能的な補完によって結びつけられ、単一の意匠出願の中で表現することができ、通常の状態では、一つの製品として販売される。例えば、チェスのボードと駒や、ナイフ、フォーク、スプーンのセットなどがある。セットを構成する物品の組合せによる意匠に対して保護を求めるものであることを、表現によって明瞭にする必要がある。セットだけでなく、セットを構成する各物品をも保護するには、各物品に関する意匠を組み合わせた、多意匠一出願を提出することができる。

Question 6-6 This is a question about the restrictions on the exercise of design rights that are related to each other in conflict of which both right holders and both filing dates are deferent.

Design rights are considered to be related to each other in conflict in the following three cases:

- (i) a design right to protect the design of a whole article and a design right to protect the design of a component of the article (the component can be regarded as an independent article). Filing date of the design right of a component of the article is earlier than filing date of the design right of a whole article. Both rights are owned by

- deferent persons;
- (ii) a design right to protect the design of a whole article and a design right to protect the design of a part of the article (a part means a portion of the article and cannot be separated as a component). Filing date of the design right of a part of the article is earlier than filing date of the design right of a whole article. Both rights are owned by deferent persons; and
 - (iii) a design right to protect the design of a set of articles or a certain set of articles and a design right to protect the design of any article that comprises a set. Filing date of the design right of any article that comprises a set is earlier than filing date of the design right of a set of articles or a certain set of articles. Both rights are owned by deferent persons.

For example, in Case (i) above, if the holder of a design right to protect the design of a whole article works the design or exercises the design right, is it sometimes necessary for him/her to obtain a license from the holder of a design right to protect the design of a component? How about the situations in Case (ii) and Case (iii) described above in terms of the restrictions on the exercise of design rights?

Answer Section 6-6

The scope of protection of a design extends to cover any design which does not produce on the informed user a different overall impression. The need to ask for a license cannot depart from the rule on the scope of protection in order to check whether the right of ownership meets with any restrictions.

意匠の保護の範囲は、情報に通じた使用者に対して異なる全体的印象を与えない意匠に及ぶ。ライセンスを求める必要性があっても、所有権が何らかの制限を受けているかを確認するための、保護の範囲に関する規則から逸脱してはならない。

Question 6-7 This is a question to the IP Office of any country that protects multiple images as a single design.

If your country does not protect multiple images as a single design, please skip this question and answer Question 7.

In the case of two related design rights, i.e., a design right to protect the designs of multiple images and a design right to protect the design of any of those images, are in conflict. Filing date of the design right of any of those images is earlier than filing date of the designs right of multiple images. Both rights are owned by deferent persons. In this case, are any restrictions imposed on the exercise of those design rights?

Answer Section 6-7

The Community design system admits multiple applications, provided that the products to which the design is applied to belong to the same Locarno class, that is to pertain to the same type of goods. Any design may be represented in 7 different views. In a multiple application the maximum number of views will be 7 per design, multiplied by the number of designs. If the subsequent design falls under the scope of protection of the earlier one, the right of the previous owner will be restricted accordingly.

共同体意匠制度では多意匠一出願を認めているが、ただし、意匠に関する製品が同一のロカルノ分類に属していること、すなわち、同じ種類の物品であることを条件とする。意匠は7つの図で表現することができる。多意匠一出願では、7×意匠の数が図の上限数になる。後の意匠が先の意匠の保護の範囲に含まれる場合、先の意匠の所有者の権利は相応に制限される。

Question 6-8 This is a question to the IP Office of any country that protects multiple images as a single design and conducts substantive examination. If your country does not protect multiple images as a single design and does not conduct substantive examination, please skip this question and answer Question 7.

In case of a application seeking for a protection of a design of multiple images When filing date of a application seeking for a protection of design of any those images is earlier than filing date of a application seeking for a protection of a design of multiple images, and both applicants are different, what measures do you take when determining whether such a design has novelty and is not easily creatable by any person skilled in the art?

Answer Section 6-8

OHIM does not carry out substantive examination of design applications except to verify that the applications are for a design and that the design is not contrary to public policy or morality.

OHIM では、出願が意匠に関するものか、および公序良俗に反しないかを確認する以外は、実体審査は行っていない。

Question 7 Disclosure by drawings included in application documents and publication by gazettes

Question 7-1 Are there any cases where a drawing or photograph included in application documents is edited (e.g., altered in size or ratio) when the design is publicized in a design gazette (including an electronic gazette)? If editing is conducted, please tell us the reasons and standards for editing.

Answer Section 7-1

Publication is done only electronically and can be found in the Community Designs Bulletin or in the Online Database, both available on the website of the Office. For publication purposes, the views included in the application may be enlarged or reduced. It is also possible by clicking on the view to see the original size and jpeg format if filed electronically or a high resolution jpeg scan if filed on paper.

公開は電子媒体のみで行い、共同体意匠公報またはオンラインデータベース（いずれも OHIM のサイトからアクセスできる）で見ることができる。公開目的で、出願に含まれる図を拡大または縮小することもある。図をクリックして、元のサイズの JPEG 画像（電子出願の場合）または高解像度の JPEG スキャン画像（紙出願の場合）を見ることが出来る。

Question 7-2 If a design application is filed by an electronic medium, do you store printed-out hardcopies of the representations of the design as the original documents in addition to the submitted electronic images of those representations? If yes, why?

Answer Section 7-2

The OHIM does not store printed-out hard copies of electronically filed representations of the design.

OHIM では、電子出願された意匠のプリントアウトしたハードコピーは保管しない。

Question 7-3 Does the public have access to the documents (including electronic data) prepared in the course of design prosecution starting from the filing of a design application to the registration of the design? If yes, please tell us the inspection fee and conditions (to what extent is inspection permitted? Are there any documents that are not available for inspection?).

Answer Section 7-3

After the publication of the design in the Community Designs Bulletin, the files relating to the application and the resulting design may be inspected on request by the public.

Prior to publication, files may be inspected if the applicant consents to the inspection or if there is a legitimate interest in inspecting the file without the consent of the applicant.

共同体意匠公報での意匠の公開後は、出願および意匠に関するファイルを、公衆が請求して閲覧できる。

公開前は、出願人が閲覧に同意した場合、または出願人の同意がなくても、ファイルを閲覧することに正当な利益がある場合は、閲覧できる。

Conditions for the inspection of files of registered designs by third parties:

登録意匠のファイルを第三者が閲覧する条件は以下の通りである。

- **the file documents for which inspection is sought do not concern the exclusion of or objection to a member of OHIM taking part in proceedings**
閲覧を求めるファイル書類が、法的手続に参加している OHIM メンバーに対する除斥や異議に関するものでないこと
- **the file documents for which inspection is sought do not relate to documents used for the preparation of decisions and opinions**
閲覧を求めるファイル書類が、決定や意見の作成に使用される書類に関連していないこと
- **the file documents for which inspection is sought are not indicated as being confidential. Should the file documents be indicated as confidential, the applicant for inspection must establish that he or she has an overriding legitimate interest in obtaining inspection**
閲覧を求めるファイル書類が、秘密書類であると示されたものでないこと。秘密書類であると示されている場合、閲覧の申請者は、閲覧することに優先すべき正当な利益があることを証明しなければならない。
- **the RCD is not awaiting deferred publication. Should the publication of the RCD be deferred, the applicant for inspection may nevertheless obtain inspection where he or she brings forward evidence that:**
共同体登録意匠 (RCD) は、公開が延期されていても閲覧できないわけではない。RCD の公開が延期される場合でも、閲覧申請者が以下の証拠を提示すれば閲覧が可能にな

る。

- **the RCD applicant has consented to the inspection**

RCD 出願人が閲覧に同意した。

- **the RCD applicant has stated that after the design has been registered, he or she will not invoke the rights under it against the person requesting the inspection.**

RCD 出願人が、当該意匠の登録後、閲覧を求める者に対して権利を行使しないと表明した。

A request for inspection should be made in writing to the Office.

The relevant fees are listed below:

閲覧の請求は、OHIM へ書面で行う。

該当する手数料は以下の通りである。

- **certified copies or extracts of the RCD application or registration: EUR 30**

RCD 出願または登録の認証謄本／抄本：30 ユーロ

- **uncertified copies or extracts of the RCD application or registration: EUR 10**

RCD 出願または登録の無認証謄本／抄本：10 ユーロ

- **certified copies of file documents: EUR 30, additional fee per page exceeding 10: EUR 1**

ファイル書類の認証謄本：30 ユーロ、10 ページを超えた場合の1ページごとの追加手数料：1 ユーロ

- **uncertified copies of file documents: EUR 10, additional fee per page exceeding 10: EUR 1**

ファイル書類の無認証謄本：10 ユーロ、10 ページを超えた場合の1ページごとの追加手数料：1 ユーロ

- **communication of information in a file: EUR 10, additional fee per page exceeding 10: EUR 1**

ファイルによる情報伝送：10 ユーロ、10 ページを超えた場合の1ページごとの追加手数料：1 ユーロ

Question 8 Do you receive any opinions from users of the design system such as a request for a revision of the design system in order to change the way of representing a design in a design application under the relevant laws, regulations, and examination guidelines of your country and to remedy the current situation where the way of representing a design differs from one country to another? If yes, please describe those opinions in detail.

Answer Section 8

The main issue which users face is that we accept a maximum of 7 views per design whereas some other countries allow a bigger number. This becomes a problem when claiming priority, both when the OHIM is used for the first filing and if the OHIM is used for a subsequent filing.

ユーザーが直面している最大の課題は、OHIMでは1件の意匠で認められる図は最大7つであるのに対し、一部の国々ではこれより多くの図が認められることである。このことが問題になるのは、優先権主張において、OHIMを第一国出願で利用する場合と、OHIMを後の出願で利用する場合である。

Question 9 In recent years, has the number of design applications been on the rise or on the decline? What do you think has caused such increase or decrease?

Answer Section 9

The number of designs filed directly with OHIM has risen from the first year 2003 up to 2007. The years 2008 and 2009 showed a total drop of around 10%. Since then the numbers are on the rise again although not as sharply as in the first years.

Obvious reasons are the economic crisis and joining the Hague Agreement in 2008.

OHIMへの直接の出願は、当初2003年から2007年までは増加したが、2008年と2009年は、全体で約10%減少した。その後、再び増加に転じているが、当初のような急激な伸びはない。

明白な理由として、2008年の経済危機とヘーグ協定加盟がある。

Question 10 If your country has signed the Hague agreement, please answer this question. Did the number of design applications increase or decrease in your country before and after the signing of the Hague agreement?

Answer Section 10

As described in answer 9 the number of direct filings dropped for the first time in 2008, but since this drop coincided with the start of the economic crisis it is difficult to say to what extent the signing of the Hague agreement caused this effect.

When adding the number of international registrations at OHIM to the number of direct filings, the total number of received designs only dropped by around 2% in 2009 and shows a significant rise from 2010 albeit not matching the rise of the early years.

質問 9 で述べたように、直接出願の件数が 2008 年に入って初めて減少したが、これは経済危機が始まった時期とも重なるので、ヘーグ協定調印の影響がどの程度であったかを言うのは難しい。

OHIM への国際出願の件数を直接出願に加えた合計では、2009 年では 2%程度の減少にとどまり、2010 年からは、最初の数年ほどではないが、かなりの増加が見られる。

Question 11 If your country has signed the Hague agreement, please skip this question and answer Question 12.

This is a question to the IP Office of any country that is planning to sign the Hague agreement. What are your purposes for signing the Hague agreement? Please describe your purposes in detail.

Answer Section 11

Not applicable

該当なし

Question 12 Please answer this question if your country has signed the Hague agreement or is planning to do so. In order to sign the Hague agreement, did you have to make any alterations or adjustments to your country's system? Or, is your country planning to alter or adjust your country's system in the future?

Answer Section 12

In connection with the signing of the Hague agreement we haven't made any alterations to our systems nor are any foreseen.

ヘーグ協定調印との関連では、何の制度変更もしておらず、する予定もない。

[Request for information]

- 13** If your country has adopted a multiple design application system, please send us information on how an application and drawings should be prepared in order to file a multiple design application. We would appreciate if you could send us a sample application and a sample drawing that are available for disclosure (those with all the sections filled in with information as a sample). If such application and drawing are not available for disclosure, please send us a blank application form, etc., if possible.

An empty application form to be filed in paper form (including fax) and can be downloaded as well as explanatory notes at

紙ベース（ファックスを含む）で提出するための空欄の出願書式は、説明書とともに、以下のサイトでダウンロードできる。

<http://oami.europa.eu/ows/rw/pages/QPLUS/forms/nonelectronic/nonelectronic.en.do>

The PDF files are also attached to the return email.

Electronic filings can be filed at

ここにある PDF ファイルを、返信メールにも添付した。
電子出願は以下のサイトで行うことができる。

<http://oami.europa.eu/ows/rw/pages/QPLUS/forms/electronic/fileApplicationRCD.en.do>

Help files can be found on the same page.

ヘルプファイルも同じページにある。

- 14** Is it possible for you to send us a sample registration certificate? Again, we would appreciate if you could send us such a certificate with all the sections filled in with information as a sample. If such certificate is not available for disclosure, please send us a blank certificate form, if possible.

All certificates are public and can be downloaded by searching for the publication online at <http://oami.europa.eu/RCDOnline/RequestManager> (e.g. rcd 001144315-0001) and by clicking

on the icon  which can be found at the bottom of the page.

Find also a copy of this example attached to the email.

登録証はすべて公開されており、このサイトで検索（例：rcd 001144315-0001）して、ページ下部にある矢印アイコンをクリックすることでダウンロードできる。

このサンプルもメールに添付した。

You are here: [Home](#) > [Quality plus](#) > Databases**RCD-ONLINE - Design consultation service - RCD information**

- Overview
- Design
- Representation
- Indication of the product
- Owner
- Representative
- Designer
- Exhibition
- Priority
- Publication
- Renewals
- Download RCD information
- Link to RCD Bulletin online
- List of invalidity decisions

RCD-ONLINE - Design consultation service - RCD information

International registrations of industrial designs administered by WIPO can now provide protection for the entire EC. Consult the Hague Express Database by clicking [here](#).



Design number : 001144315-0001
Number of results : 1 of 1

**Design**

Filing date: 08/06/2009
Registration date: 08/06/2009
Publication date (A1): 10/07/2009
Expiry date: 08/06/2014
Locarno class-subclass: 19.06 ([EUROLOCARNO](#))
Verbal element:
Status: Registered and fully published (A1) ([Glossary](#))
Language of filing: English
Second language: Spanish

Representation

+ 0001.1



+ 0001.2



+ 0001.3



+ 0001.4



+ 0001.5

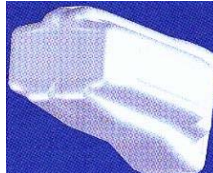

+ 0001.6

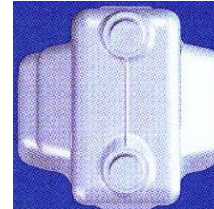

+ 0001.7

**Indication of the product**

Indication of the product: Ink container ([EUROLOCARNO](#))

Owner

Name of the owner: Olympus Corporation
ID number: 1595
Natural or legal person: Legal entity
Address: 43-2, 2-Chome, Hatagaya, Shibuya-ku

Post code:
Town:
Country:
Correspondence address:
Telephone:
Fax:
E-mail:

Tokyo
 JAPAN
 Olympus Corporation 43-2, 2-Chome, Hatagaya,
 Shibuya-ku Tokyo JAPÓN

Representative



Name of the representative: ELZABURU, S.L.P.
ID number: 11849
Natural or legal person: Legal entity
Address: Miguel Angel, 21
Post code: 28010
Town: Madrid
Country: SPAIN
Correspondence address: ELZABURU, S.L.P. Miguel Angel, 21 E-28010 Madrid
 ESPAÑA
Telephone: 917009400
Fax: 913193810
E-mail: elzaburu@elzaburu.es

Designer



Name of the designer or team of designers: Inoue Kyoichi
ID number: 69342

Exhibition



No entry for design number: 001144315-0001

Priority



Country: JAPAN
Date of application: 15/12/2008
Number of application: 2008-031832

Publication



Bulletin number: [2009/132](#)
Date of publication: 10/07/2009
Part: A.1



Registration Certificate
 4 pages | 3885 Kb

Renewals



No entry for design number: 001144315-0001



Last updated on: 20/02/2013



OFFICE FOR HARMONIZATION IN THE INTERNAL MARKET (OHIM)

APPLICATION FOR REGISTERED COMMUNITY DESIGN

For receiving office	Date of receipt (DD/MM/YYYY) <input style="width: 100%;" type="text"/>	Number of pages (including this one) <input style="width: 100%;" type="text"/>	Mod.001
For OHIM	Date of receipt (DD/MM/YYYY) <input style="width: 100%;" type="text"/>	Number of pages (including this one) <input style="width: 100%;" type="text"/>	

Application Type	Applicant/representative reference (not more than 20 characters)										
Multiple application <input type="checkbox"/>	*Language										
Number of designs <input type="text"/>											
Deferment ¹ <input type="checkbox"/>	Language of the application or ISO code <input style="width: 100%;" type="text"/>										
Specimen ² <input type="checkbox"/>	Second language										
	<table border="1" style="display: inline-table; border-collapse: collapse;"> <tr> <td style="width: 20px; text-align: center;">ES</td> <td style="width: 20px; text-align: center;">DE</td> <td style="width: 20px; text-align: center;">EN</td> <td style="width: 20px; text-align: center;">FR</td> <td style="width: 20px; text-align: center;">IT</td> </tr> <tr> <td style="text-align: center;"><input type="checkbox"/></td> <td style="text-align: center;"><input type="checkbox"/></td> <td style="text-align: center;"><input type="checkbox"/></td> <td style="text-align: center;"><input type="checkbox"/></td> <td style="text-align: center;"><input type="checkbox"/></td> </tr> </table>	ES	DE	EN	FR	IT	<input type="checkbox"/>	<input type="checkbox"/>	<input type="checkbox"/>	<input type="checkbox"/>	<input type="checkbox"/>
ES	DE	EN	FR	IT							
<input type="checkbox"/>	<input type="checkbox"/>	<input type="checkbox"/>	<input type="checkbox"/>	<input type="checkbox"/>							

Applicant³	ID number <input style="width: 100%;" type="text"/>	<input type="checkbox"/> legal entity <input type="checkbox"/> natural person
*Name of legal entity or first name and surname		
Legal form of the entity		
Tel, fax, e-mail		
*Address		
Street and number		
City and postal code		
Country		
Postal address (if different)		
Nationality / State of incorporation		

Representative³	ID number <input style="width: 100%;" type="text"/>	
Name		
Tel, fax, e-mail		
Address		
Street and number		
City and postal code		
Country		
Postal address (if different)		
Type of representative	<input type="checkbox"/> legal practitioner <input type="checkbox"/> professional representative <input type="checkbox"/> association of representatives <input type="checkbox"/> employee	

Fee check-list	TOTAL	*Payment of fees
Registration fee (1st design)	230 €	Current account with OHIM
for 2 nd to 10 th design (115 € x . . .)	0 €	<input type="checkbox"/> Account No <input style="width: 100%;" type="text"/>
from 11 th onwards (50 € x .0.)	0 €	<input type="checkbox"/> Do not use my current account with OHIM
Publication fee (1st design) 120 €	120 €	Transfer to account of OHIM
for 2 nd to 10 th design (60 € x . . .)	0 €	<input type="checkbox"/> Banco Bilbao Vizcaya Argentaria
from 11 th onwards (30 € x .0.)	0 €	<input type="checkbox"/> La Caixa
Fee for deferment of publication (1st design) 40 €		Date of transfer (DD/MM/YYYY) <input style="width: 100%;" type="text"/>
for 2 nd to 10 th design (20 € x . . .)	0 €	
from 11 th onwards (10 € x .0.)	0 €	
TOTAL AMOUNT PAID	350 €	

Signature	
Name <input style="width: 100%;" type="text"/>	*Signature <input style="width: 100%;" type="text"/>

#DS001EN

¹ Mandatory details
¹ Please tick the box if the application contains at least one design of which publication is deferred
² Please tick the box if the application contains at least one specimen of a two-dimensional design
³ If more than one or if space provided is not sufficient, please continue on the attachment sheet



APPLICATION FOR REGISTERED COMMUNITY DESIGN (continuation)

Reproduce this sheet in case of more than 1 design (use 1 sheet per design)

<input type="checkbox"/> Tick the box if the following data is the same for all designs contained in the application		Mod.002
Design number <input type="text"/> out of total of <input type="text"/>	Applicant name	
*Indication of product(s) ¹ <input type="checkbox"/> Same indication of product for all designs	Locarno classification	
Convention priority²		
<input type="checkbox"/> Same priority for all designs <input type="checkbox"/> Document attached		
Country of first filing or ISO	<input type="text"/>	
Date of first filing ³	/ /	
Filing number	<input type="text"/>	
Exhibition priority²		
<input type="checkbox"/> Same priority for all designs <input type="checkbox"/> Document attached		
Name of the exhibition	<input type="text"/>	
Date and place ³	/ /	
Date of first disclosure ³	/ /	
Designer²		
<input type="checkbox"/> Same designer for all designs <input type="checkbox"/> Waiver		
Name	<input type="text"/>	
Address	<input type="text"/>	
Miscellaneous		
<input type="checkbox"/> Request for deferment of publication <input type="checkbox"/> Number of views		
<input type="checkbox"/> Design filed with a specimen ⁴		
Brief description of the representation/specimen⁵		
<input type="text"/>		

* Mandatory details

¹ Indicate the usual generic name of the product(s) in which the design is intended to be incorporated or to which it is intended to be applied, preferably using the term(s) included in the EuroLocarno Database. If the space provided is not sufficient, please continue on the attachment sheet

² If more than one, please continue on the attachment sheet

³ (DD/MM/YYYY)

⁴ Filing with a specimen is only allowed in the case of deferment (see explanatory notes)

⁵ Please continue on the attachment sheet if the space provided is not sufficient

page number

of



REPRESENTATION/SPECIMEN SHEET

Reproduce this sheet if space is not sufficient
A representation / specimen per design is mandatory

Number of views	Design number(s)	out of total of	Applicant name

Mod.003

page number

	of	
--	----	--



ATTACHMENT SHEET

Applicant name

Mod.004

This sheet should be used for any additional information relating to :

additional applicant, additional representative, additional priority, additional designer, indication of product, brief description.

Please specify the field name(s) for each additional information

--

page number

	of	
--	----	--

知的財産担当官庁への意匠の表現に関するヒアリング

国名：韓国

訪問（又は電話会議）日：2012年11月2日 14時～15：30時

訪問官庁：韓国特許庁

官庁対応者 役職／氏名（可能であれば記入してください）：デザイン審査政策課 書記官 安銑燁
事務所／訪問者 氏名：KIM & CHANG 商標部 部長 王永成、課長 李東勲

質問 1 意匠の表現に関する基本的な考え方について

質問 1-1 貴国には、法令、審査基準、審査ガイドライン等に意匠出願における意匠の開示に関する規定があります。これらの規定の根底にある考え方において、意匠の開示の程度はどのような考え方に基づいて定められているのでしょうか。すなわち、意匠の開示の程度は何を重視して決定されているのでしょうか。以下に理由を例示しますが、具体的にお教えてください。

- ・方式審査又は実体審査を容易にするため
- ・提出された表現物（図面、写真、見本など）の保管を容易にするため
- ・意匠制度利用者の負担を軽減するため
- ・第三者（意匠出願人／権利者以外の者）の理解を容易にするため
- ・権利行使をしやすくするため
- ・基本的に意匠を開示する出願人の自己責任に委ねるため

回答欄 1-1

デザイン保護法第 23 条の 2 により、出願人は自己のデザイン登録出願についての公開を申請することができ、デザイン登録出願人は出願公開があった後にそのデザイン登録出願されたデザイン又はこれに類似するデザインを業として実施した者にデザイン登録出願されたデザインであることを書面をもって警告することができる。

即ち、権利行使をしやすくするために出願公開規定が利用される。

質問 1-2 デザイナーは 3D-CAD を使い、コンピューター・グラフィックを描いて工業製品を設計する場合があります。貴国では、以下の例示のような製品設計に用いた 3D コンピューター・グラフィックを、意匠の表現として意匠出願に用いることを認めていますか。

【意匠に係る物品】 取付け用手洗い器
【国際意匠分類】 23-02
【意匠に係る物品の説明】 本願意匠は、医療施設等において、主にスタッフの手洗い時に使用される。
【意匠の説明】 各図面はCGにより作成した図面であり、各図面の表面部全面に表された濃淡は、立体表面の形状を表す濃淡である。

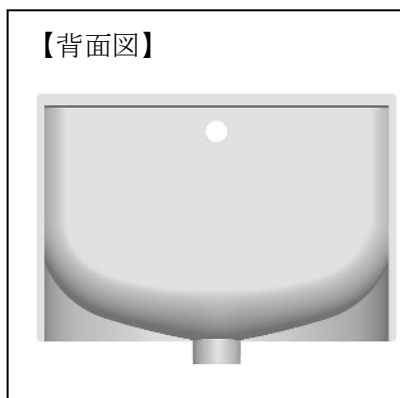
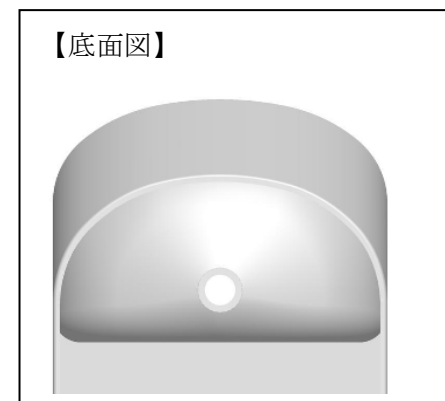
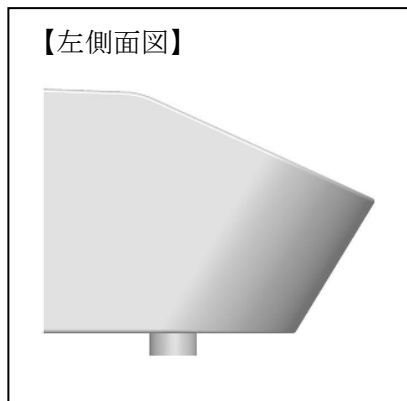
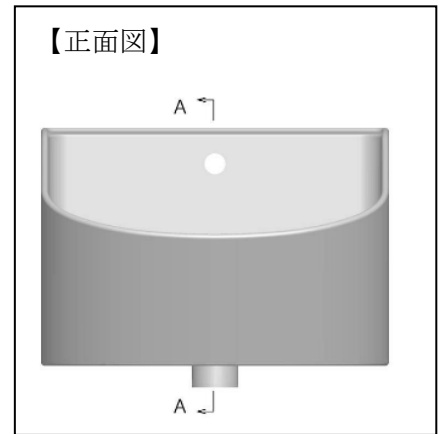
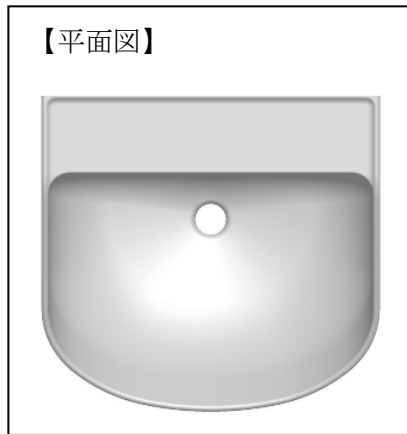

日本意匠登録第 1442550 号

回答欄 1-2

デザイン保護法施行規則により、3Dモデルリングファイル(3DS, DWG, DWF, IGES)の提出も認められる。

質問 2 物品の部分に係る意匠を保護する制度（部分意匠制度）における意匠の表現について

質問 2-1 部分意匠制度を有する、あるいは物品の一部が保護される国の知的財産担当官庁の方にご質問します。部分意匠制度を有しない、あるいは物品の一部が保護されない国の知的財産担当官庁の方は、質問 2-1 には回答せず質問 2-2 を回答してください。

以下の 2 つの部分意匠の表現例を具体的にお示しします。(例 1) は保護を受けようとする部分の意匠を、その他の部分と違った色を用いて区別をした図面です。(例 2) は保護を受けようとする部分の意匠を、その他の部分と違った線種（破線）で描いて区別をした図面です。貴国の制度下では、このような部分の意匠の表現は認められますか。それぞれについて認められるか否か、またその理由をお答えください。

(例 1) 保護を受けようとする部分の意匠を、その他の部分と違った色を用いて区別をした例

【意匠に係る物品】 乗用自動車

【国際意匠分類】 12-08

【意匠の説明】 図面中ピンク色で示された部分以外の部分が部分意匠として意匠登録を受けようとする部分である。底面図は重量物につき省略した。各図の表面部全面に表された濃淡は、立体表面の形状を表す濃淡である。

【斜視図】



【正面図】



【背面図】



【左側面図】



【右側面図】



【平面図】

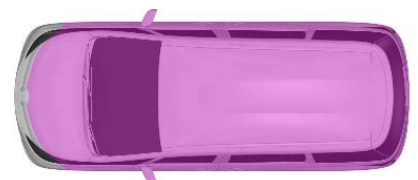

日本意匠登録第 1444223 号

(例2) 保護を受けようとする部分の意匠を、その他の部分と違った線種で描いて区別をした例

【意匠に係る物品】 包装用容器

【国際意匠分類】 09-01、09-02、09-03、09-04、09-05、28-01

【意匠の説明】 実線で表した部分が、部分意匠として意匠登録を受けようとする部分である。背面図は正面図と対称に表れる。底面図は平面図と同一に表れる。キャップ部分の拡大背面図はキャップ部分の拡大正面図と対称に表れる。キャップ部分の拡大底面図はキャップ部分の拡大平面図と同一に表れる。

【正面図】



【平面図】



【左側面図】



【右側面図】

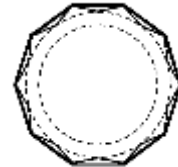

【キャップ部分の拡大斜視図 1】

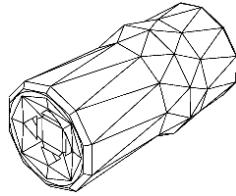

【キャップ部分の拡大斜視図 2】

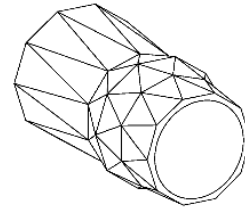

【キャップ部分の拡大正面図】

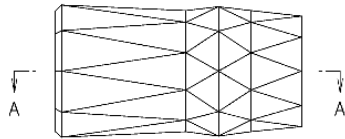

【キャップ部分の拡大平面図】

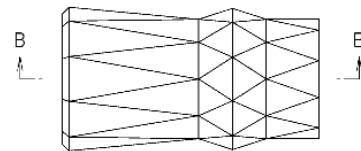

【キャップ部分の拡大左側面図】

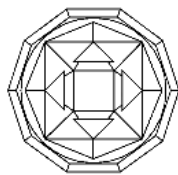

【キャップ部分の拡大右側面図】

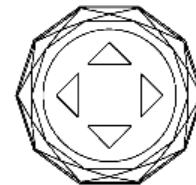

【A-A端面図】

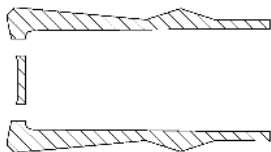

【B-B端面図】

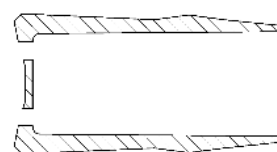

回答欄 2-1

デザイン保護法施行規則により全て認められる。

質問 2-2 部分意匠制度を有しない、あるいは物品の一部が保護されない国の知的財産担当官庁の方にご質問します。部分意匠制度を有する、あるいは物品の一部が保護される国の知的財産担当官庁の方は本質問には回答せず質問 3 に進んでください。

意匠制度のユーザーから物品の部分の意匠の保護を認めて欲しいとの要望はありませんか。たとえば特徴的・独創的な部分のみを模倣して取り込み、全体としては異なった意匠とするような、部分の意匠の模倣に対しては部分意匠制度が効果的と考えられますがそのようなニーズはありませんか。

回答欄 2-2

質問 3 意匠の特定および認定の考え方について

貴国が、方式審査のみを行って登録する制度、実体審査まで行って登録する制度、あるいは一部の出願に対して実体審査を行って登録する制度、のいずれの制度を採用しているかは別として、以下の質問にご回答ください。

質問 3-1 出願された意匠の方式審査において、意匠の認定をどの程度まで行っていますか。以下に程度を例示しますが、具体的にお教えてください。

- ・提出された図面あるいは写真の枚数、サイズなど規定された形式的要件を満たしているかのみを判断し、具体的な意匠の認定は行わない。
- ・形式的な要件に加え、意匠にかかる物品を考慮し、提出された図面あるいは写真等を精査して意匠を認定し、規定通りに意匠が開示されているかを判断する。
- ・意匠を認定した結果、意匠の実体的登録要件を満たしていないと判断された場合（明らかに新規性がない場合等）は、実体審査まで踏み込んで行う。

回答欄 3-1

韓国の方式審査は出願書の書誌事項、手数料納付などの形式的な事項に対してのみ審査を行い、デザインについての審査は行わない。

質問 3-2 質問 3-1 における方式審査はだれが行っていますか。方式審査官、事務スタッフ又は、それ以外の担当者（実体審査官も含む）ですか。具体的にお教えてください。

回答欄 3-2

特許庁出願課の方式担当主務官

質問 3-3 登録された意匠に対して、その意匠が権利範囲を特定できないなど不明確であるという理由で権利を無効化する制度としてどのようなものがありますか。以下に制度を例示しますが、具体的にお教えてください。

- ・ 知的財産担当官庁に対する審査請求
- ・ 知的財産担当官庁に対する無効審判の請求
- ・ 裁判所に対する提訴

回答欄 3-3

審査登録件は無効審判、無審査登録件は異議申立(公告日より 3 月以内)又は無効審判

質問 3-4 意匠の表現の明確性が争点となった判例はありますか。あればどのような意匠の表現が不明確とされたか判決の要旨をお教えてください。

回答欄 3-4

検索されない。

質問 4 補正の考え方について

質問 4-1 意匠出願の補正は可能ですか。可能であれば時期的、内容的にどのような制限がありますか。法令、審査基準、審査ガイドライン等の規定以外に実務上、特筆すべき点があればお教えてください。また、自発的な補正は認められますか。

回答欄 4-1

デザイン保護法第 18 条により可能であり、出願の要旨を変更しない範囲内において、デザイン登録決定又はデザイン登録拒絶決定の通知書が送達される前までであれば行うことができる。自発補正も認められる。

質問 4-2 補正の内容として提出が認められているものにはどのようなものがありますか。法令、審査基準、審査ガイドライン等の規定以外に実務上、提出が認められるものがあれば教えてください。

回答欄 4-2

デザイン保護法第 17 条の手続の補正(①未成年者・準禁治産者・禁治産者は法定代理人によらなければ、デザイン登録に関する出願・請求、その他の手続をすることができない。②この法律又はこの法律に基づく命令で定める方式に違反した場合。③納付すべき手数料を納付しない場合。)及び同法第 18 条の出願の補正(①図面・図面の記載事項及び写真或いは見本、②単独・類似デザインの変更、③審査・無審査出願の変更)

質問 4-3 補正指令によってなされた補正、あるいは自発的になされた補正が認められなかった場合は、どのような扱いになりますか。意匠出願が却下される場合はありますか。あるいは、瑕疵が軽微であれば補正が認められ登録され得る場合もありますか。

回答欄 4-3

デザイン保護法第 18 条の 2 により、補正が出願の要旨を変更する場合は、その補正を却下する。デザイン登録出願人は補正却下に対して、その拒絶謄本が送達された日より 30 日以内に不服審判を請求することができる。

質問 4-4 形式的には要件を満たしているが、意匠を認定しやすくするために又は意匠をより明確にするために、知的財産担当官庁から意匠の表現に関しての補正を促す通知をする場合がありますか。また、それはどのような内容の通知ですか。具体的にお教えください。

回答欄 4-4

工業上利用可能なデザイン(工業的生産方法により同一の物品を量産できるデザイン)ではない場合は、意見提出通知書を通じて補正を要求する。

質問 4-5 質問 4-4 における通知がなされた場合、出願人が応答する補正は知的財産担当官庁の指示通りにしなければ認められませんか。それとも補正の自由度が認められ、補正内容が出願人に委ねられる場合がありますか。具体的にお教えください。

回答欄 4-5

担当審査官の指示に反し、補正が出願の要旨を変更する場合はその補正は却下される。

質問 4-6 意匠出願を分割して新たな意匠出願とすることは可能ですか。このような分割出願が可能であれば、時期的、内容的にどのような制限がありますか。法令、審査基準、審査ガイドライン等の規定以外に実務上、特筆すべき点があればお教えください。例えば、全体意匠の一部分を分割して新たな部分あるいは部品の意匠出願とすることは認められるでしょうか。

回答欄 4-6

デザイン保護法第 19 条により、2 以上のデザインを 1 デザイン登録出願した者及び複数デザイン登録出願した者は、デザイン登録決定又はデザイン登録拒絶決定の通知書が送達されるまでに分割出願することができる。但し、全体意匠の一部分を分割して新たな部分あるいは部品の意匠出願とすることは認められないと解釈される。

質問 4-7 出願日が認定されるためには、具体的に意匠の表現の要件が満たされて意匠の認定ができなければなりませんか。それとも意匠の認定は行われることなく形式的な要件（図面あるいは写真の枚数、サイズなど）が満たされていれば出願日が認定されますか。

回答欄 4-7

現行デザイン保護法施行規則第 2 条により、出願書類に重大な瑕疵がある場合は書類が不受理返送され出願日は認められない。

質問 4-8 質問 4-7 の場合に、出願日認定の要件を満たしていないとして知的財産担当官庁から補正指令が出されて、出願人が補正応答した結果、出願日の認定の要件を満たした場合、出願日は最初に出願をした日ですか、それとも補正書を提出した日ですか。

回答欄 4-8

出願書類が不受理返送されず補正できる場合は出願日が認められる。但し、デザイン保護法第 18 条第 6 項により、補正が最初のデザイン登録出願の要旨を変更するものであってデザイン権の設定登録があった後に認められたときは、そのデザイン登録出願はその補正書を提出した時にデザイン登録出願したものとみなす。

質問 4-9 出願日認定の要件として、具体的に意匠の認定を行う知的財産担当官庁の方は以下の質問にお答えください。それ以外の知的財産担当官庁の方は質問 5 に進んでください。

質問 4-8 の場合に、提出した補正が意匠の要旨を変更するものであった場合、補正はどのように取り扱われますか。却下されますか、それとも補正応答書を提出した日を出願日とする新たな出願として取り扱われますか。具体的にお教えください。

回答欄 4-9

補正がデザインの要旨を変更するものであった場合は却下される。

質問 5 単一性の考え方について

質問 5-1 一の意匠と認められる、意匠の表現の要件についてお教え下さい。

例えば、物理的に離れて使用されるものであっても意匠的なまとまりがあれば一意匠と認める（入れ子状に重ねられる鍋等）、形態¹が類似していればセットものは一意匠と認める、一つの図面に物理的に離れて表現されていても同時に使用されるものは一意匠と認める（ペンとキャップ等）、別物品であっても同時に使用されれば認める（置物と台等）等、具体的にお教えください。また、一意匠と認めるか否かの判断は方式要件（方式審査で判断される）／実体要件（実体審査で判断される）のどちらですか。認められない場合は、官庁側はどのように扱いますか。

例) 日本では、(1) 二位以上の物品の区分を願書の「意匠に係る物品」の欄に並列して記載した場合、(2) 二以上の物品の図面を表示した場合、(3) 部分意匠では、物理的に分離した二以上の部分が含まれる場合は、拒絶の理由となり、その対応として分割することができます（実体要件）。

回答欄 5-1

デザイン審査基準第 12 条により、「2 以上の物品を結合して出願された物品」の 1 物品又は多物品に該当するか否かは、その結合状態からみて各物品の機能・用途が喪失され新しい一つの機能・用途と認識され得るか否かを基準に判断する。

また、1 デザインと認めるか否かの判断は実体要件である。

質問 5-2 画像が保護される国の知的財産担当官庁の方にご質問します。画像が保護されない国の知的財産担当官庁の方は本質問には回答せず質問 6 に進んで下さい。

複数の画像が一意匠と認められる図面の表現にはどのような規定がありますか。また、一意匠と認めるか否かの判断は方式要件（方式審査で判断される）／実体要件（実体審査で判断される）のどちらですか。認められない場合は、官庁側はどのように扱いますか。

例) 日本では、変化前の画像と変化後の画像が物品の同一機能のための画像であり、かつ、変化前の画像と変化後の画像とが形態的な関連性があると認められれば、これら複数の画像を含んだ状態で一意匠として認められます。認められない場合は複数の意匠と判断され、拒絶の理由になります（実体要件）。

¹ ここで「形態」とは、物品の形状、模様若しくは色彩又はこれらの結合をいいます。以下、同様です。

回答欄 5-2

画像デザインに関する規定は特にないが、画像デザインは部分デザインに関する規定に従う。
また、1意匠と認めるか否かの判断は実体要件である。

質問 6 権利の効力範囲について

質問 6-1 意匠権の効力の及ぶ範囲を考える場合に、意匠の形態の類似について定義・概念はありますか。また、形態類似の概念、例えばデッドコピーに近いものか、あるいはどの程度の変形例（バリエーション）までをいうかについて、意匠権の効力の及ぶ範囲との関係を説示した判例があればお教えください。

回答欄 6-1

デザイン保護法第 41 条により、デザイン権者は業として登録デザイン又はこれに類似するデザインを実施する権利を独占する。
また、デザイン審査基準第 4 条第 4 項により、デザイン類否判断基準を規定している。

質問 6-2 物品の同一／類似また、物品の機能及び用途の同一／類似は、意匠権の及ぶ範囲にどのように考慮されますか具体的に教えてください。これらの関係について説示した判例があれば教えてください。

回答欄 6-2

デザイン審査基準第 4 条第 4 項により、同一又は類似の物品間においてのみ類否を判断する。
また、「同一物品」とは用途及び機能が同一のものをいい、「類似物品」とは用途が同一で機能が異なるものをいう。
大法院 1987 年 3 月 24 日付言渡し 86 フ 84 判決によると、「物品の同一性は物品の用途・機能等に照らし合わせて取引通念上同一種類の物品として認められるか否かによって決定されるべきである。」と判示している。

質問 6-3 図面あるいは写真に表されていない箇所は、意匠権の効力の及ぶ範囲にどのように影響を与えますか。具体的に教えてください。

回答欄 6-3

デザイン審査基準第3条第3項チ目により、一部の図面を提出せず図面だけでは物品の全体的な形態が明確に表現されたデザインではなくても、そのような表現不足を経験則により補充してみると、当該デザインの要旨が捉えられ当業者がそのデザインを実施できる程度であれば、表現が具体的なデザインとみなす。

質問 6-4 物品の一部がその機能に基づいて変化する意匠権の場合、意匠権の効力の及ぶ範囲は変化の過程における形態にも権利の効力が及びますか。それも変化する最初の形態及び最後の形態にのみ意匠権の効力が及びますか。

物品の一部がその機能に基づいて変化する意匠の具体例を以下に示します。これは、立体形状の物品（おもちゃ）の形状が変化する例です。

【正面図】



【背面図】

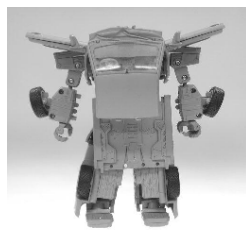

【左側面図】



【右側面図】



【平面図】



【底面図】



【変化の途中の状態の斜視図】



【変化をした状態の正面側からの斜視図】



【変化をした状態の背面側からの斜視図】



回答欄 6-4

デザイン審査基準第4条第4項ヌ目により、動的デザインの静止状態及び動作中の基本的主体をなす姿態が静的デザインと類似すれば、類似デザインとみなす。但し、動作の内容が特異であれば類似しないデザインとみなす。

質問 6-5 セットもの又は組物の意匠権の権利行使ができる範囲についてご回答ください。権利行使ができるのは、同じ物品で構成されているセットもの又は組物にのみに権利の効力が及ぶのか、それとも、これらを構成する単一物品だけで使用された場合にも権利の効力が及ぶでしょうか。

ここで、セットものの意匠とは、同時に使用される複数の物品からなりセット全体として統一感がある場合これらを一の意匠とするもので、組物の意匠とはセットものの意匠と概念は同じですが、規定によりセットの種類が定められている場合をいいます。

回答欄 6-5

デザイン保護法第12条第1項により、2以上の物品が一組の物品として同時に使用される場合、当該一組の物品のデザインが一組全体として統一性があるときは、1 デザインとしてデザイン登録を受けることができ、またデザイン審査基準第15条第2項ホ目により組物デザインに対しては組物全体でのみ登録要件を判断する。即ち、組物のデザインとその構成物品のデザインの間には法第16条の先出願規定は適用されないが、法第5条第3項の拡大された先出願規定は適用される。

質問 6-6 意匠権の間で利用関係が生じる場合についての権利行使の制限についてお教えてください。意匠権の間での利用関係は下記の3つの場合が考えられます。

- ①物品全体の意匠権と、その物品の一部を構成する部品（一の物品として単独に扱えるもの）の意匠権との間における利用関係
- ②物品全体の意匠権と、その物品の部分（物品の一部であり、部品として切り離すことができないもの）の意匠権との間における利用関係
- ③セットもの又は組物の意匠権と、これらを構成する単一物品の意匠権との間における利用関係

例えば、①のケースにおいて、物品全体の意匠権に係る意匠を実施あるいは権利行使をする場合、意匠権者は、部品の意匠権を有する意匠権者にライセンスの許諾を受ける必要があるなどの制限を受ける場合がありますか。②、③のケースについても同様にお教えてください。

回答欄 6-6

デザイン保護法第 45 条により、先出願が部品/部分/単一物品であり、後出願が完成品/全体/組物である場合は利用関係が成立し、先出願権利者の許可無しに自己の登録デザイン又はこれに類似するデザインを業として実施することはできない。

質問 6-7 複数の画像が一意匠として保護される国の知的財産担当官庁の方にご質問します。複数の画像が一意匠として保護されない国の知的財産担当官庁の方は本質問には回答せず質問 7 に進んで下さい。

複数の画像による意匠権と、これを構成する一つの画像による意匠権との利用関係について、権利行使に制限を受ける場合はありますか。

回答欄 6-7

画像デザインの場合は、先出願が複数の画像を構成する一つの画像であり、後出願が複数の画像である場合、利用関係が成立し、先出願権利者の許可無しに自己の登録デザイン又はこれに類似するデザインを業として実施することはできない。

質問 6-8 複数の画像が一意匠として保護され、実体審査を行っている国の知的財産担当官庁の方にご質問します。

一つの画像による先の意匠出願とその画像を一の構成要素とする複数の画像の出願がなされた場合、新規性及び創作非容易性の判断においてどのような措置をとっていますか。

回答欄 6-8

デザイン保護法第 26 条第 2 項により、無審査登録出願である画像デザイン出願は、新規性及び創作性（国内に広く知られた形状・模様・色彩又はこれらの結合によって容易に創作できるものは除く）の審査は行わない。

質問 7 出願図面による開示と公報による公示の考え方

質問 7-1 意匠公報掲載時（電子媒体による公報を含む）に出願された図面あるいは写真を加工（例えば、サイズ、比率の変更など）する場合はありますか。加工をする場合はその理由と加工の基準をお教えてください。

回答欄 7-1

加工する場合はあるが、加工の基準はない。

質問 7-2 意匠出願が電子媒体による場合、意匠の表現物は電子画像による記録以外にプリントアウトしたハードコピーも原本として保管をしていますか。保管をしている場合はその理由をお教えてください。

回答欄 7-2

保管していない。

質問 7-3 意匠出願から登録に至るまでの出願経過の書類（電子データを含む）は閲覧が可能ですか。また、閲覧が可能な場合はその条件（どのような内容まで閲覧が可能か、閲覧できない資料はないかなど）及び閲覧費用をお教えてください。

回答欄 7-3

デザイン保護法第 76 条により、出願公開されずにデザイン権の設定登録がされなかったデザイン登録出願に関する書類及び資料は公共の秩序又は善良の風俗を紊乱するおそれがあれば閲覧できる。

質問 8 貴国の法令、審査基準、審査ガイドライン等の規定によって定められている、意匠出願における意匠の表現について、また各国ごとに意匠の表現が異なることについて、意匠制度ユーザーから制度改正などの意見が出されていますか。どのような意見がだされているか具体的にお教えてください。

回答欄 8

多くの意見が出されている。例えば、今回デザイン保護法改正においては、グラフィックデザインに対しては反対意見が多かったため、それと関連する改正は取り消された。

質問 9 近年の意匠出願件数の傾向は増加傾向ですかそれとも減少傾向ですか。また、その要因として考えられることがあればお教えてください。

回答欄 9

デザイン出願件数は、2007年-54,362件、2008年-56,750件、2009年-57,903件、2010年-57,187件、2011年-56,524件である。

質問 10 ヘーグ協定加盟国の知的財産担当官庁の方にご質問いたします。ヘーグ協定に加盟する前後で意匠出願件数の変化はありましたか。

回答欄 10

2014年1月1日に施行予定

質問 11 ヘーグ協定加盟国の知的財産担当官庁の方は質問 11 には回答せず質問 12 へお進みください。

ヘーグ協定への加盟を準備調整中の知的財産担当官庁の方へご質問します。ヘーグ協定加盟に対して期待することは何ですか。具体的にお教えてください。

回答欄 11

自国民の便宜増進

質問 12 ヘーグ協定加盟国及び加盟準備調整中のいずれの知的財産担当官庁へもご質問いたします。ヘーグ協定加盟に際して、意匠の表現について自国の制度を変更・調整しなければならなかった点または今後変更・調整を行いたいと考えている点がありましたらお教えください。

回答欄 12

デザイン分類においてロカルノ分類の導入、グラフィックシンボルの保護

【情報提供依頼】

13 複数意匠一括出願を採用している国の知的財産担当官庁の方にお問い合わせがございませぬ。複数意匠一括出願の場合の願書及び図面の書き方の情報を入手いたしたく、公開できる願書及び図面のサンプル（各欄が記入済みのもの）があれば頂けないでしょうか。また、記入済みのものでは公開が難しい場合は、願書等のフォーマット（空欄のもの）でも構いませんのでご提供ください。

サンプルを添付致します。

14 登録証のサンプルをご提供いただけませんか。こちらも、各欄が記入済みのもので公開できるサンプルがあればそれをご提供いただきたく、記入済みのものでは公開が困難な場合はフォーマット（空欄のもの）でも構いませんのでご提供お願い申し上げます。

サンプルを添付致します。



디자인등록증

CERTIFICATE OF DESIGN REGISTRATION

등록제	호	출원번호	제 호
(REGISTRATION NUMBER)		(APPLICATION NUMBER)	
		출원일	년 월 일
		(APPLICATION DATE : YYMMDD)	
		등록일	년 월 일
		(REGISTRATION DATE : YYMMDD)	
		등록의 구분	심사등록
		(TYPE OF REGISTRATION)	(EXAMINED REGISTRATION)

디자인의 대상이 되는 물품 ARTICLE THAT IS THE OBJECT OF THE DESIGN

디자인권자 (OWNER OF THE DESIGN RIGHT)

창작자 (CREATOR)

위의 창작은 「디자인보호법」에 의하여 디자인 등록원부에
등록되었음을 증명합니다.

(THIS IS TO CERTIFY THAT THE DESIGN IS REGISTERED ON THE REGISTER OF THE KOREAN
INTELLECTUAL PROPERTY OFFICE.)

년 월 일



특 허 청
COMMISSIONER, THE KOREAN INTELLECTUAL PROPERTY OFFICE



Interview Survey on IP Offices Concerning Representations of Designs

Name of the Country: INDIA

Time and Date of Telephone conference): At 2.30 p.m. on November 5, 2012, At 10.30 p.m. on November 9, 2012 and At 11.30 a.m. and November 14, 2012.

Visited IP Office: NOT APPLICABLE

Name of the Person Representing the IP Office (Please write if possible): Dr. Sukanya Chattopadhaya, Controller of Designs

Names of the Visitor and the Firm: SHARAD VADEHRA from KAN AND KRISHME had telephonic conferences with the person representing the IP Office.

Question 1 Basic principle concerning representations of designs

Question 1-1 In the laws, regulations, examination guidelines, etc., of your country, there are provisions concerning the disclosure of designs. What is the underlying principle behind those provisions that determines the extent of disclosure of designs? In other words, when determining the extent of disclosure of designs, what are the primary goals of your country?

Example answers are listed below. Please give us a detailed answer.

- To facilitate formality examination or substantive examination.
- To facilitate storage of the submitted representations (drawings, photographs, specimens, etc.).
- To reduce the burdens on the users of the design system.
- To facilitate understanding of third parties (those other than design applicants and design holders)
- To facilitate the enforcement of rights.
- To ask for self-responsibility of the applicant who discloses his/her design.

Answer Section 1-1:

The main purpose for disclosure of design is to facilitate formal and substantive examination so that the design for which protection is requested meets all the formal and substantive requirements such as design under consideration is a ‘design’ under the Act; design is new or original; design is not prejudicial to public order or morality and security of India.[Section 2(d), 2(g), 5(1) and Section 46 of the Indian Design Act, 2000]. The disclosure of the design also facilitates enforcement of design right by determining the scope of the design protection and the determining the limit on copying of the registered design.

意匠開示の主たる目的は、方式・実体審査を容易にし、保護を求める意匠がすべての方式・

実体要件を満たしているかを確認できるようにすること。例えば「新規性または創作性があり、公序良俗に反しない、かつ安全保障にとって有害でないもの」（2000年意匠法第2条(d)、(g)、第5条(1)、第46条)。また、意匠の開示には、意匠保護の範囲や、登録意匠のコピーの制限を決めることで、権利行使しやすくするという目的もある。

Question 1-2 In many cases, designers design industrial products by using 3D CAD and CG software. Does your country allow design applicants to use the 3D CG images created in the stage of product design such as those shown below as design representations to be included in design application documents?

[Article which constitutes the Design] Attachable wash-basin
 [International Design Classification] 23-02
 [Description of the Article which constitutes the Design] This design will be used mostly by medical staff to wash their hands in medical facilities, etc.
 [Description of the Design] Each drawing was created using computer graphics software. The shading applied to the entire surface of the 3D configuration presented in each drawing shows the shape of the curved surface.

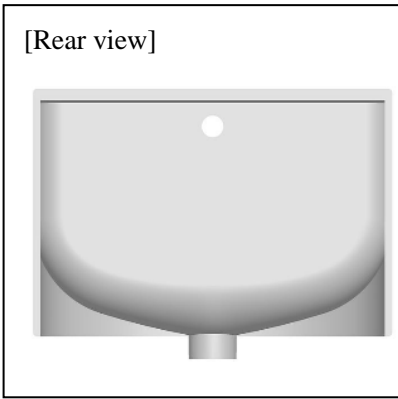
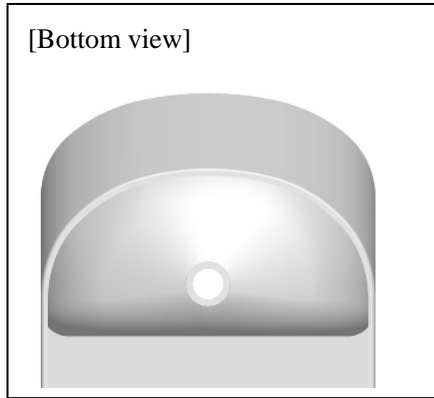
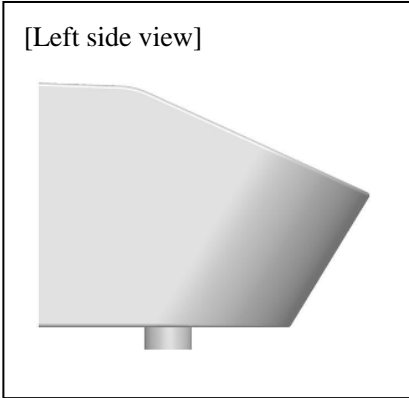
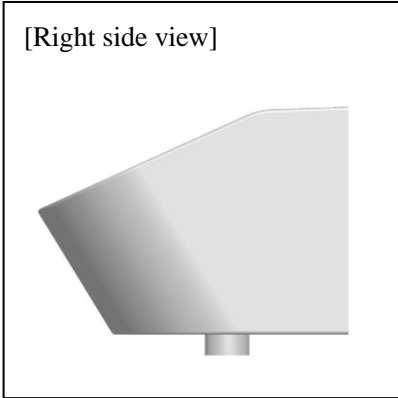
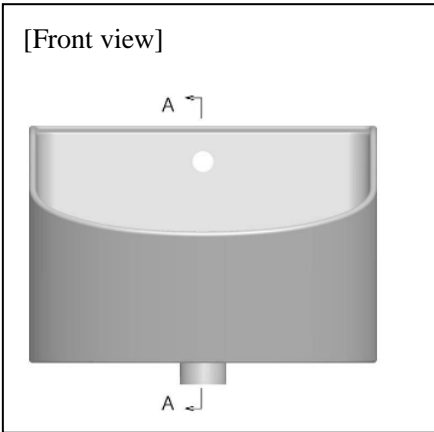
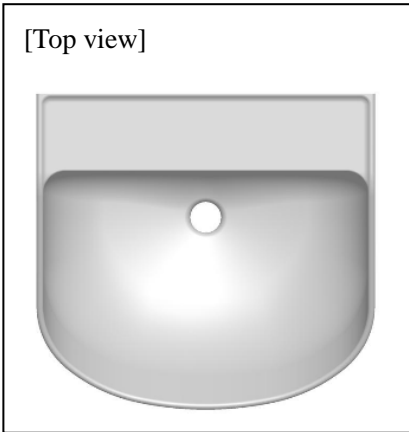
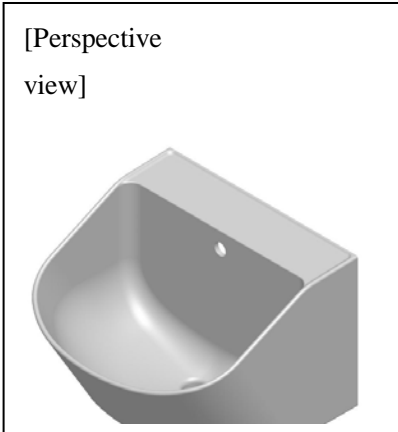

Japan Design Registration No. 1442550

Answer Section 1-2:

Rule 14 of the Design Rules, 2001 permits submission of the Computer Graphics (CG) in place of drawings, photographs etc. However, Computer Graphics in practice are rarely submitted. Further, there are no guidelines on such use. Generally photographs and drawings are submitted as representations of the design.

Further, no sectional views as shown above shall be incorporated in the representation sheet.

2001 年意匠規則の規則 14 において、図面や写真等の代わりにコンピュータグラフィック (CG) の提出が認められている。ただし現実には CG の提出はまれであり、その使用に関するガイドラインもない。一般には、意匠の表示として、写真や図面が提出される。また、意匠の表示用紙には、上図のような断面図を入れることはできない。

Question 2 Representations of designs under the system to protect the design of a part of an article (partial design system)

Question 2-1 This is a question to the IP Office of any country that has either a partial design system or a system to protect the design of a part of an article. If you are representing the IP Office of any country that has neither of these systems, please skip this question and answer Question 2-2.

Two specific examples of representations of partial designs are given below. In the case of Example 1, an applicant seeking protection for a partial design used a different color to distinguish the partial design from the rest of the article. In the case of Example 2, an applicant seeking protection for a partial design used a different line (broken line) to distinguish the partial design from the rest of the article. Does your country allow such representations of partial designs? Please tell us whether and why each of the following two methods shown in the following examples is permitted or not?

(Example 1) A case where an applicant seeking protection for a partial design used a different color to distinguish the partial design from the rest of the article

[Article which constitutes the Design] Passenger car
[International Design Classification] 12-08
[Description of the Design] The applicant is seeking registration of the partial design of the part other than the pink part shown in the drawings. The bottom view is omitted because this is a heavy article. The shading applied to the entire surface of the 3D configuration presented in each drawing shows the shape of the curved surface.

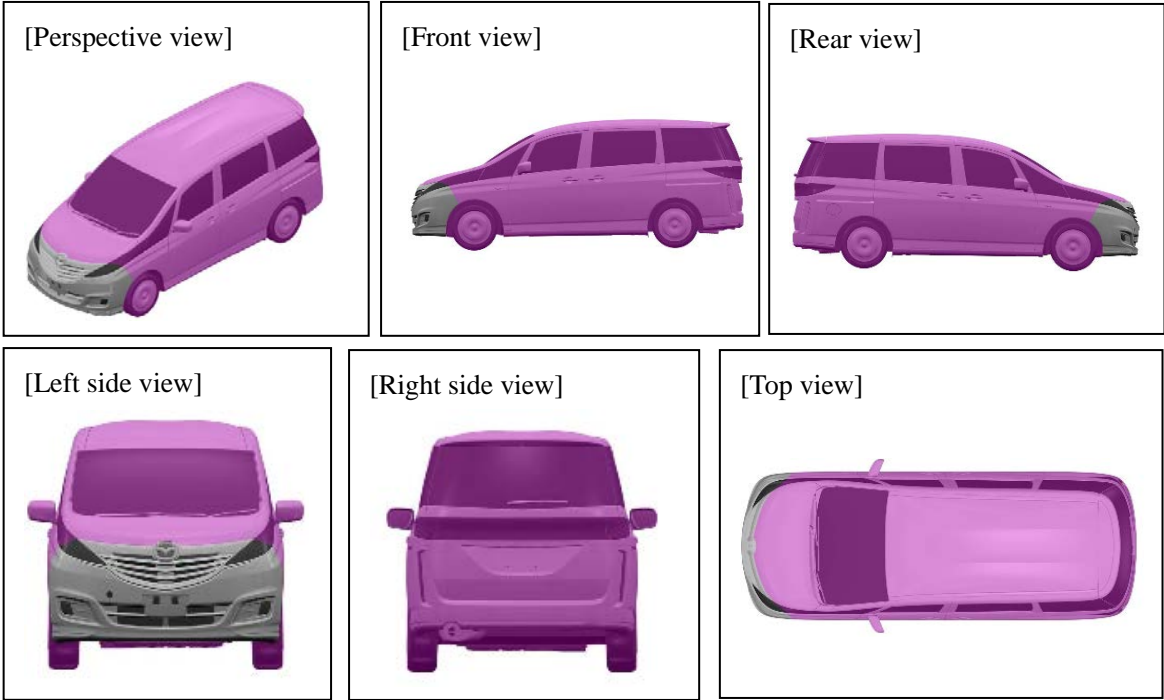

Japan Design Registration No. 1444223

(Example 2) A case where an applicant seeking protection for a partial design used a different line to distinguish the partial design from the rest of the article

[Article which constitutes the Design] Packaging container
 [International Design Classification] 09-01, 09-02, 09-03, 09-04, 09-05, 28-01
 [Description of the Design] The part drawn by a solid line shows the part for which the applicant is seeking registration as a partial design.
 The rear view is symmetrical to the front view
 The bottom view is the same as the top view.
 The enlarged rear view of the cap is symmetrical to the enlarged front view.
 The enlarged bottom view of the cap is symmetrical to the enlarged top view.

[Front view]



[Top view]



[Left side view]

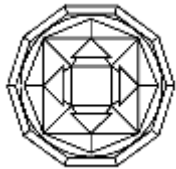

[Right side view]



[Enlarged perspective view of the cap 1]

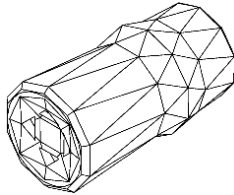

[Enlarged perspective view of the cap 2]

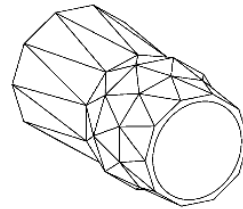

[Enlarged front view of the cap]

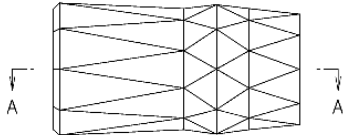

[Enlarged top view of the cap]

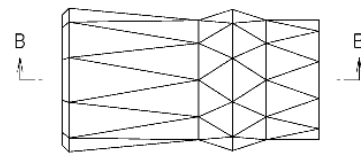

[Enlarged left side view of the cap]

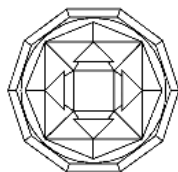

[Enlarged right side view of the cap]

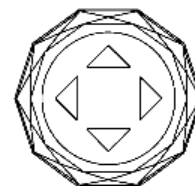

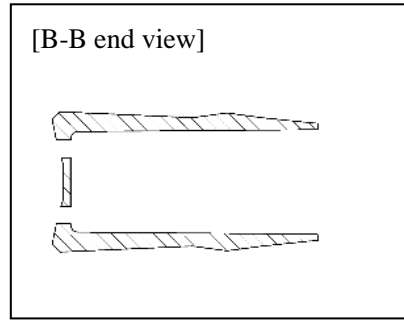
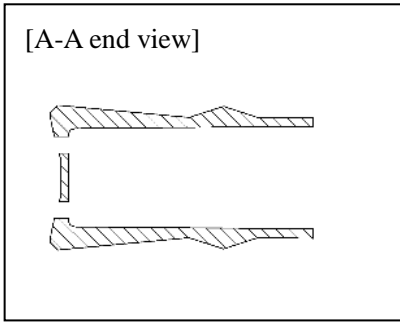

Japan Design Registration No. 1449069

Answer Section 2-1:

As such there is no partial design system in India. However, if the design is applied to a part of an article, design registration can be obtained for the entire article with the part to which the design is applied. Further, if novelty of the design lies in a part of the design, a statement of novelty is inserted highlighting novelty of the design in that part. Thus, in such cases “statement of novelty” to some extent serves the purpose of the partial design system in India.

インドには部分意匠制度はないが、物品の一部について意匠を出願した場合、その部分を含む物品全体に対する意匠登録を受けることができる。また、新規性が意匠の一部にある場合は、新規性の陳述を挿入して、意匠のその部分の新規性を目立たせる。したがって、このような場合は「新規性の陳述」がある程度、部分意匠制度の役割を果たしている。

Colouring may be used, on a black and white drawing, to highlight only those features of the design for which protection is sought. In such cases, it shall be clearly indicated in the novelty statement that the claim is restricted only to the portions depicted by colouring and the colours so given are not part of the design.

保護を求める意匠の特徴のみを目立たせるために、白黒の図面に色を使用することができる。この場合、クレームは色で示した部分のみに限定され、そのように使用された色は意匠の一部でないことを、新規性の陳述に明記しなければならない。

Dotted lines may be used in representation to indicate those elements of the article for which no protection is sought. Dotted lines identify elements which are not part of the claimed design. However, the Examiner generally objects to dotted lines at the time of the issuance of the Examination Report and ask for removal of the dotted lines from the drawings. Therefore, there exist an ambiguity, but as a matter of practice dotted lines are not allowed. Features of the design for which protection is sought must be shown in solid lines in the drawings.

表示において、保護を求めない物品の要素を示すために点線を使用できる。点線は、出願する意匠の一部でない要素を識別する。しかし、審査官は通常、審査レポートにおいて点線を拒絶理由とし、図面から点線を削除するよう求めてくる。したがって曖昧さが存在するが、事実上、点線は認められていない。保護を求める意匠の特徴は、図面において実線で示さなければならない。

Question 2-2 This is a question to the IP Office of any country that has neither a partial design system nor a system to protect the design of a part of an article. If you are representing the IP Office of any country that has either of these systems, please skip this question and answer Question 3.

Do the users of the design system of your country request protection for the partial designs of articles? For example, is there a need for the establishment of a partial design system, which is an effective countermeasure against infringers of partial designs who copy only a unique and innovative part of an article without copying the design of the article as a whole?

Answer Section 2-2:

As explained above, although India does not have partial design system, but statement of novelty highlighting novelty in particular part of an article to some extent serves the purpose of partial design. However, applicant for design application in India often claims protection for a part of an article. In India, we believe, there is a need to establish a system of partial design which may plug loophole which permits infringer to copy a part of the article where novelty lies without copying the article as a whole.

前述のように、インドには部分意匠制度はないが、物品の特定の部分を目立たせる新規性の陳述が、ある程度部分意匠の目的を果たしている。ただし、インドにおいても、出願人が物品の一部の保護を求める場合は多い。侵害者が物品全体をコピーしなくても、新規性のある物品の一部をコピーできるようにしている抜け穴をふさぐことが可能な部分意匠制度を設ける必要があると我々は考えている。

Further, in India, a part of article is a registrable design if it is capable of being made and sold separately and application for registration of such a design is made separately from the registration of a design for the whole article.

またインドでは、物品の一部であっても、個別に製造して販売でき、その意匠の登録を、物品全体の意匠の登録とは別に出願できる場合、その一部には登録可能性がある。

Question 3 The policy of conducting to find designs

Please answer this question regardless of whether your country has adopted a system that conducts only formality examination before registration, a system that conducts both formality examination and substantive examination before registration, or a system that conducts formality examination on all applications and conducts substantive examination only on certain applications before registration.

Question 3-1 In the course of formality examination on the design claimed in an application, to what extent do you conduct to find the design? Example answers are listed below. Please give us a detailed answer.

- We examine whether an application satisfies the prescribed formality requirements such as the number, sizes, etc., of the submitted drawings or photographs but do not examine the design in further detail.
- In addition to whether a design satisfies the formality requirements, we conduct to find out whether the design is disclosed in accordance with the relevant regulations by taking into consideration the article that embodies the design and checking the drawings, photographs, etc., submitted by the applicant.
- If we conduct to find design and determine that the design fails to satisfy the substantive requirements for design registration (e.g., the case where the design clearly lacks novelty), we conduct substantive examination as well

Answer Section 3-1:

In India, formal and substantive examination is done simultaneously by a single Examiner. Formality check is made on the basis of provisions in the Designs Act, 2002 and Designs Rules, 2001 alongwith Examination guidelines in the Manual of Design Practice and Procedure.

インドでは、方式審査と実体審査を、1名の審査官が同時に行う。方式審査は、2002年意匠法、2001年意匠規則、および意匠運用手順マニュアルの審査ガイドラインの規定に基づいて実施する。

Formality examination is carried out to determine whether:

- a. the application is in prescribed format?
- b. the prescribed fee has been paid?
- c. the name, address, and nationality of the applicant is mentioned?
- d. address for service is given in the application form?
- e. declaration of proprietorship is given in the application form?
- f. representation sheet is in a manner as prescribed in Rule 14?
- g. power of authority, if applicable, is filed?
- h. in case of reciprocity application:
 - I. the application was filed within the prescribed time?
 - II. the priority document was filed at the time of filing? If not, whether the priority document was filed within the extendable period of three months along with the prescribed form and fees?

方式審査では、以下のことを判断する。

- a. 出願は所定の様式になっているか。
- b. 所定の手数料が納付されているか。
- c. 出願人の氏名、住所、国籍が記載されているか
- d. 仕事上の住所が、出願書式に記載されているか。
- e. 所有権の宣言が、出願書式に記載されているか
- f. 表示用紙は、規則14に定める方式になっているか。
- g. 委任状は（必要な場合）提出されているか。

h. 相互主義出願の場合は、

I. 出願が所定期間内に提出されているか。

II. 出願時に優先権書類は提出されているか。提出されていない場合は、3カ月の延長期間内に、所定の書式と手数料とともに提出されたか。

Substantive examination is carried out to determine whether the design under consideration is:

a. a design‘ under the Act?

b. new or original?

c. prejudicial to public order or morality?

d. prejudicial to the security of India?

実体審査では、対象の意匠について次のことを判断する。

a. 意匠法に定める意匠か。

b. 新規性または創作性があるか。

c. 公序良俗に反しないか。

d. わが国の安全保障にとって有害でないか。

Question 3-2 Who conducts the formality examination mentioned in Question 3-1? Is it conducted by a formality examiner, Office staff member, or any other staff member (including a substantive examiner)? Please specify.

Answer Section 3-2:

In India, formal and substantive examination is done simultaneously by a single Examiner.

インドでは、1名の審査官が方式審査と実体審査を同時に行う。

Question 3-3 Do you have a system to invalidate a registered design right on the grounds that the design is unclear for such reasons as the design right having an unidentifiable scope? Example answers are listed below. Please give us a detailed answer. *

- System to file a request with the IP Office for commencement of examination

- System to file a request with the IP Office for an invalidation trial

- System to file a lawsuit with a court

*We believe your question pertains to whether invalidation of the registered design is possible. If you think otherwise, kindly revert to us.

*この質問は、登録意匠の無効化が可能かどうかに関する質問と理解する。そうでない場合は、お知らせいただきたい。

Answer Section 3-3:

In India, there is no provision which provides for filing request for Examination with the Design Office for commencement of the Examination. The Examination of the Design Application is done by the Design Office on its own as per the provisions of the Indian Designs Act, 2000 and Designs Rules, 2001.

インドには、審査を開始するために、庁に対して請求を提出できるようにする規定はない。意匠出願の審査は、2000年意匠法および2001年意匠規則の規定に基づいて、庁が独自に行う。

There is system to file invalidation request by any interested person under Section 19 of the Indian Designs Act before the Controller of the Designs after the registration of the design on the following grounds:

利害関係人が、意匠の登録後に次に掲げる理由により、意匠法第19条に基づいて無効化を長官に請求する制度がある。

The petition for cancellation of registration of a design may be filed on any of the following grounds:

- i. that the design has been previously registered in India;**
- ii. that it has been published in India or in any other country prior to the date of registration;**
- iii. that the design is not a new or original;**
- iv. that the design is not registrable under this Designs Act;**
- v. that it is not a design as defined under Section 2(d).**

登録意匠の取消申請は、以下の何れかの理由によって提出できる。

- i. 当該意匠が先にインドで登録されている。
- ii. 当該意匠が登録日前にインド又は何れかの外国で公開されている。
- iii. 当該意匠が新規性又は創作性のある意匠ではない。
- iv. 当該意匠が本法によれば登録可能ではない。
- v. 当該意匠が第2条(d)で定義した意匠ではない。

In a suit of Infringement, defendant can take grounds mentioned above in section 19 of the Act as defence and such a suit gets transferred to High Court. In such a proceeding, design may be invalidated on the grounds mentioned in Section 19 of the Act.

侵害訴訟では、被告は意匠法第19条に定める上述の理由に対して抗弁することができ、訴訟は高等裁判所へ上訴される。このような手続において、意匠は第19条に定める理由によって無効化することができる。

Question 3-4 Is there any judicial precedent where the clarity of a design representation was at issue? If yes, please summarize the judgment and tell us the grounds on which the court found the design representation to be unclear.

Answer Section 3-4:

Matters such as clarity of the design representation are taken care of at the time of the Examination of the Design Application at the Design Office. Such matters never proceed beyond the Design Office and therefore there is no court judgment in this respect.

意匠表示の明確性のような事項は、庁における意匠出願審査の時点で対処され、それよりも先の段階へ送られることはないため、そのような判例はない。

Question 4 Principle concerning amendments

Question 4-1 Is it permitted to amend a design application? If yes, what restrictions are imposed on an amendment in terms of time schedule and content? Please tell us any restrictions imposed on an amendment in practice other than those specified in the laws, regulations, examination guidelines, etc., that we should know about. Furthermore, is it permitted to make a voluntary amendment?

Answer Section 4-1:

Generally, the Design Application is amended during the examination process either to comply with the requirements/objections of the Examiner/Controller in the Examination Report or voluntarily.

意匠出願の補正は通常、審査プロセスにおいて、審査レポートにおける審査官／長官の要求／拒絶理由に対処するために行われるか、または自発的に行われる。

When amendments are made to comply with the requirement of the Examiner, the amendments are restricted only to the objections raised by the Examiner and time given by the Examiner to comply such objections. Additional views are filed generally to comply with the requirement of the Examiner/Controller and it is not permissible for the Applicant to file additional views on its own.

審査官の要求に対処するための補正は、審査官が挙げた拒絶理由に対する補正に限られ、審査官が定めた時間内に、その拒絶理由に対処する。通常は、審査官／長官の要求に対処するため追加の図が提出されるが、出願人が独自に追加の図を提出することは認められない。

As regards voluntary amendment, there is ambiguity under Indian Design Law. Rule 46 of the Designs Rules, 2001 provides for petition for amendments to be filed alongwith the prescribed official fee and such petition may be allowed on the discretion of the Examiner/Controller without detriment to any person and on such terms as Examiner/Controller may direct. However, there is no authoritative commentary or case law on the Rule 46 providing for the scope of amendments allowed under it. It is also not clear whether such amendments can be made both before and after registration of the design.

自発的な補正に関しては、インドの意匠法は曖昧である。2001年意匠規則の規則46によれば、所定の手数料を添えて提出された補正の申請は、何人の権利も害することなく、かつ審査官／長官が指令する条件に従い、審査官／長官の裁量によって認められる。しかし、規則46については、同規則で認められる補正の範囲を定める、権威ある解釈や判例法はなく、さらに、そうした補正は、意匠登録の前と後の両方において行えるかどうかについても明確ではない。

However, we may say that theoretically voluntary amendments are permitted at the sole discretion of the Examiner/Controller without detriment to any person and on terms which Examiner/Controller thinks fit. The Applicant cannot voluntarily add additional view in representation. The Examiner/Controller does not permit the Applicant to voluntarily file additional views which were not filed at the time of filing the Application. Additional views are filed generally to comply with the requirement of the Examiner/Controller]. However, we have not in our practice come across a single instance where voluntary amendment has been made by Attorneys.

しかし理論的には、自発的な補正は、何人の権利も害することなく、かつ審査官／長官が適切と考える条件に従い、審査官／長官の独自裁量によって認められると考えられる。出願人は、自発的に図を追加することはできない。審査官／長官は、出願時点で提出されていない追加の図を、出願人が自発的に提出することを認めない。追加の図は通常、審査官／長官の要求を満たすために提出される。ただし実際には、自発的な補正が代理人によってなされたという事例には、一度も遭遇したことがない。

Question 4-2 What may be submitted to make an amendment? Please tell us what may be submitted in practice other than those specified in the laws, regulations, examination guidelines, etc.

Answer Section 4-2:

There is very limited scope of amendment in India. Generally amendments are made to comply with the requirements/objections of the Examiner/Controller. As regards voluntarily amendments are concerned, there is no clarity on scope of such amendments. Additional views are filed generally to comply with the requirement of the Examiner/Controller].

インドでは、補正の範囲は非常に限定されている。補正は一般に、審査官／長官の要求または拒絶理由に対処するために行うものである。自発的な補正については、そうした補正の範囲が明確ではない。通常は、審査官／長官の要求を満たすために、追加の図が提出される。

Question 4-3 If the IP Office refuses to accept any amendment made in response to an amendment order or made voluntarily, what action would the IP Office take? Is there a possibility that the IP Office dismisses the design application? Or, if only a minor defect is involved, would the IP Office accept amendment and register the application which was amended?

Answer Section 4-3:

It depends on the discretion of the Examiner/Controller at the IP Office whether IP Office allows application with minor amendments. However, before dismissing design application, objection is raised or a hearing is appointed if the Applicant/Attorney applies for hearing within 3 months from the date of issuance of the Official Action. The filing reply to objections/hearing gives an opportunity to Applicant/Attorney to explain their point of view and further amend the application comply with the requirement of the Examiner/Controller if the Examiner/Controller is not willing to accept the application with the amendments.

知財庁が、わずかな補正によって出願を認めるかどうかは、審査官／長官の裁量にかかっている。ただし、意匠出願が却下される前には、拒絶理由が通知されるか、オフィスアクションの通知日から 3 カ月以内に出願人／代理人が口頭審理を申請した場合は、口頭審理の日程が決められる。拒絶理由に対する返答／口頭審理は、出願人／代理人にとって自身の見解を述べたり、審査官／長官が補正された出願を受理しない場合に、その要求を満たすためのさらなる補正を行う機会となる。

Question 4-4 Even though a design application is satisfied the formality requirements, are there any cases where the IP Office sends the applicant a instruction for an amendment related to a representation of the design in order to facilitate to conduct finding the design or to make the representation of the design more accurate? Please tell us what is stated in such a request in detail.

Answer Section 4-4:

In India formal and substantive examination is conducted simultaneously. Even if there is no objections on the ground of formal requirement, the Examiner/Controller often ask the Applicant/Attorney to amend the representation of the design as design claims “part of an article” which is not allowed as per Indian Design Act, 2000 and Design Rules, 2001. In such cases, the Examiner asks for the deletion of the dotted lines or broken lines to make design certain.

インドでは、方式審査と実体審査は同時に行われる。方式要件に基づく拒絶理由はなくても、2000年意匠法および2001年意匠規則で認められない「意匠の一部」をクレームして

いるとして、審査官／長官が、出願人／代理人に対して表示を補正するよう求めることがよくある。このような場合、審査官は、点線や破線を削除して、意匠を明確にさせるよう要求する。

Question 4-5 In the case mentioned in Question 4-4, if the IP Office sends an instruction to an applicant, is the applicant required to make an amendment strictly in accordance with the instruction? Or, is the applicant permitted to make an amendment in the way he/she wishes to a certain extent? Please explain in detail.

Answer Section 4-5:

The Applicant/Attorney is required to make amendments strictly as per the instructions given by the Examiner/Controller. If the Applicant/Attorney makes amendments which go beyond the requirement of the Examiner/Controller, it is discretion of the Examiner/Controller whether he/she accepts such amendment. Generally, such amendments are not accepted by the Examiner/Controller.

出願人／代理人は、審査官／長官の指示通りに補正をする必要がある。出願人／代理人が、審査官／長官の求めた範囲を超える補正を行った場合、受理するかどうかは、審査官／長官の裁量になる。通常は、そうした補正は受理されない。

Question 4-6 Is it permitted for a design applicant to divide the application and file a divisional application as a new design application? If we yes, what restrictions are imposed on the filing of a divisional application in terms of time schedule and content? Please tell us any restrictions imposed in practice other than those specified in the laws, regulations, examination guidelines, etc., that we should know about. For instance, is it permitted to divide a design application for a whole article and file a divisional design application for a new part or component?

Answer Section 4-6:

In India, no divisional application is allowed.

インドでは、分割出願は認められない。

Question 4-7 Before the according of the application filing date, is it necessary for the applicant to satisfy the requirements for representation of a design and a design should be found? Or, may the application filing date be accorded without finding a design as long as the formality requirements are satisfied (e.g., the number and size of drawings or photographs)?

Answer Section 4-7:

On receipt of an application, the Design Office accords a date and serial number to the application. Generally, filing date and serial number is allotted without conducting any detailed examination whether formal or substantive. Such objections are raised at a later stage. However, if the representation sheet is in such a form that the design cannot be visualised e.g. representation sheet received by fax, the application number shall not be allotted. Such an application shall be returned by post or at the counter itself, along with the fee, for non-fulfilment of basic requirements.

庁は出願を受理した時点で、出願日と出願のシリアル番号を認定する。通常は、出願日とシリアル番号は、方式か実体化を問わず、詳細な審査を行うことなく割り当てられる。詳細な審査による拒絶理由は、後の段階で提起される。ただし、表示用紙が、意匠を可視化できないような状態になっている場合、例えば、表示用紙がファックスで受理された場合などは、出願番号は割り当てられない。このような出願は、基本的要件が満たされていないという理由で、手数料を添えて、郵便または対面で返却される。

Question 4-8 In the case specified in Question 4-7, after an applicant makes an amendment in response to an order for amendment that the IP Office issued on the grounds that the requirements for according the application filing date were not satisfied, if said requirements are satisfied as a result of the amendment, which date does the IP Office accord as the application filing date, either the first application filing date or the date on which the amendment was submitted?

Answer Section 4-8:

If the requirement/objections are satisfied as a result of the amendments, first filing date is maintained as the filing date of the design application.

補正の結果として要求／拒絶理由が満たされた場合、最初の出願日が維持され、意匠出願日になる。

Question 4-9 In the case of an IP Office that conducts to find a design as a prerequisite for according the application filing date, please answer this question. In the case of any other IP Office, please skip this question and answer Question 5.

In the case mentioned in Question 4-8, if an amendment submitted to the IP Office changes the gist of the design, how would the amendment be treated? Would it be dismissed? Or, would it be deemed as a new application filed on the date on which the written answer to the order for amendment is submitted? Please explain in detail.

Answer Section 4-9:

Not applicable.
該当しない。

Question 5 Principle of unity

Question 5-1 Please tell us the requirements for representations of designs in order for multiple designs to be regarded as a single design.

Please give us a detailed answer. For example, is it the case that the designs of articles that are used in a physically separated manner may be regarded as a single design as long as those designs are regarded as a set in terms of design (e.g., a set of stackable pans), that a set of similar designs may be regarded as a single design as long as those designs are similar to each other in terms of configuration¹, that the designs represented in a drawing in a physically separated manner may be regarded as a single design as long as those articles are used simultaneously (e.g., a pen and its cap), or that the designs of different articles may be regarded as a single design as long as they are used simultaneously (e.g., a stationary article and its base)? Which requirements, either formality requirements (formality examination) or substantive requirements (substantive examination), must be met in order to recognize multiple designs as a single design? If multiple designs are not regarded as a single design, how would the IP Office treat them?

(Example) In Japan, a design application would be dismissed (i) if the applicant states two or more classifications of articles in the section entitled "Article which constitutes the design" of an application, (ii) if the applicant presents drawings of two or more articles, or (3) in the case of an application for the design of a part of an article, if the application covers two or more physically separated parts. If an application is dismissed for any of the aforementioned reasons, the applicant may file a divisional application (substantive requirements).

¹ "Configuration" means here that the shape, patterns or colors, or any combination thereof, of an article. The same shall apply hereinafter.

Answer Section 5-1:

In India, one application for multiple designs is not permissible. However, in one application a design for multiple articles can be claimed. A design may be registered in respect of more than one article in a class of goods. But a design cannot be registered for more than one class of goods. [Section 5 (3) of the Designs Act, 2000 and Rule 11(2) of the Designs Rules, 2001 and 3rd schedule of the Act.]

インドでは、多意匠一出願は認められない。ただし、1つの出願において、複数の物品に対する1つの意匠をクレームすることは可能である。1つの意匠を、同じ区分に属する複数の物品に関して登録することができる。しかし、2以上の区分に関して、1つの意匠を登録することはできない。[2000年意匠法第5条(3)、意匠規則11(2)、第3附則]

However, in India, design protection is allowed for the set.

Rule 2(e) of the Design Rules, 2001 defines Set to mean a number of articles of the same general character ordinarily sold together or intended to be used together, all bearing the same design, with or without modification not sufficient to alter the character or substantially to affect the identity thereof. For instance, tea set, dinner set, furniture set etc.

ただし、組物に対する意匠保護は認められる。

2001年意匠規則2(e)では次のように定義されている。「“組物”とは、同一の一般的特性を有し、通常一緒に販売されており、または一緒に使用されることを意図した多数の物品であって、その特性を変更するのに十分でないかまたは実質的にその同一性に影響を及ぼさない変更態様を有するか否かを問わず、全て同一の意匠を有するものを意味する」。例えば、茶器セット、ディナーセット、家具セットなどがある。

If a group of articles meets the requirements of a set, they can be registered under one application.

For a group of articles to be a set all three of the criteria in the definition of —set must be met. These are:-

(i) ordinarily on sale or intended to be used together

(ii) commonality of design (bearing the same design)

(iii) same general character

物品のグループが組物の要件を満たす場合は、1つの出願で登録できる。物品のグループが組物であるためには、セットの定義である次の3つの基準をすべて満たさなければならない。

(i) 通常一緒に販売されているか、一緒に使用されることを意図している

(ii) 意匠の共通性（同一の意匠を有する）

(iii) 同一の一般的特性

Rule 14(4) provides where an application is for a design as applied to a set, whether the given articles constitute a set or not, shall be determined by the Controller.

It is substantive requirement that an application for registration of design should relate to single design.

意匠規則14(4)では、組物に使用される意匠の出願において、所定の物品が組物を構成するか否かは、長官が決定すると規定されている。

また実体要件により、意匠登録の出願は単一の意匠に関するものでなければならない。

In India, application which relates to multiple designs are objected to at the time of

examination and such application are required to be amended by the Examiner/Controller to make them relate to single design. If the requirement as to the unity of the design is not complied with, the Application is rejected.

No divisional application is allowed as per Indian Design Act, 2000.

インドでは、複数の意匠に関する出願は、審査時に拒絶理由となり、単一の意匠に関するものになるよう、審査官／長官によって補正が要求される。意匠の単一性に関する要件に適合しない出願は拒絶される。

また、2000年意匠法において分割出願は認められていない。

Question 5-2 This is a question to the IP Office of any country that protects images. If your country does not protect images, please skip this question and answer Question 6.

Please tell us the provisions concerning representations of drawings that are required to be made in order to have multiple images regarded as a single design. Which requirements, either formality requirements (formality examination) or substantive requirements (substantive examination), must be met in order to have multiple images regarded as a single design? If multiple images are not regarded as a single design, how would the IP Office treat them?

(Example) In Japan, multiple images may be regarded as a single design covering multiple images in the case where the image before a change and the image after the change are used in relation to the same function of an article as long as those two images are considered to be related to each other in terms of configuration. If multiple images are not regarded as a single design, the application would be dismissed on the grounds that multiple images should be regarded as multiple designs (substantive requirements).

Answer Section 5-2:

This is a grey area. Images without specification of article are not allowed as no view of the article is possible which is a requirement of the Indian Designs Act. Further, in Images with the specification of article, there is 50% chance of success in getting registration. There is no precedent on registration of images under Indian Design Law. Multiple images cannot be regarded as a single design on the ground of unity of design (substantive examination). Further, there are no guidelines in India concerning representations of drawings that are required to be made in order to have multiple images regarded as a single design.

これはグレーゾーンである。意匠法の規定では、物品が表示されていない画像は認められないため、物品が指定されていない画像は認められない。さらに、物品が指定された画像において、登録が認められる可能性は50%である。インド意匠法に基づく画像の登録については、前例がない。複数の画像は、意匠の単一性の理由で、一意匠と見なされない可能性がある（実体審査）。また、複数の画像が一意匠と認められる図面の表現に関する指針はない。

Question 6 Scope of design protection

Question 6-1 Based on what definitions or ideas concerning the similarity of the configurations of designs do you determine the scope of design protection? Please give us any judicial precedent where the court presented its interpretation about how to interpret the scope of design protection from the perspective of configuration similarity, for example, whether the scope of design protection only covers almost identical designs or covers designs of different degrees of similarity (variations).

Answer Section 6-1:

Guidelines for determining scope of the design protection developed by judicial precedents over a period of time:

意匠保護の範囲を決定するための指針は、判例によって時間をかけて構築される。

- **There should be sufficient resemblance between the infringing design and the plaintiffs registered design to be found an action for infringement. *Britania Industries Limited v. Sara Lee Bakery* 2001 PTC 23 (Mad.),**

侵害意匠と原告の登録意匠との間に、侵害の訴えを認定するのに十分な類似性があること (*Britania Industries Limited v. Sara Lee Bakery* 2001 PTC 23 (Mad.))

- **It is not every resemblance in respect of the same article which would be actionable at the instance of the registered proprietor of the design. The copy must be a fraudulent or obvious imitation.**

登録意匠権者の求めにより、同一の物品に関するあらゆる類似性を訴えることができるわけではなく、不正または明らかな模倣でなければならない。

- **The word ‘imitation’ does not mean ‘duplication’ in the sense that the copy complained of need not be an exact replica *Castrol India v Tide Water Oil Co.* (1996) PTC 202(Cal) at p. 209. Therefore, the Court is required to see in particular as to whether the essential part of the base of the applicant’s claim for novelty in the design form part of the infringing design.**

「模倣」は、厳密な複製品（レプリカ）である必要はない (*Castrol India v Tide Water Oil Co.* (1996) PTC 202(Cal) at p. 209) という意味において「複製」を意味しない。したがって裁判所は特に、出願人による新規性のクレームのベースになっている本質的な部分が、侵害意匠の一部を構成するか否かを確認する必要がある。

- **The test for determining whether design is an imitation is for the eye because the finished article bearing the design must appeal to and is solely judged by the eye. A line may often be a thin one distinguishing a fraudulent imitation and an obvious imitation.** 意匠が模倣か否かを判断するテストは、視覚に関するものである。なぜなら、意匠を付した完成品は視覚に訴え、視覚によってのみ判断されるからである。不正な模倣や明らかな模倣を判断する境界線は、明確でない場合が多い。

- **Obvious imitation is something which is very close to the original design, the resemblance to the original design being immediately apparent to eye looking the two. *Dunlop Rubber Co. v Golf Ball Development* [1931] 48 RPC 268 at p. 279 followed in *Castrol India v Tide Water Oil Co.* (1996) PTC 202(Cal) at p. 209**

明らかな模倣とは、元の意匠に酷似しており、2つの意匠を見た際に、元の意匠への類似性が一目瞭然であるものをいう。*Dunlop Rubber Co. v Golf Ball Development* [1931] 48 RPC 268 at p. 279 followed in *Castrol India v Tide Water Oil Co.* (1996) PTC 202(Cal) at p. 209

- **In case of fraudulent imitation, imitation needs not to be obvious. It is sufficient if it is fraudulent that is to say, the imitation has been made with the intention to deceive another person with the knowledge that what is being done is a violation of the other person's right.**

不正な模倣は、明らかである必要はない。不正であること、つまり、他者の権利を侵害することを承知の上で、誰かを欺く意図で模倣をしたというだけで十分である。

- **Fraudulent imitation seems to an imitation to be an imitation which is based upon and deliberately based upon the registered design and is an imitation which may be less apparent than an obvious imitation, that is to say, you may have more subtle distinction between the registered design and a fraudulent imitation and yet fraudulent imitation although it is different in some respects from the original, and in respects which render it not obviously an imitation may yet be an imitation, imitation perceptible when two designs are closely scanned and accordingly an infringement. *Dunlop Rubber Co. v Golf Ball Development* [1931] 48 RPC 268 at p. 279 followed in *Castrol India v Tide Water Oil Co.* (1996) PTC 202(Cal) at p. 209**

不正な模倣とは、故意に登録意匠に基づいた模倣であると考えられ、明らかな模倣というほど明白ではない。つまり、登録意匠と不正意匠との違いはより微妙であり、いくつかの点で元の意匠と異なっており、それらの点によって、明らかな模倣とならなくても、2つの意匠を綿密に精査すれば模倣が認識される場合は模倣であり、侵害となる。*Dunlop Rubber Co. v Golf Ball Development* [1931] 48 RPC 268 at p. 279 followed in *Castrol India v Tide Water Oil Co.* (1996) PTC 202(Cal) at p. 209

- **Where therefore fraudulent imitation is established even if the imitation is rather clumsy and not obvious the court may take a serious view of it.**

したがって、模倣が稚拙で、裁判所が深刻視するほど明らかでなくても、不正な模倣は成立する。

- **One of the tests to find out the identity or sameness of the design is to find whether there are substantial differences between the design subsequently registered and the design which was earlier registered. These differences cannot be based on purely subjective or utilitarian or aesthetic considerations. The differences must be objective in its essential features.**

意匠の同一性を判断するテストの1つとして、先に登録された意匠と、後に登録された意匠との間に、実質的な相違があるかを判断する。この相違は、主観的、実用的または美的な考察に基づくものではなく、本質的な特徴における客観的な相違でなければならない。

- **For determining rights in relation to any design, the court has to first assess what are the features of the design which had been claimed in the description of the design.**

意匠に関する権利について決定する際、裁判所はまず、当該意匠の明細書でクレームされた意匠の特徴がどのようなものかを判断する必要がある。

- **For determining whether two designs are identical or not, it is not necessary that the two designs should be exactly the same. Identity on Each Point not Necessary. The main consideration to be applied is whether the broad features of shape, configuration, pattern etc. are same or nearly the same and if they are substantially the same, then it is the case of imitation of the design of one by the other *Alert India Ltd. v. Navin Plastic* 1997 (17) PTC 15 (del) and *Dabur India Ltd. v. Amit Jain* 2009 (39) PTC 104 (Del DB).**

2つの意匠が同じか否かを判断する際、必ずしも2つの意匠はまったく同じである必要はない。それぞれの点で同一である必要はない。最も重要な考慮事項は、形状、輪郭、模様などの大まかな特徴が、同じまたはほぼ同じであるか。実質的に同じであれば、一方が他方を模倣しているということになる。*Alert India Ltd. v. Navin Plastic* 1997 (17) PTC 15 (del) and *Dabur India Ltd. v. Amit Jain* 2009 (39) PTC 104 (Del DB)

- **The definition of the design lay emphasis on the fact that the sameness of the features is to be decided by the eye, that is by seeking the two and getting total synoptic view of the same. The sameness of features do not necessarily mean that the two designs must be identical on all points and differ on no point. *Falcon Tyres Limited v. TVS Srichakara Tyres Ltd.*, 2008 (3) MIPR 221.**

意匠の定義は、特徴の同一性は視覚によって決まること、つまり、2つのものを見て、両者の総観的見解を得ることによって決まることを重視している。特徴の同一性とは、必ずしも2つの意匠が、すべての点で同じで、違う点がまったくないことを意味するものではない (*Falcon Tyres Limited v. TVS Srichakara Tyres Ltd.*, 2008 (3) MIPR 221)

- **Where in the registration there is a statement of novelty and particular features claimed to be novel is specified, copying that particular feature or applying that with ordinary variations would constitute piracy. A design which does not incorporate claimed feature of novelty will not be held a contravention of the registered design, even though it might come quite close.**

登録において、新規性の陳述があり、新規であると主張する特徴が明記されている場合、その特徴を複製したり、通常の変更によって使用することは盗用になる。新規性の特徴を含まない意匠は、近似するものであっても、登録意匠の違反にはならない。

Question 6-2 Please explain in detail how the scope of design protection is affected by the identity or similarity of articles or by the identity or similarity of the functions and use of articles. Please give us any judicial precedent where the court presented its interpretation as to how the scope of design protection is affected by these factors.

Answer Section 6-2:

As per Indian Design Law, a design is registered for goods covered by a particular class [Section 6(1) of the Indian Design Act, 2000]. Although the design might be intended for and actually applied only to one particular article the protection extends to the articles covered by the whole class [Section 2(c) of the Indian Design Act, 2000 which defines copyright in design as exclusive right to apply a design to any article in any class in which the design is registered]. The monopoly conferred by a registered design extends to all articles covered in the class in which design is registered. It follows that design is not new or original for the purpose of registration in any class if it is old in its application to any article in that class. The judicial precedent on this point which is followed by Indian courts and Design Office is *Stenor v Whitesides* [1948] 65 RPC 1 at p. 16 (HL). Thus, design protection covers protection of the design applied to articles in the same class which may be identical or similar.

However, function and use of articles does not affect scope of the design protection.

インド意匠法によれば、意匠は所定の区分に含まれる物品に関して登録できる（2000年インド意匠法第6条(1)）。意匠が、特定の1つの物品のみを意図し、実際にその物品のみに使用されていても、保護は、その区分に含まれる物品全体に及ぶ（第2条(c)では、意匠権を「意匠が登録されている区分における物品に当該意匠を適用する排他的権利」と定義）。登録意匠によって与えられる独占権は、意匠が登録されている区分に含まれるすべての物品に及ぶ。すなわち、ある区分の物品に既に使用されている意匠は、その区分での登録に対する新規性や創作性がないと言える。この点について、裁判所および庁は、以下の判例を採用している：*Stenor v Whitesides* [1948] 65 RPC 1 at p. 16 (HL)。したがって意匠保護の効力は、同じ区分の同一または類似の物品に使用される意匠にも及ぶ。

ただし、物品の機能や用途は、意匠保護の範囲には影響しない。

Question 6-3 Please explain in detail how the scope of design protection is affected by the parts of an article that are not represented in drawings or photographs.

Answer Section 6-3:

As per Section 2(d) of the Indian Design Act, 2000, “design means only the features of shape, configuration, pattern, ornament or composition of colours etc..... “. If the part of an article is not represented in the drawings or photograph, the features of shape, configuration, pattern, ornament or composition of colours etc. are not visible, and therefore, scope of design protection cannot be determined in such cases. Indian Design Law does not extend protection to features not represented in the drawing or photographs.

2000年意匠法第2条(d)では、「意匠とは、形状、輪郭、模様、装飾もしくは色彩の構成の特徴に限られるものであって…」と定義している。図面または写真に表されていない箇所は、その形状、輪郭、模様、装飾、色彩の構成などが見えないため、意匠保護の範囲を決定することができない。インド意匠法では、図面や写真に表されていない特徴には効力は及ばない。

Question 6-4 In the case of a design right for an article which partially changes to perform its functions, does the scope for design protection cover the configurations observed in the course of change? Or, does the scope of design protection cover only the configuration before a change and the configuration after the change?

The following is a specific example where a part of an article (toy) that has a three-dimensional configuration changes its configuration to perform its functions.

[Front view]



[Rear view]

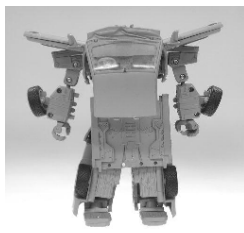

[Left side view]



[Right side view]

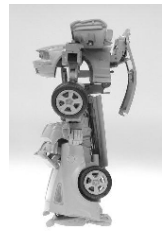

[Top view]



[Bottom view]



[Perspective view of the changing configuration]



[Front perspective view after the change]



[Rear perspective view after the change]



Answer Section 6-4:

Section 2(d) of Indian Design Act, 2000 design as “design” means only the features of shape, configuration, pattern, ornament or composition of lines or colours applied to any article whether in two dimensional or three dimensional or in both forms, by any industrial process or means, whether manual, mechanical or chemical, separate or combined, which in the finished article appeal to and are judged solely by the eye; but does not include any mode or principle of construction or anything which is in substance a mere mechanical device, and does not include any trade mark as defined in clause (v) of sub-section (1) of section 2 of the Trade and Merchandise Marks Act, 1958 or property mark as defined in section 479 of the Indian Penal Code or any artistic work as defined in clause (c) of section 2 of the Copyright Act, 1957. 2000年意匠法第2条(d)は次のように定義している：「意匠」とは、手工芸的、機械的、もしくは化学的の如何を問わず、または分離もしくは結合の如何を問わず、工業的方法または手段により、2次元もしくは3次元またはその双方の形態かを問わず、物品に適用される形状、輪郭、模様、装飾もしくは線または色彩の構成の特徴に限られるものであって、製品において視覚に訴え、かつ、視覚によってのみ判断されるものを意味する。ただし、構造の態様もしくは原理、または実質的に単なる機械装置であるものを含まず、1958年商標及び商品標法第2条(1)(v)において定義された商標、インド刑法第479条において定義された財産標章、または1957年著作権法第2条(c)において定義された芸術的作品も含まない。

Thus, as per the definition of the “design” under the Act, features of shape or configuration which are dictated solely by the function are not registrable. The scope of the design protection does not cover the configuration observed in the course of change as it constitute functional aspect of the design and prohibited from registration under the Indian Design Act, 2000.したがって、意匠法による「意匠」の定義によれば、機能のみによって決まる形状や輪郭の特徴は、登録可能でない。変化の過程における形態は、意匠の機能的な側面であり、2000年意匠法で登録が禁じられているため、意匠保護の効力は及ばない。

Question 6-5 This question is about the scope of design protection in the case of a set of articles or a certain set of articles. Does the design protection only cover a set of articles or a certain set articles? Or, does the design protection also cover each article that comprises a set?

If simultaneously used multiple articles are coordinated as a whole, the designs of those articles may be regarded as a single design. Such a design may be regarded as a "design for a set of articles." The term "a design for a certain set of articles" is conceptually the same as "a design for a set of articles." The term "a design for a certain set of articles" refers to a design used for any of the prescribed types of set.

Answer Section 6-5:

Rule 14(2) of the Design Rules provides if a design is to be applied to a set, the representation shall depict various arrangements in which the design is to be applied to articles in the set.

意匠規則 14(2)は、意匠を組物に使用しようとするときは、その表示には、当該意匠を当該組物の物品に使用しようとする各種取合せを示さなければならないと規定している。

Indian Design Law protection covers a set of articles. It does not cover only a certain set of articles. Further, design protection does not cover each article that comprises set.

インド意匠法による保護の範囲は、組物の物品に及ぶが、ある一定の物品のセットには及ばない。また、組物を構成する 1 つ 1 つの物品は意匠保護の対象ではない。

Question 6-6 This is a question about the restrictions on the exercise of design rights that are related to each other in conflict of which both right holders and both filing dates are deferent.

Design rights are considered to be related to each other in conflict in the following three cases:

- (i) a design right to protect the design of a whole article and a design right to protect the design of a component of the article (the component can be regarded as an independent article). Filing date of the design right of a component of the article is earlier than filing date of the design right of a whole article. Both rights are owned by deferent persons;
- (ii) a design right to protect the design of a whole article and a design right to protect the design of a part of the article (a part means a portion of the article and cannot be separated as a component). Filing date of the design right of a part of the article is earlier than filing date of the design right of a whole article. Both rights are owned by deferent persons; and
- (iii) a design right to protect the design of a set of articles or a certain set of articles and a design right to protect the design of any article that

comprises a set. Filing date of the design right of any article that comprises a set is earlier than filing date of the design right of a set of articles or a certain set of articles. Both rights are owned by deferent persons.

For example, in Case (i) above, if the holder of a design right to protect the design of a whole article works the design or exercises the design right, is it sometimes necessary for him/her to obtain a license from the holder of a design right to protect the design of a component? How about the situations in Case (ii) and Case (iii) described above in terms of the restrictions on the exercise of design rights?

Answer Section 6-6:

As per Indian Design Law, a part or component of an article can be registered as a separate design if it is capable of being made and sold separately.

インド意匠法によれば、物品を構成する一部であっても、個別に製造して販売できる場合は、個別の意匠として登録できる。

In case (i), component of the article can be regarded as an independent article which is capable of being made and sold separately, therefore capable of being registered separately as per Indian Design Law. In case (i), it is necessary for the holder of design right in the whole article to obtain license from the holder of design right in the component of the article if novel feature of the design of the whole article lies in the component of the article. However, if the whole article is having novel shape and configuration in its entirety, there is no need to obtain license from the holder of rights in the component.

(i)の場合、物品の構成部品は、個別に製造して販売できる単独の物品として扱えるため、インド意匠法に基づいて個別に登録できる。(i)では、物品全体の意匠の新規の特徴がその構成部品にある場合は、物品全体の意匠権者が、この構成部品の意匠権者からライセンス許諾を受ける必要がある。ただし、物品が全体として新規の形状や形態を有している場合は、構成部品の意匠権者からライセンスを受ける必要はない。

In case (ii), the part of the article cannot be separated from the whole article. Therefore, it is not eligible for registration as a separate design under Indian Design Law as it cannot be either made or sold separately. No separate design protection subsists in the part of the article. In this case, no need to obtain license for the holder of design right in the whole article from any person as no design protection is available to part of the article in such a case.

(ii)の場合、物品の部分を全体から切り離すことができない。したがって、個別に製造や販売ができないため、インド意匠法では、個別の意匠としての登録可能性を有していない。物品の一部には個別の意匠保護は存在しない。このケースでは、物品の部分に対する意匠保護は認められないため、物品全体の意匠権者がライセンス許諾を受ける必要はない。

In case (iii), the set of article as per the requirement of the Indian Design Law is required to have same have common design even though articles are different (same class) such as “Tea Set” , “Pen Set”, “Knife set” etc. If an article that forms part of a set of articles has earlier registration, then holder of right in set of articles or a certain set of article is required to have license from the holder of right in an article which forms part of a set of articles.

(iii)の場合、組物の物品は、インド意匠法の規定に従い、茶器セット、ペンセット、ナイフセットのように、物品は異なっても（区分は同じ）、同じ（共通の）意匠でなければならない。物品の一部を成す物品が先に登録されている場合、組物またはセット物の意匠権者は、組物の一部を成す物品の意匠権者からライセンス許諾を受ける必要がある。

Question 6-7 This is a question to the IP Office of any country that protects multiple images as a single design.

If your country does not protect multiple images as a single design, please skip this question and answer Question 7.

In the case of two related design rights, i.e., a design right to protect the designs of multiple images and a design right to protect the design of any of those images, are in conflict. Filing date of the design right of any of those images is earlier than filing date of the designs right of multiple images. Both rights are owned by deferent persons. In this case, are any restrictions imposed on the exercise of those design rights?

Answer Section 6-7:

Not Applicable

該当しない。

Question 6-8 This is a question to the IP Office of any country that protects multiple images as a single design and conducts substantive examination. If your country does not protect multiple images as a single design and does not conducts substantive examination, please skip this question and answer Question 7.

In case of a application seeking for a protection of a design of multiple images When filing date of a application seeking for a protection of design of any those images is earlier than filing date of a application seeking for a protection of a design of multiple images, and both applicants are different, what measures do you take when determining whether such a design has novelty and is not easily creatable by any person skilled in the art?

Answer Section 6-8:

Not Applicable

該当しない。

Question 7 Disclosure by drawings included in application documents and publication by gazettes

Question 7-1 Are there any cases where a drawing or photograph included in application documents is edited (e.g., altered in size or ratio) when the design is publicized in a design gazette (including an electronic gazette)? If editing is conducted, please tell us the reasons and standards for editing.

Answer Section 7-1:

Drawing or photograph of the design are reduced in size for publication of the registered designs in the Official Journal of the Patent Office which is also published electronically. However, in views of the design which are supplied with the physical certificate of the registration of design, there is no editing in terms of size or ratio of the drawings or photographs.

特許庁の Official Journal（電子的にも公開される）に登録意匠を掲載するため、意匠の図面または写真のサイズが縮小される。しかし、意匠登録証とともに提供される意匠の図は、サイズや比率の変更といった加工は行わない。

Question 7-2 If a design application is filed by an electronic medium, do you store printed-out hardcopies of the representations of the design as the original documents in addition to the submitted electronic images of those representations? If yes, why?

Answer Section 7-2:

In India, design applications are not yet filed electronically. The process to make electronic filing available to the Applicant is in the progress. At present, only hard copy of the application and other documents is filed in the Design Office. Therefore, attorneys in India keep hard copies of the design application and other documents.

インドでは電子出願はまだ行われていない。出願人が電子出願を利用できるようにするためのプロセスは進行中である。現時点では、出願やその他の書類のハードコピーのみが、庁へ提出される。したがって、インドの代理人は、意匠出願およびその他の書類のハードコピーのみを保管している。

Question 7-3 Does the public have access to the documents (including electronic data) prepared in the course of design prosecution starting from the filing of a design application to the registration of the design? If yes, please tell us the inspection fee and conditions (to what extent is inspection permitted? Are there any documents that are not available for inspection?).

Answer Section 7-3:

Public has access to electronic database in the form Official Journal of the Patent Office in which designs registered in India are published on the weekly basis. Official Journal of the Patent Office provides information such as following matters on designs:

インドで登録された意匠を週単位で公開する特許庁の Official Journal の電子データベースを閲覧することができる。Official Journal には、意匠に関する以下のような情報が記載される。

- a. Public notice, if any.
- b. Registered designs.
 - i. Registration number.
 - ii. Date of filing.
 - iii. Name of article.
 - iv. Class of the article.
 - v. Name and address of the registered proprietor.
 - vi. Priority details like priority date and country.
 - vii. Best view(s) of the article from the representation.
- c. Renewal of designs (only registration number).
- d. Restored Designs.
- e. Assignments / licenses/ Mortgage registration.
- f. Matters relating to rectification.
- g. Matters relating to cancellation.

- a. 公告（ある場合）
- b. 登録された意匠
 - i. 登録番号
 - ii. 出願日
 - iii. 物品の名称
 - iv. 物品の区分
 - v. 登録意匠権者の名前および住所
 - vi. 優先権に関する優先日、指定国などの詳細
 - vii. 物品の表現の最適な図（Best View）
- c. 意匠の更新（登録番号のみ）

- d. 回復された意匠
- e. 譲渡／実施権／抵当権の登録
- f. 修正に関する事項
- g. 取消に関する事項

The Patent Office Journal is available in the physical form.

Further, there is also online database known as “Indian Design Application Information Retrieval System” for pending design Application and the registered design which can be accessed by entering application no. and registration number of design. This online database simply provides bibliographic information such as date of filing, name of the applicant, name of article, date of official action if issued, place of filing the application, and application status whether registered or pending etc.

Official Journal は紙ベースで提供される。

また、「インド意匠出願情報検索システム」というオンライン・データベースもあり、係属中の意匠出願や登録出願を、出願番号または登録番号を入力して検索できる。このデータベースでは、出願日、出願人の名前、物品の名称、オフィスアクションが出された場合はその日付、出願の提出場所、登録済／係属中のような出願の状態など、文献情報のみが提供される。

Apart from using online database, Request for inspection as per Section 17 of the Indian Designs Act, 2000 can be filed on Form-5 during the existence of the copyright in the design with prescribed official fee to obtain information about a registered design. The official fee for inspection is Rs. 500/- (or US\$ 10/-). In such an inspection, one may have access to documents filed during the prosecution of the design application apart from official action and decision given by the Examiner/Controller.

オンライン・データベースの他に、意匠法第 17 条に基づき、意匠権の存続期間中、所定の手数料を納付の上で、登録意匠に関する情報を得るための閲覧請求を書式 5 で提出することができる。閲覧手数料は、500 ルピー（10 米ドル）である。この閲覧では、審査官／長官によるオフィスアクションや決定の他にも、意匠出願の権利化手続において提出された書類にアクセスできる。

Where an application for a design has been abandoned or refused, any document related to such application is not open to public inspection.

The register of designs maintained at Patent Office, Kolkata is open to inspection on payment of required fee.

Inspection shall be allowed by the Controller as far as possible on the same day, if the applicant is present. If the request is received by post, an earliest date for inspection may be fixed and communicated to the Applicant/Attorney.

放棄または拒絶された意匠出願については、関連する書類は閲覧のために公開されない。

コルカタの特許庁で管理されている意匠登録簿は、所定の手数料を納入すれば閲覧できる。閲覧は、出願人が出頭した場合は、長官によって可能な限り同日に認められる。申請が郵送で受理された場合は、できるだけ早い閲覧日が決められ、出願人／代理人へ通知される。

Further, all the documents including documents filed during the prosecution of the design application, official action issued by the Design Office, orders passed by the Examiner/Controller may be obtained by filing request for information (RTI) under Right to Information Act, 2005 on payment of nominal fee.

また、意匠出願の権利化手続において提出された書類、庁によるオフィスアクション、審査官／調査官が出した命令などを含むすべての書類は、2005年情報権利法に基づき、わずかな手数料を納付し、情報請求書（RTI）を提出することで入手できる。

Question 8 Do you receive any opinions from users of the design system such as a request for a revision of the design system in order to change the way of representing a design in a design application under the relevant laws, regulations, and examination guidelines of your country and to remedy the current situation where the way of representing a design differs from one country to another? If yes, please describe those opinions in detail.

Answer Section 8:

The Applicants for design application often ask question regarding deletion of the dotted or broken lines as per the requirement of the Examiner/Controller in the Design Office. Please note Manual of Design practice and procedure states that dotted lines may be used in representation to indicate those elements of the article for which no protection is sought. Dotted lines identify elements which are not part of the claimed design. However, the Examiner/Controller generally objects to dotted lines at the time of the issuance of the Examination Report and ask for removal of the dotted lines from the drawings. The Examiner/Controller ask for deletion of the dotted lines because Examiner/Controller believes dotted lines along with solid lines may indicate that the protection is being sought for “part of an article” which is not allowed under Indian Design Act, 2000. Users of the design system in India often opine that there is a need to allow such dotted lines to better represent novel feature of the article for which design protection is required.

意匠出願の出願人から、審査官／長官が点線または破線の削除を要求することについて質問を受けることが多い。意匠運用手順マニュアルには、意匠の表示において、保護を求めない物品の要素を示すために点線を使用してよいと書かれている。点線は、出願した意匠の一部ではない要素を識別するものである。しかし、審査官／長官による審査レポートでは通常、点線は拒絶理由とされ、図面から削除するよう求められる。これは、

実線とともに点線を使用することで、2000年意匠法で認められない「物品の一部」に対する保護を求めているものと、審査官／長官が解釈するためである。意匠制度のユーザーからは、意匠保護が必要な物品の新規の特徴を、より正確に表示するために点線を認める必要があるという意見が多い。

Question 9 In recent years, has the number of design applications been on the rise or on the decline? What do you think has caused such increase or decrease?

Answer Section 9:

In recent years, there has been an increase in number of design application in India except the year 2008-09 to 2009-10 when there was a slight dip in the filing of the design application. As per Annual Report 2010-11 of The Office Of The Controller General Of Patents, Designs, Trade Marks And Geographical Indication, there has been an 24.57% increase in filing of design application for the period 2009-10 to 2010-11.

インドでは近年、意匠出願件数は増加傾向にあるが、2008～09年と2009～10年の間はわずかに減少している。特許意匠商標総局2010-11年次レポートによれば、2009～10年と2010～11年の間では、意匠出願件数は24.57%増加している。

The reason for increase in the filing of the design application is the simplification of the process for the registration of the design under the new The Design Act, 2000 and Design Rules, 2011 [as amended in 2008]. Further, there have been many administrative changes which made registration of the design quicker and less expensive. Finally, there have been more awareness about the protection of the design in India and now there is better enforcement of rights of the proprietor of the design in the court of law. As a result of the awareness about the protection of design, almost 75% of the design application in India has been filed by Indian Applicants.

意匠出願件数が増加した理由は、新たな2000年意匠法および2001年意匠規則（2008年に改正）に基づいて、意匠登録プロセスが簡素化されたことが挙げられる。また、さまざまな行政手続の変更により、意匠登録が迅速化され金銭負担が軽減されたことも挙げられる。さらには、インドにおいて意匠保護に対する意識が高まり、裁判所における意匠権者の権利行使もしやすくなった。意匠保護に対する意識が高まった結果、意匠出願の約75%がインド人の出願人によるものになった。

Question 10 If your country has signed the Hague agreement, please answer this question. Did the number of design applications increase or decrease in your country before and after the signing of the Hague agreement?

Answer Section 10

India has not signed the Hague Agreement nor there is any proposal to sign Hague Agreement.

インドはヘーグ協定に調印しておらず、調印する計画もない。

Question 11 If your country has signed the Hague agreement, please skip this question and answer Question 12.

This is a question to the IP Office of any country that is planning to sign the Hague agreement. What are your purposes for signing the Hague agreement? Please describe your purposes in detail.

Answer Section 11

India has not signed the Hague Agreement nor there is any proposal to sign Hague Agreement.

インドはヘーグ協定に調印しておらず、調印する計画もない。

Question 12 Please answer this question if your country has signed the Hague agreement or is planning to do so. In order to sign the Hague agreement, did you have to make any alterations or adjustments to your country's system? Or, is your country planning to alter or adjust your country's system in the future?

Answer Section 12

India has not signed the Hague Agreement nor there is any proposal to sign Hague Agreement.

インドはヘーグ協定に調印しておらず、調印する計画もない。

[Request for information]

- 13** If your country has adopted a multiple design application system, please send us information on how an application and drawings should be prepared in order to file a multiple design application. We would appreciate if you could send us a sample application and a sample drawing that are available for disclosure (those with all the sections filled in with information as a sample). If such application and drawing are not available for disclosure, please send us a blank application form, etc., if possible.

Answer: In India, we do not have multiple design application system.

インドには、複数意匠一括出願の制度はない。

- 14** Is it possible for you to send us a sample registration certificate? Again, we would appreciate if you could send us such a certificate with all the sections filled in with information as a sample. If such certificate is not available for disclosure, please send us a blank certificate form, if possible.

Answer: Please find attached original certificate of the registration of the design as issued by the Indian Design Office in one of the design application prosecuted by us on behalf of the Applicant.

出願人の代理として当方で行った意匠出願の 1 つに対して、インド特許庁から交付された意匠登録証のオリジナルを添付した。

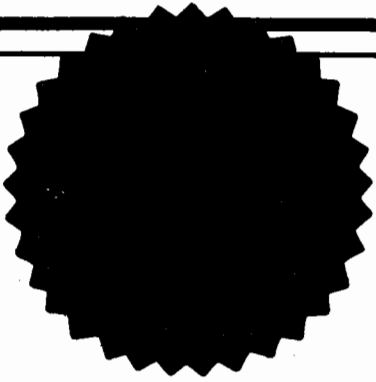

सत्यमेव जयते

ORIGINAL

No. **19127**

**GOVERNMENT OF INDIA
THE PATENT OFFICE
CERTIFICATE OF REGISTRATION OF DESIGN**

Design No.	234184
Date	01/02/2011
Reciprocity Date*	04/08/2010
Country	JAPAN

Certified that the design of which a copy is annexed hereto has been registered as of the number and date given above in class 12-15 in respect of the application of such design to TIRE in the name of SUMITOMO RUBBER INDUSTRIES LTD. A COMPANY ORGANIZED UNDER THE LAWS OF JAPAN OF THE ADDRESS; 6-9, WAKINOHAMA-CHO 3-CHOME, CHUO-KU, KOBE-SHI, HYOGO 651-0072, JAPAN

in pursuance of and subject to the provisions of the Designs Act, 2000 and the Designs Rules, 2001.

Controller General of Patents, Designs and Trade Marks

*The reciprocity date (if any) which has been allowed and the name of the country.
Copyright in the design will subsist for ten years from the date of Registration, and may under the terms of the Act and Rules, be extended for a further period of five years.
This Certificate is not for use in legal proceedings or for obtaining registration abroad

SHARAD VADEHRA,
KAN AND KRISHME., B-483, KNK HOUSE, MEERA
BAGH, PASCHIM VIHAR, NEW DELHI-110 063, INDIA

Date of Issue 01/11/2012 16:45:42

SUMITOMO RUBBER INDUSTRIES, LTD.

Total Sheets: Seven
Sheet No.: 1

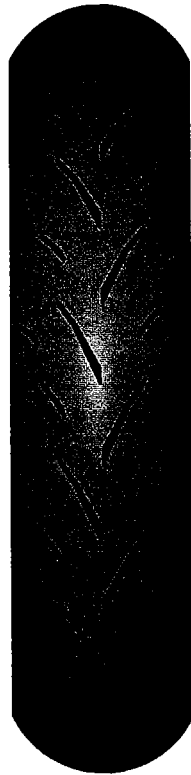

FRONT VIEW

Dated this 01st day of February 2011



SHARAD VADEHRA
of KAN AND KRISHME
AGENT FOR THE APPLICANTS

234184

01 FEB 2011

The novelty resides in the shape and configuration of "Tire"
as illustrated.

No claim is made by virtue of this registration in respect of
any Mechanical or other action of the mechanism whatsoever
or in respect of any mode or principle of construction of this
article.

No claim is being made to the colour or colour combination or
use of words, letters, number or Trademarks appearing in the
Design.

Dated this 01st day of February 2011



(SHARAD VADEHRA)
of KAN AND KRISHME
Attorney for the Applicants

SUMITOMO RUBBER INDUSTRIES, LTD.

Total Sheets: Seven
Sheet No.: 2

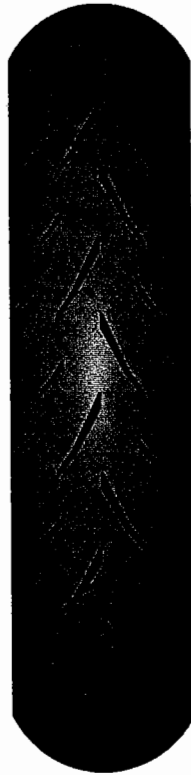

REAR VIEW

Dated this 01st day of February 2011



SHARAD VADEHRA
of KAN AND KRISHME
AGENT FOR THE APPLICANTS

234184

01 FEB 2011

The novelty resides in the shape and configuration of "Tire"
as illustrated.

No claim is made by virtue of this registration in respect of
any Mechanical or other action of the mechanism whatsoever
or in respect of any mode or principle of construction of this
article.

No claim is being made to the colour or colour combination or
use of words, letters, number or Trademarks appearing in the
Design.

Dated this 01st day of February 2011



(SHARAD VADEHRA)
of KAN AND KRISHME
Attorney for the Applicants

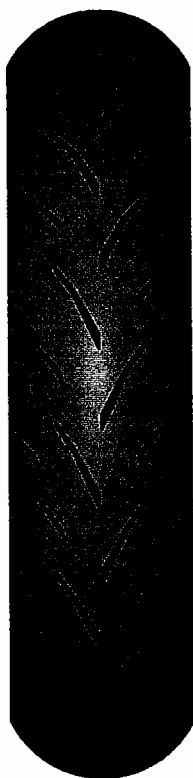

TOP VIEW

Dated this 01st day of February 2011



SHARAD VADEHRA
of KAN AND KRISHME
AGENT FOR THE APPLICANTS

234184

01 FEB 2011

The novelty resides in the shape and configuration of "Tire"
as illustrated.

No claim is made by virtue of this registration in respect of
any Mechanical or other action of the mechanism whatsoever
or in respect of any mode or principle of construction of this
article.

No claim is being made to the colour or colour combination or
use of words, letters, number or Trademarks appearing in the
Design.

Dated this 01st day of February 2011



(SHARAD VADEHRA)
of KAN AND KRISHME
Attorney for the Applicants

SUMITOMO RUBBER INDUSTRIES, LTD.

Total Sheets: Seven
Sheet No.: 4

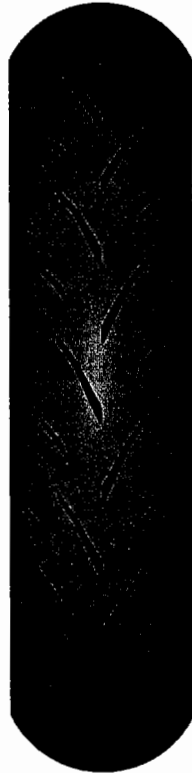

BOTTOM VIEW

Dated this 01st day of February 2011

SHARAD VADEHRA
of KAN AND KRISHME
AGENT FOR THE APPLICANTS

234184

01 FEB 2011

The novelty resides in the shape and configuration of "Tire"
as illustrated.

No claim is made by virtue of this registration in respect of
any Mechanical or other action of the mechanism whatsoever
or in respect of any mode or principle of construction of this
article.

No claim is being made to the colour or colour combination or
use of words, letters, number or Trademarks appearing in the
Design.

Dated this 01st day of February 2011



(SHARAD VADEHRA)
of KAN AND KRISHME
Attorney for the Applicants

SUMITOMO RUBBER INDUSTRIES, LTD.

Total Sheets: Seven
Sheet No.: 5

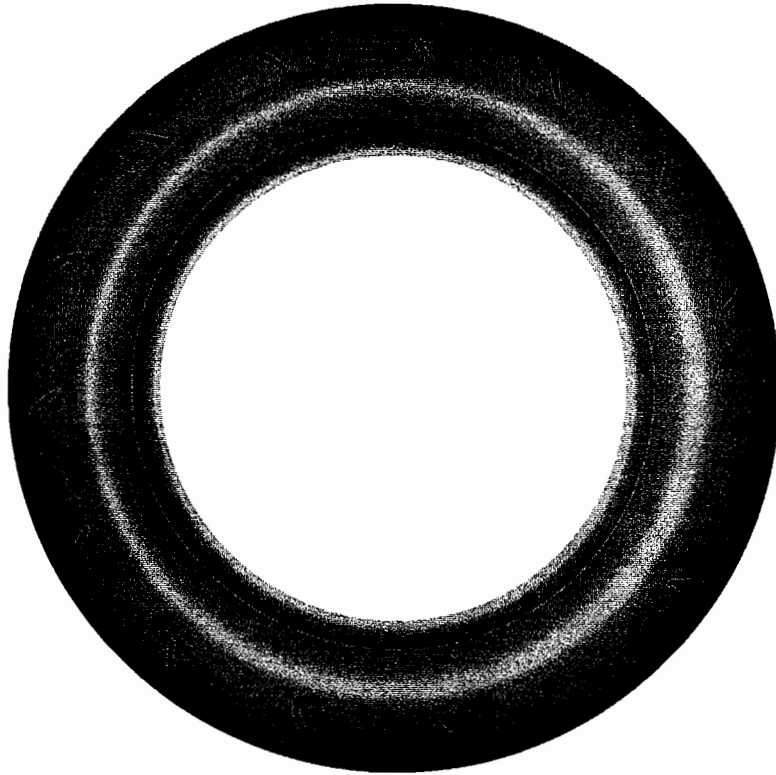

RIGHT SIDE VIEW

Dated this 01st day of February 2011

SHARAD VADEHRA
of KAN AND KRISHME
AGENT FOR THE APPLICANTS

234184

01 FEB 2011

The novelty resides in the shape and configuration of "Tire"
as illustrated.

No claim is made by virtue of this registration in respect of
any Mechanical or other action of the mechanism whatsoever
or in respect of any mode or principle of construction of this
article.

No claim is being made to the colour or colour combination or
use of words, letters, number or Trademarks appearing in the
Design.

Dated this 01st day of February 2011



(SHARAD VADEHRA)
of KAN AND KRISHME
Attorney for the Applicants

SUMITOMO RUBBER INDUSTRIES, LTD.

Total Sheets: Seven
Sheet No.: 6

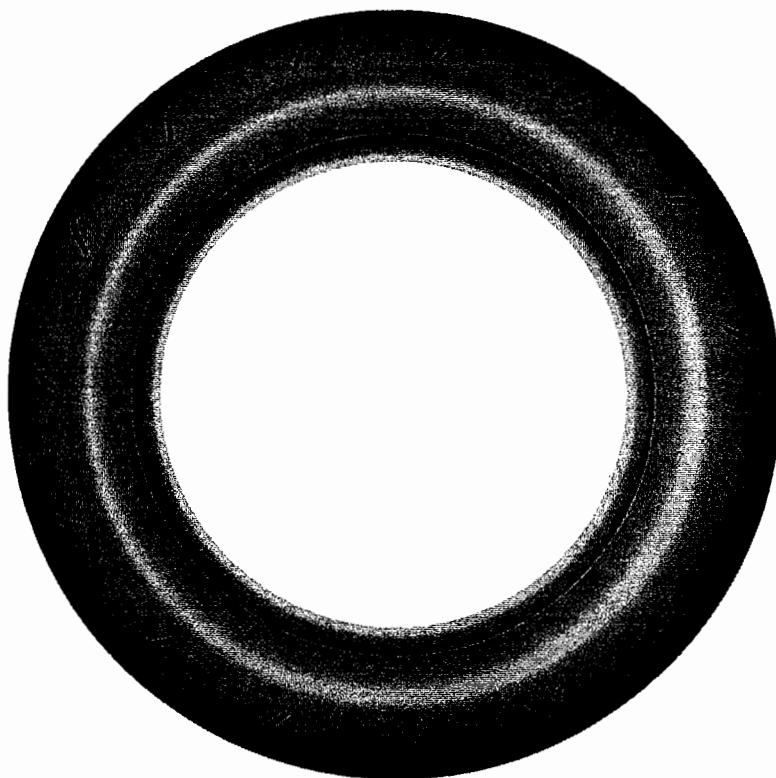

LEFT SIDE VIEW

Dated this 01st day of February 2011



SHARAD VADEHRA
of KAN AND KRISHME

AGENT FOR THE APPLICANTS

234184

01 FEB 2011

The novelty resides in the shape and configuration of "Tire"
as illustrated.

No claim is made by virtue of this registration in respect of
any Mechanical or other action of the mechanism whatsoever
or in respect of any mode or principle of construction of this
article.

No claim is being made to the colour or colour combination or
use of words, letters, number or Trademarks appearing in the
Design.

Dated this 01st day of February 2011



(SHARAD VADEHRA)
of KAN AND KRISHME
Attorney for the Applicants

SUMITOMO RUBBER INDUSTRIES, LTD.

Total Sheets: Seven
Sheet No.: 7

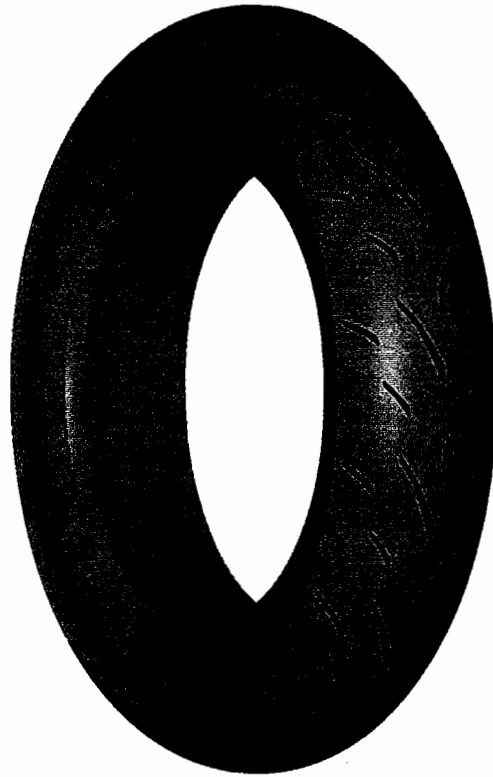

PERSPECTIVE VIEW

Dated this 01st day of February 2011

SHARAD VADEHRA
of KAN AND KRISHME
AGENT FOR THE APPLICANTS

234184

01 FEB 2011

The novelty resides in the shape and configuration of "Tire"
as illustrated.

No claim is made by virtue of this registration in respect of
any Mechanical or other action of the mechanism whatsoever
or in respect of any mode or principle of construction of this
article.

No claim is being made to the colour or colour combination or
use of words, letters, number or Trademarks appearing in the
Design.

Dated this 01st day of February 2011



(SHARAD VADEHRA)
of KAN AND KRISHME
Attorney for the Applicants

Interview Survey on IP Offices Concerning Representations of Designs

Name of the Country: Brazil

Time and Date of Visit (or Telephone conference): November 6, 2012 – 10.00 AM

Visited IP Office INPI :

Name of the Person Representing the IP Office (Please write if possible): Frederico Carlos da Cunha - Head of the Design Division of INPI)

Names of the Visitor and the Firm: Antonio Carlos Ramos, Partner of Kasznar Leonardos.

Question 1 Basic principle concerning representations of designs

Question 1-1 In the laws, regulations, examination guidelines, etc., of your country, there are provisions concerning the disclosure of designs. What is the underlying principle behind those provisions that determines the extent of disclosure of designs? In other words, when determining the extent of disclosure of designs, what are the primary goals of your country?

Example answers are listed below. Please give us a detailed answer.

- To facilitate formality examination or substantive examination.
- To facilitate storage of the submitted representations (drawings, photographs, specimens, etc.).
- To reduce the burdens on the users of the design system.
- To facilitate understanding of third parties (those other than design applicants and design holders)
- To facilitate the enforcement of rights.
- To ask for self-responsibility of the applicant who discloses his/her design.

Answer Section 1-1

All the reasons listed above can be mentioned as provisions for representing designs. Basically the primary goal is to have in each design a sole object (with its variants) represented by clear illustrations and which has the novelty character.

上述されたすべての理由は、意匠の表現に関する規定として挙げる事ができる。基本的に主要な目的は、意匠ごとに、明確な図で表現され、新規の特徴を備えた対象物が一つのみであること（およびその変形例）である。

Question 1-2 In many cases, designers design industrial products by using 3D CAD and CG software. Does your country allow design applicants to use the 3D CG images created in the stage of product design such as those shown below as design representations to be included in design application documents?

[Article which constitutes the Design] Attachable wash-basin
 [International Design Classification] 23-02
 [Description of the Article which constitutes the Design] This design will be used mostly by medical staff to wash their hands in medical facilities, etc.
 [Description of the Design] Each drawing was created using computer graphics software. The shading applied to the entire surface of the 3D configuration presented in each drawing shows the shape of the curved surface.

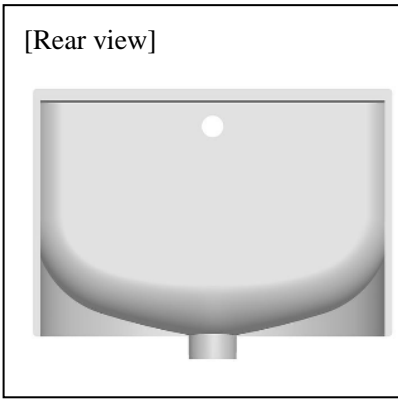
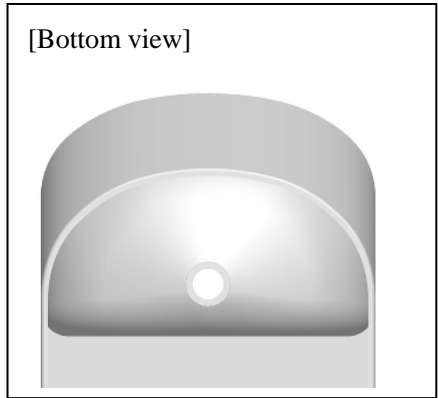
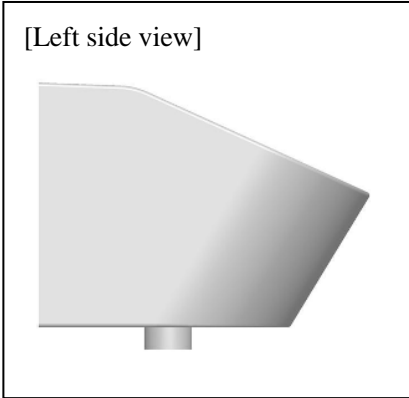
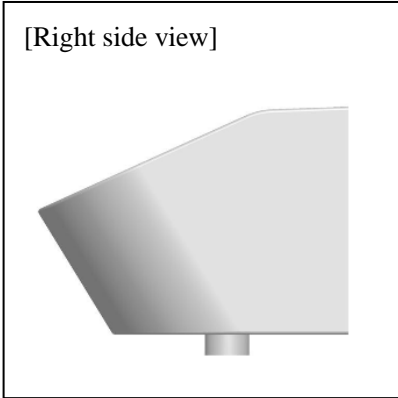
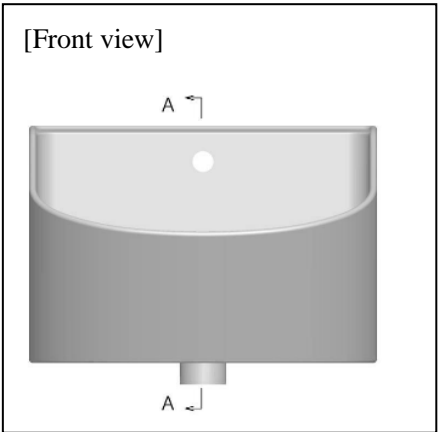
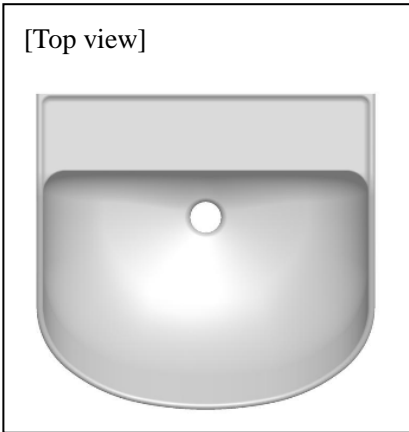
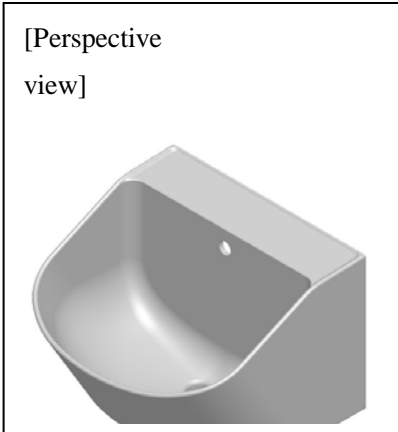

Answer Section 1-2

The Patent Office accepts the representations of an object independently if it is only a virtual object.

コンピュータ・グラフィックのみであるかどうかに関係なく、対象物の表現は認められる。

Question 2 Representations of designs under the system to protect the design of a part of an article (partial design system)

Question 2-1 This is a question to the IP Office of any country that has either a partial design system or a system to protect the design of a part of an article. If you are representing the IP Office of any country that has neither of these systems, please skip this question and answer Question 2-2.

Two specific examples of representations of partial designs are given below. In the case of Example 1, an applicant seeking protection for a partial design used a different color to distinguish the partial design from the rest of the article. In the case of Example 2, an applicant seeking protection for a partial design used a different line (broken line) to distinguish the partial design from the rest of the article. Does your country allow such representations of partial designs? Please tell us whether and why each of the following two methods shown in the following examples is permitted or not?

(Example 1) A case where an applicant seeking protection for a partial design used a different color to distinguish the partial design from the rest of the article

[Article which constitutes the Design] Passenger car
[International Design Classification] 12-08
[Description of the Design] The applicant is seeking registration of the partial design of the part other than the pink part shown in the drawings. The bottom view is omitted because this is a heavy article. The shading applied to the entire surface of the 3D configuration presented in each drawing shows the shape of the curved surface.

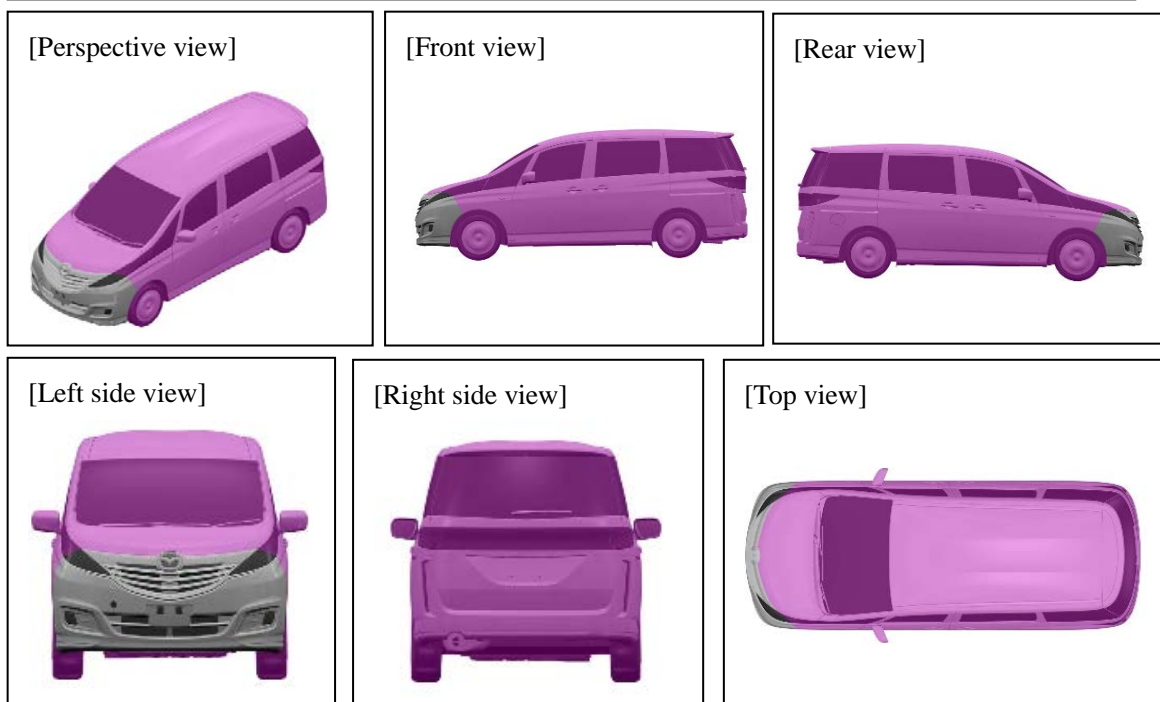

(Example 2) A case where an applicant seeking protection for a partial design used a different line to distinguish the partial design from the rest of the article

[Article which constitutes the Design] Packaging container
[International Design Classification] 09-01, 09-02, 09-03, 09-04, 09-05, 28-01
[Description of the Design] The part drawn by a solid line shows the part for which the applicant is seeking registration as a partial design.
The rear view is symmetrical to the front view
The bottom view is the same as the top view.
The enlarged rear view of the cap is symmetrical to the enlarged front view.
The enlarged bottom view of the cap is symmetrical to the enlarged top view.

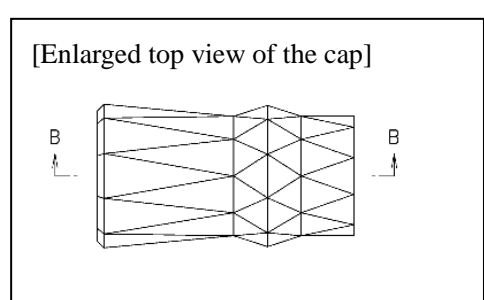
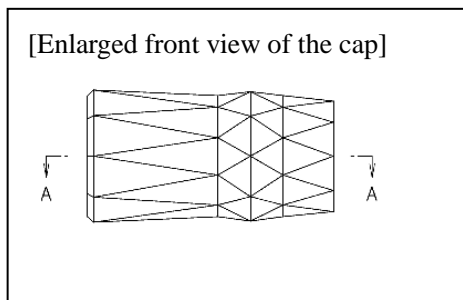
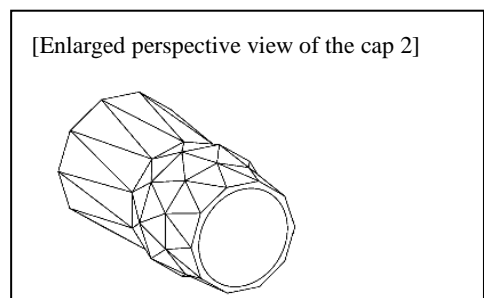
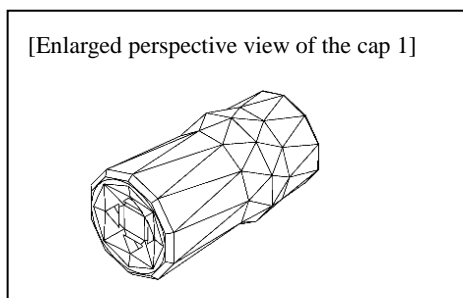
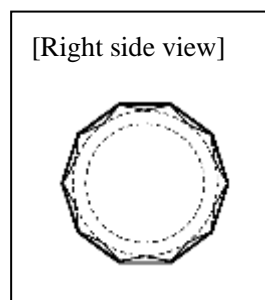
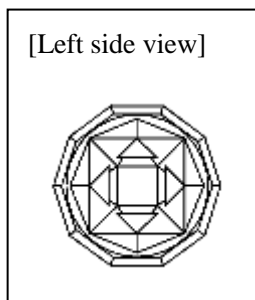

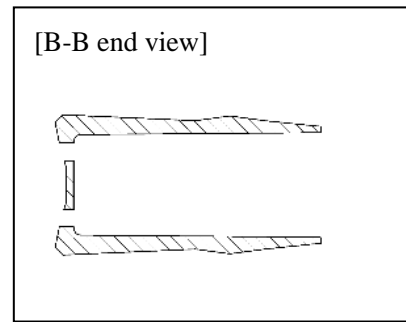
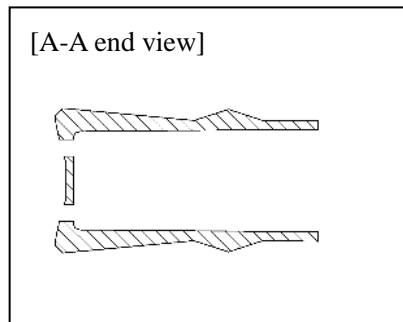
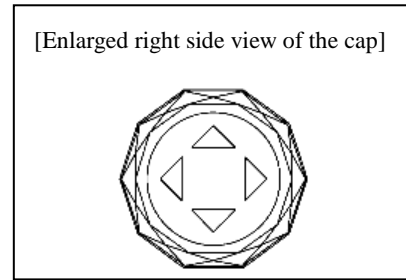
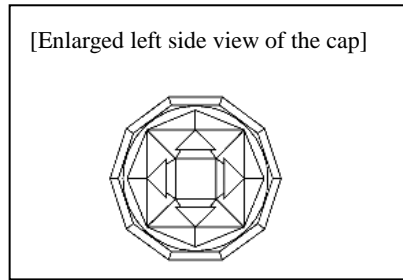

Japan Design Registration No. 1449069

Answer Section 2-1

Brazil does not accept partial designs. The design can be directed to a part or component provided that it is able to be manufactured separately.

ブラジルでは部分意匠制度は採用されていない。部品または単独で製造可能な構成要素が意匠の対象とされる。

Question 2-2 This is a question to the IP Office of any country that has neither a partial design system nor a system to protect the design of a part of an article. If you are representing the IP Office of any country that has either of these systems, please skip this question and answer Question 3.

Do the users of the design system of your country request protection for the partial designs of articles? For example, is there a need for the establishment of a partial design system, which is an effective countermeasure against infringers of partial designs who copy only a unique and innovative part of an article without copying the design of the article as a whole?

Answer Section 2-2

It is not usual to receive this sort of questions from the Applicants.

出願人からこの種の質問を受けることは、通常はない。

Question 3 The policy of conducting to find designs

Please answer this question regardless of whether your country has adopted a system that conducts only formality examination before registration, a system that conducts both formality examination and substantive examination before registration, or a system that conducts formality examination on all applications and conducts substantive examination only on certain applications before registration.

Question 3-1 In the course of formality examination on the design claimed in an application, to what extent do you conduct to find the design? Example answers are listed below. Please give us a detailed answer.

- We examine whether an application satisfies the prescribed formality requirements such as the number, sizes, etc., of the submitted drawings or photographs but do not examine the design in further detail.
- In addition to whether a design satisfies the formality requirements, we conduct to find out whether the design is disclosed in accordance with the relevant regulations by taking into consideration the article that embodies the design and checking the drawings, photographs, etc., submitted by the applicant.
- If we conduct to find design and determine that the design fails to satisfy the substantive requirements for design registration (e.g., the case where the design clearly lacks novelty), we conduct substantive examination as well

Answer Section 3- 1

In fact in Brazil there is not substantive examination called here merit examination unless requested by the Applicant or third parties.

実際のところブラジルでは、出願人または第三者から請求されない限り、実体審査（わが国では **merit examination** という）は行われない。

Question 3-2 Who conducts the formality examination mentioned in Question 3-1? Is it conducted by a formality examiner, Office staff member, or any other staff member (including a substantive examiner)? Please specify.

Answer Section 3-2

The formality examination is conducted by the formality staff, before reaching the Industrial Design. This formality examination concerns only the validity of documents, the presence of all requested documents, etc. A second examination to see for example if the figures are within the standards issued by the Patent Office is made in the Industrial Design division.

方式審査は、意匠部へ送られる前に、方式審査スタッフが行う。方式審査は書類の有効性、必要な書類がすべてそろっているかのみを審査する。続いて、意匠部において、例えば、各数値が特許庁の定めた基準内におさまっているかどうかなどが審査される。

Question 3-3 Do you have a system to invalidate a registered design right on the grounds that the design is unclear for such reasons as the design right having an unidentifiable scope? Example answers are listed below. Please give us a detailed answer.

- System to file a request with the IP Office for commencement of examination
- System to file a request with the IP Office for an invalidation trial
- System to file a lawsuit with a court

Answer Section 3-3

Question 3-4 Is there any judicial precedent where the clarity of a design representation was at issue? If yes, please summarize the judgment and tell us the grounds on which the court found the design representation to be unclear.

Answer Section 3-4

We are not aware of an judicial matter involving clarity of a design
意匠の明確性が裁判の争点になったことはないと認識している。

Question 4 Principle concerning amendments

Question 4-1 Is it permitted to amend a design application? If yes, what restrictions are imposed on an amendment in terms of time schedule and content? Please tell us any restrictions imposed on an amendment in practice other than those specified in the laws, regulations, examination guidelines, etc., that we should know about. Furthermore, is it permitted to make a voluntary amendment?

Answer Section 4-1

In fact it is not permitted to amend a design application although in some case it is possible to present amended pages or drawings/photographs sheets to correct obvious errors such as missing portions, spelling mistakes etc. Amendments are possible issuing from an Examiner manifestation.

実際には意匠出願の補正は認められないが、明らかな欠落やスペルミスなどの間違いを正すため、修正したページや図面／写真を提出できる場合もある。補正は、審査官が表明した場合に可能となる。

Question 4-2 What may be submitted to make an amendment? Please tell us what may be submitted in practice other than those specified in the laws, regulations, examination guidelines, etc.

Answer Section 4-2

The amendments are permitted according to Answer Section 4-1

質問 4-1 のような補正が認められる。

Question 4-3 If the IP Office refuses to accept any amendment made in response to an amendment order or made voluntarily, what action would the IP Office take? Is there a possibility that the IP Office dismisses the design application? Or, if only a minor defect is involved, would the IP Office accept amendment and register the application which was amended?

Answer Section 4-3

Question 4-4 Even though a design application is satisfied the formality requirements, are there any cases where the IP Office sends the applicant a instruction for an amendment related to a representation of the design in order to facilitate to conduct finding the design or to make the representation of the design more accurate? Please tell us what is stated in such a request in detail.

Answer Section 4-4

Yes, it is possible that an Examiner issues an Official Action requiring correction of some aspect in the specification or drawings.

ある。審査官がオフィスアクションによって、明細書または図面について何らかの修正を要求することはあり得る。

Question 4-5 In the case mentioned in Question 4-4, if the IP Office sends an instruction to an applicant, is the applicant required to make an amendment strictly in accordance with the instruction? Or, is the applicant permitted to make an amendment in the way he/she wishes to a certain extent? Please explain in detail.

Answer Section 4-5

The Applicant can naturally argue for correction to be made in a way a bit different from what the examiner required, but it is necessary to expect goodwill from the examiner. Usually, it is advisable to act as the Patent Office instruction.

出願人が、審査官の要求とやや異なる形での修正を主張できるのは当然だが、審査官の善意を期待する必要がある。通常は、特許庁の指示どおりにするのが望ましい。

Question 4-6 Is it permitted for a design applicant to divide the application and file a divisional application as a new design application? If we yes, what restrictions are imposed on the filing of a divisional application in terms of time schedule and content? Please tell us any restrictions imposed in practice other than those specified in the laws, regulations, examination guidelines, etc., that we should know about. For instance, is it permitted to divide a design application for a whole article and file a divisional design application for a new part or component?

7.1. When the Industrial Design application does not fulfill the requisites of Article 104, the filing applicant shall be notified and advised to split the application, within 60 (sixty) days of the notification, otherwise subject to definitive shelving thereof.

意匠出願が第 104 条の必要条件を満たしていない場合は、出願人に通知して、当該通知から 60 日以内に出願を分割するよう助言し、さもなければ拒絶処分となることを伝える。

7.1.1. The filing of the split application should include:

分割出願の提出には以下のものが含まれる。

- (I) **A petition, in accordance with Form Model 1.06;**
様式 1.06 による申立
- (II) **A specification, if applicable, in accordance with the provisions of the present Act;**
該当する場合は、本法の規定に基づく明細書
- (III) **Claims, if applicable, in accordance with the provisions of the present Act;**
該当する場合は、本法の規定に基づくクレーム
- (IV) **Drawings or photographs, in accordance with the provisions of the present Act;**
本法の規定に基づく図面または写真
- (V) **Field of Application of the Object, if applicable, in accordance with the provisions of this Act;**
該当する場合は、本法の規定に基づく対象物の使用分野
- (VI) **Evidence of payment of the applicable fees of the original application (in the amount indicated in the table of fees in force at the date of presentation thereof).**
原出願の出願手数料（提出日において有効な料金表に示された金額）納付の証拠

7.1.2. The documents that integrate the split application should be in accordance with the rules established in this Act. The indication to the fact that the application is split with mention of the number and filing date of the original application, in the following terms: “Divisional Application of Industrial Design _____, filed on __/__/__”, should be included in the specification and in field number 2 of the filing form immediately after the title (until a new form is established).

分割出願を統合する書類は、本法で定める規則に基づくものとする。出願が分割されたことは、原出願の番号と出願日によって、

「意匠 _____、出願日 __/__/__ の分割出願」のように示し、明細書および提出様式のタイトルの次にある欄（新たな様式が定められるまで）に記載する。

7.1.3. The drawings or photographs, the specification and the set of claims of the original

application, if applicable, should be altered accordingly, in order to exclude inconsistent matter or matter that is not clearly related to the object claimed in each application.

原出願の図面、写真、明細書およびクレームは、必要に応じて修正し、各出願で権利主張する対象物と明確な関係のない事項や矛盾する事項を削除する。

7.1.4. Each application should be limited to the embodying characteristic(s) of the object(s) and/or variations, corresponding thereto and claimed therein.

各出願は、その出願に該当する、およびクレームに含まれる対象物および／または変形例を実施する特徴に限定する。

7.1.5. The split applications shall have the filing date of the original application and the benefit of priority thereof, if applicable.

分割出願は、原出願の出願日、および該当する場合は、原出願の優先権を有するものとする。

7.1.6. The publications referring to the Industrial Designs shall indicate that they refer to a split application. The split application shall be deemed to stand at the same stage of proceedings as the original application, the INPI being in charge of specifying the reference to the documents and petitions that are included with the original application.

意匠に関する刊行物では、分割出願について言及する。分割出願は、手続において原出願と同格とみなし、原出願に添付する書類および申立に関する言及については、INPI が指定する。

Question 4-7 Before the according of the application filing date, is it necessary for the applicant to satisfy the requirements for representation of a design and a design should be found? Or, may the application filing date be accorded without finding a design as long as the formality requirements are satisfied (e.g., the number and size of drawings or photographs)?

Answer Section 4-7

The application filing date may be accorded as long as the formality requirements are satisfied,
形式的な要件が満たされていれば、出願日は認定される。

Question 4-8 In the case specified in Question 4-7, after an applicant makes an amendment in response to an order for amendment that the IP Office issued on the grounds that the requirements for according the application filing date were not satisfied, if said

requirements are satisfied as a result of the amendment, which date does the IP Office accord as the application filing date, either the first application filing date or the date on which the amendment was submitted?

Answer Section 4-8

Amendments are only possible as in Answer Section 4-1

補正は、質問 4-1 で述べた場合にのみ可能である。

Question 4-9 In the case of an IP Office that conducts to find a design as a prerequisite for according the application filing date, please answer this question. In the case of any other IP Office, please skip this question and answer Question 5.

In the case mentioned in Question 4-8, if an amendment submitted to the IP Office changes the gist of the design, how would the amendment be treated? Would it be dismissed? Or, would it be deemed as a new application filed on the date on which the written answer to the order for amendment is submitted? Please explain in detail.

Answer Section 4-9

Question 5 Principle of unity

Question 5- 1 Please tell us the requirements for representations of designs in order for multiple designs to be regarded as a single design.

Please give us a detailed answer. For example, is it the case that the designs of articles that are used in a physically separated manner may be regarded as a single design as long as those designs are regarded as a set in terms of design (e.g., a set of stackable pans), that a set of similar designs may be regarded as a single design as long as those designs are similar to each other in terms of configuration¹, that the designs represented in a drawing in a physically separated manner may be regarded as a single design as long as those articles are used simultaneously (e.g., a pen and its cap), or that the designs of different articles may be regarded as a single design as long as they are used simultaneously (e.g., a stationary article and its base)? Which requirements, either formality requirements (formality examination) or substantive

¹ “Configuration” means here that the shape, patterns or colors, or any combination thereof, of an article. The same shall apply hereinafter.

requirements (substantive examination), must be met in order to recognize multiple designs as a single design? If multiple designs are not regarded as a single design, how would the IP Office treat them?

(Example) In Japan, a design application would be dismissed (i) if the applicant states two or more classifications of articles in the section entitled "Article which constitutes the design" of an application, (ii) if the applicant presents drawings of two or more articles, or (3) in the case of an application for the design of a part of an article, if the application covers two or more physically separated parts. If an application is dismissed for any of the aforementioned reasons, the applicant may file a divisional application (substantive requirements).

Answer Section 5-1

An application for an industrial design registration must refer to a single object, a plurality of variations being permitted, provided that they are destined for the same purpose and maintain between them the same preponderant distinctive characteristic, each application being limited to a maximum of 20 (twenty) variations.

意匠登録の出願は、単一の対象物に関するものでなければならないが、用途が同一であり、主要な識別性の特徴が同一であり、数が 20 以内であることを条件として、複数の変形例が認められる。

Question 5-2 This is a question to the IP Office of any country that protects images. If your country does not protect images, please skip this question and answer Question 6.

Please tell us the provisions concerning representations of drawings that are required to be made in order to have multiple images regarded as a single design. Which requirements, either formality requirements (formality examination) or substantive requirements (substantive examination), must be met in order to have multiple images regarded as a single design? If multiple images are not regarded as a single design, how would the IP Office treat them?

(Example) In Japan, multiple images may be regarded as a single design covering multiple images in the case where the image before a change and the image after the change are used in relation to the same function of an article as long as those two images are considered to be related to each other in terms of configuration. If multiple images are not regarded as a single design, the application would be dismissed on the grounds that multiple images should be regarded as multiple designs (substantive requirements).

Answer Section 5-2

Question 6 Scope of design protection

Question 6-1 Based on what definitions or ideas concerning the similarity of the configurations of designs do you determine the scope of design protection? Please give us any judicial precedent where the court presented its interpretation about how to interpret the scope of design protection from the perspective of configuration similarity, for example, whether the scope of design protection only covers almost identical designs or covers designs of different degrees of similarity (variations).

Answer Section 6-1

Industrial design registrations are protected from non-authorized reproduction and imitation likely to cause confusion among the consumers, as per Section 187, of Brazilian Industrial Property Act. In this sense, the Court of Appeals of State of Rio Grande do Sul (appeal no. 70031286610) has forbidden the production and trade of a package of a floor wax protected by an industrial design registration, because it was confusingly similar to the Plaintiff's one and, therefore, was likely to mislead the consumers.

意匠登録は、ブラジル産業財産法第 187 条に基づいて、無許可の複製や、消費者を混同させるような模造から保護される。この関連で、リオグランデ・ド・スル州控訴裁判所が、被告の床用ワックスのパッケージが、意匠登録で保護されている原告のものと混同するほど類似しており、消費者を誤認させる恐れがあるとして、製造および販売を禁じたという判決がある (No.70031286610)。

Question 6-2 Please explain in detail how the scope of design protection is affected by the identity or similarity of articles or by the identity or similarity of the functions and use of articles. Please give us any judicial precedent where the court presented its interpretation as to how the scope of design protection is affected by these factors.

Besides novelty and industrial application, the Brazilian Industrial Property Act requires that the industrial design must comply with originality requirement to be registered. According to Brazilian scholars, the concept of originality² is similar to distinctiveness, which means that the industrial design must be different of other ones already available in the market. Moreover, originality requirement establishes that the industrial design must embody a real contribution to the state of the art. In this sense, the degree of originality varies from one area to another. For instance, there are products that, due to its function, its originality is limited and, thus, a smaller change in the common industrial design would suffice for complying with originality requirement. Additionally, the originality assessment must be performed having in mind the typical consumer of this product. If the consumer at issue is a highly skilled professional, such analysis should be rendered according to the ability of this professional of realizing the differences of this new industrial design from the others already available in the market. In fact, in the annulment lawsuit involving the design registration no. DI5501700-2, the Second Specialized Board of Appeals for the Second Circuit stated this registration must be annulled, since the industrial design at stake “... lacks of the minimum originality necessary to give a new visual conception to the product, in order to the consumers realize it by its own characteristics and not by the generic ones, which were already applied to ordinary configuration”

ブラジル産業財産法では、意匠の登録には、新規性および産業上の利用可能性の他に、独創性の要件を満たす必要がある。ブラジルの学者等によれば、独創性の概念は、意匠は市場に既にあるものと異なるものでなければならないことを意味する「識別性」と類似している。それに加え、独創性の要件では、その意匠によって、技術水準に対する実質的な貢献がなければならないとされている。この意味において、独創性の程度は分野によって異なってくる。例えば、製品によっては、その機能によって独創性が制限され、そのため、一般的な意匠とのわずかな相違でも、独創性の要件を十分に満たす場合もある。また、独創性の評価は、その製品の典型的な消費者を念頭に置いて実施しなければならない。該当する消費者が高度な技能を備えた専門家であれば、既に市場にある意匠と、新たな意匠の差異を認識できる、専門家の能力に基づいて分析を実施すべきである。現に、意匠登録No.DI5501700-2に関する取消訴訟では、第2巡回区の第2専門審判廷が取消の判断を下し、その理由として、当該意匠は「既に通常の形状に適用されている一般的な特徴ではなく、独自の特徴によって消費者に認識されるための、新たな視覚概念を与えるのに最低限必要な独創性を欠いている」と述べた。

² novelty の誤記と思われる。

Question 6-3 Please explain in detail how the scope of design protection is affected by the parts of an article that are not represented in drawings or photographs.

Answer Section 6-3

In our country it is understood that the design protection covers only the portions effectively represented in the figures.

わが国では、図面で有効に表された部分のみが意匠保護の対象になると理解されている。

Question 6-4 In the case of a design right for an article which partially changes to perform its functions, does the scope for design protection cover the configurations observed in the course of change? Or, does the scope of design protection cover only the configuration before a change and the configuration after the change?

The following is a specific example where a part of an article (toy) that has a three-dimensional configuration changes its configuration to perform its functions.

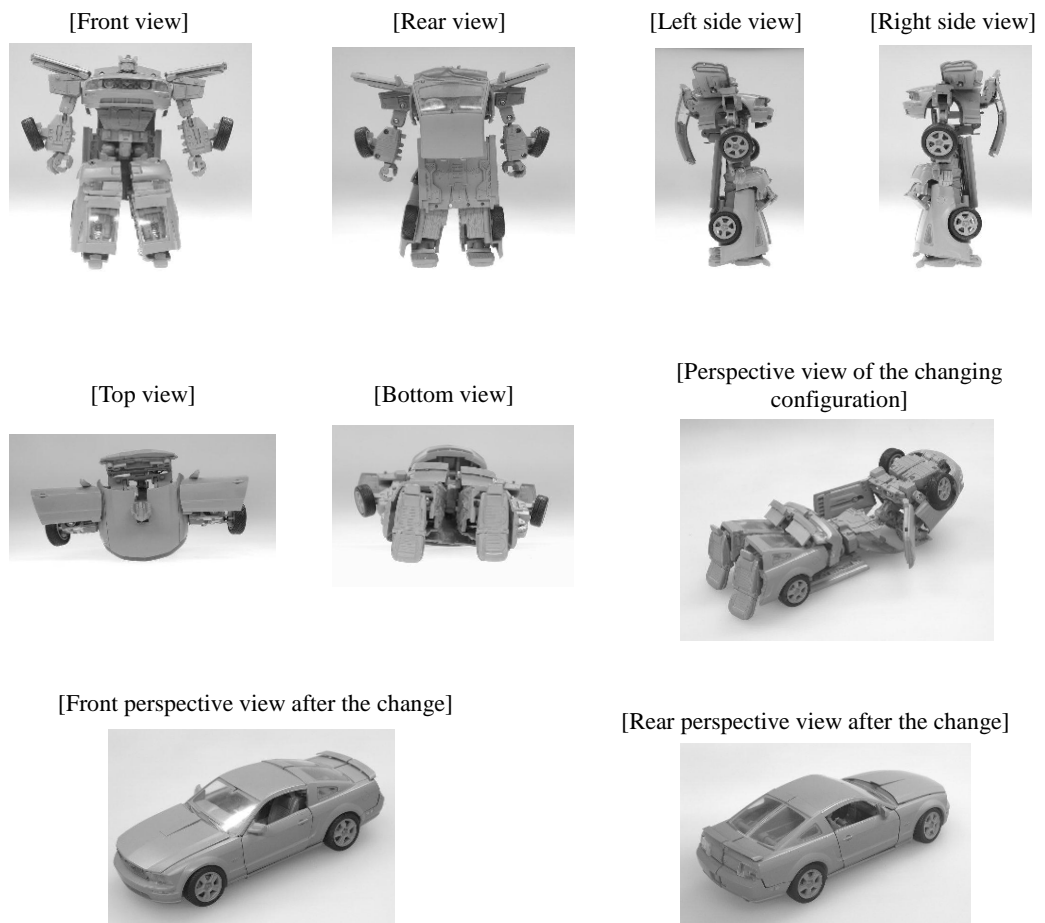

Answer Section 6-4

The Patent Office understands in this case that each form of the article is a single article and a different design should be filed for the distinct forms

特許庁の認識では、このような場合、物品の各形状は単一の物品であり、異なる形状ごとに意匠を出願すべきである。

Question 6-5 This question is about the scope of design protection in the case of a set of articles or a certain set of articles. Does the design protection only cover a set of articles or a certain set articles? Or, does the design protection also cover each article that comprises a set?

If simultaneously used multiple articles are coordinated as a whole, the designs of those articles may be regarded as a single design. Such a design may be regarded as a "design for a set of articles." The term "a design for a certain set of articles" is conceptually the same as "a design for a set of

articles." The term "a design for a certain set of articles" refers to a design used for any of the prescribed types of set.

Answer Section 6-5

In case of a set of elements, the component objects thereof (maximum of 20 objects) should be intended for one single purpose, keeping among each other the same major distinctive characteristics, such as flatware, silverware, glassware set, etc.

組物の場合、構成する対象物（最大 20 まで）は、単一の用途のために作られ、皿類、銀食器、ガラス食器などのように、主要な識別性の特徴も同一でなければならない。

Question 6-6 This is a question about the restrictions on the exercise of design rights that are related to each other in conflict of which both right holders and both filing dates are deferent.

Design rights are considered to be related to each other in conflict in the following three cases:

- (i) a design right to protect the design of a whole article and a design right to protect the design of a component of the article (the component can be regarded as an independent article). Filing date of the design right of a component of the article is earlier than filing date of the design right of a whole article. Both rights are owned by deferent persons;
- (ii) a design right to protect the design of a whole article and a design right to protect the design of a part of the article (a part means a portion of the article and cannot be separated as a component). Filing date of the design right of a part of the article is earlier than filing date of the design right of a whole article. Both rights are owned by deferent persons; and
- (iii) a design right to protect the design of a set of articles or a certain set of articles and a design right to protect the design of any article that comprises a set. Filing date of the design right of any article that comprises a set is earlier than filing date of the design right of a set of articles or a certain set of articles. Both rights are owned by deferent persons.

For example, in Case (i) above, if the holder of a design right to protect the design of a whole article works the design or exercises the design right, is it sometimes necessary for him/her to obtain a license from the holder of a design right to protect the design of a component? How about the situations in Case (ii) and Case (iii) described above in terms of the restrictions on the exercise of design rights?

Answer Section 6-6

In the three cases, it would be necessary, in principle, to request licenses to the right-holders of the senior industrial design registrations. It is important to be noted that the Brazilian Industrial Property Act establishes the possibility of granting compulsory license in similar cases to these ones, but only related to patents (whether invention or utility model patents). However, there is no specific provision for cases of industrial design.

これら 3 つのケースにおいては基本的に、先に登録された意匠権者にライセンスを求める必要がある。ブラジル産業財産法では、これらと類似したケースにおいて、強制実施権を認める可能性が規定されているが、ただし特許（発明特許か実用新案特許を問わない）に関する場合のみである。意匠については、具体的な規定はない。

Question 6-7 This is a question to the IP Office of any country that protects multiple images as a single design.

If your country does not protect multiple images as a single design, please skip this question and answer Question 7.

In the case of two related design rights, i.e., a design right to protect the designs of multiple images and a design right to protect the design of any of those images, are in conflict. Filing date of the design right of any of those images is earlier than filing date of the designs right of multiple images. Both rights are owned by deferent persons. In this case, are any restrictions imposed on the exercise of those design rights?

Answer Section 6-7

Question 6-8 This is a question to the IP Office of any country that protects multiple images as a single design and conducts substantive examination. If your country does not protect multiple images as a single design and does not conducts substantive examination, please skip this question and answer Question 7.

In case of a application seeking for a protection of a design of multiple images When filing date of a application seeking for a protection of design of any those images is earlier than filing date of a application seeking for a protection of a design of multiple images, and both applicants are different, what measures do you take when determining whether such a design has novelty and is not easily creatable by any person skilled in the art?

Answer Section 6-8

Question 7 Disclosure by drawings included in application documents and publication by gazettes

Question 7-1 Are there any cases where a drawing or photograph included in application documents is edited (e.g., altered in size or ratio) when the design is publicized in a design gazette (including an electronic gazette)? If editing is conducted, please tell us the reasons and standards for editing.

Answer Section 7-1

The edition of a design for publication is basically dictated by the dimensions of the page on which the design is to be fitted.

意匠公開の編集は基本的に、掲載するページの寸法に合わせるために要求される。

Question 7-2 If a design application is filed by an electronic medium, do you store printed-out hardcopies of the representations of the design as the original documents in addition to the submitted electronic images of those representations? If yes, why?

Answer Section 7-2

The applications in Brazil are not yet filed electronically.

ブラジルの出願はまだ電子化されていない。

Question 7-3 Does the public have access to the documents (including electronic data) prepared in the course of design prosecution starting from the filing of a design application to the registration of the design? If yes, please tell us the inspection fee and conditions (to what extent is inspection permitted? Are there any documents that are not available for inspection?).

Answer Section 7-3

The public has free access to the documents after the publication either in loco at the Patent Office or even after filing the designs are available only in loco.

公開後の書類は、特許庁において無料で閲覧でき、出願後の意匠も特許庁のみにおいて閲覧できる。

Question 8 Do you receive any opinions from users of the design system such as a request for a revision of the design system in order to change the way of representing a design in a design application under the relevant laws, regulations, and examination guidelines of your country and to remedy the current situation where the way of representing a design differs from one country to another? If yes, please describe those opinions in detail.

Answer Section 8

It is not usual that Applicants in general make suggestions as to prosecution of industrial designs. These questions are more pertinent to IP personal in general and lawyers.

意匠の審査に関して一般の出願人から意見が出されることは通常はない。こうした質問は、知財の専門家や弁護士に関するものである。

Question 9 In recent years, has the number of design applications been on the rise or on the decline? What do you think has caused such increase or decrease?

Answer Section 9

The number of design applications has increased in recent years, possibly by the growth of national economy among other reasons,

近年、意匠出願件数は増加しており、わが国の経済成長やその他の理由があると考えられる。

Question 10 If your country has signed the Hague agreement, please answer this question. Did the number of design applications increase or decrease in your country before and after the signing of the Hague agreement?

Answer Section 10

Brazil has not signed Hague agreement.

ブラジルはヘーグ協定には調印していない。

Question 11 If your country has signed the Hague agreement, please skip this question and answer Question 12.

This is a question to the IP Office of any country that is planning to sign the Hague agreement. What are your purposes for signing the Hague agreement? Please describe your purposes in detail.

Answer Section 11

Question 12 Please answer this question if your country has signed the Hague agreement or is planning to do so. In order to sign the Hague agreement, did you have to make any alterations or adjustments to your country's system? Or, is your country planning to alter or adjust your country's system in the future?

Answer Section 12

[Request for information]

- 13** If your country has adopted a multiple design application system, please send us information on how an application and drawings should be prepared in order to file a multiple design application. We would appreciate if you could send us a sample application and a sample drawing that are available for disclosure (those with all the sections filled in with information as a sample). If such application and drawing are not available for disclosure, please send us a blank application form, etc., if possible.

- 14** Is it possible for you to send us a sample registration certificate? Again, we would appreciate if you could send us such a certificate with all the sections filled in with information as a sample. If such certificate is not available for disclosure, please send us a blank certificate form, if possible.



J.02008



REPÚBLICA FEDERATIVA DO BRASIL
Ministério do Desenvolvimento, Indústria e Comércio Exterior
Instituto Nacional da Propriedade Industrial

CERTIFICADO DE REGISTRO DE DESENHO INDUSTRIAL
Nº DI 6600760-7

O INSTITUTO NACIONAL DA PROPRIEDADE INDUSTRIAL concede, automaticamente, sem exame de mérito, o presente CERTIFICADO DE REGISTRO, que outorga ao seu titular a propriedade do desenho industrial discriminado neste título, em todo o território nacional, garantindo os direitos dele decorrentes, previstos na legislação em vigor.

(21) Número do Depósito : DI6600760-7

(22) Data do Depósito : 08/03/2006

(45) Data da Concessão: 22/08/2006

(52) Classificação Internacional de Desenhos Industriais: 09-01.B 0350,

(30) Prioridade Unionista : 09/09/2005 EM 000398698-0001

(54) Título : CONFIGURAÇÃO APLICADA EM RECIPIENTE TIPO GARRAFÃO OU JARRO DE MATERIAL PLÁSTICO

(73) Titular : Concordia Development S.R.L. Companhia Italiana, Endereço: Via Valvassori Peroni Carlo 55, 20133 Milão, Itália(IT).

(72) Autor: Gianfilippo Pagliacci. Empresário(a), Endereço: Via Cassiodoro, 12, 20145 Milão, Itália. Cidadania : Italiana.

Prazo de Validade : 10(dez) anos contados a partir de 08/03/2006, observadas as condições legais.
Expedida em : 22 de Agosto de 2006.

Breno Bello de Almeida Neves
Diretor de Contratos de Tecnologia e Outros Registros

Frederico Carlos da Cunha
Coordenador de Desenho Industrial e Indicação Geográfica



“CONFIGURAÇÃO APLICADA EM RECIPIENTE TIPO GARRAFÃO OU JARRO DE MATERIAL PLÁSTICO”

O presente desenho industrial de uma configuração aplicada em recipiente tipo garrafão ou jarro de material plástico proporciona um caráter ornamental que é descrito com referência às figuras 1 a 7 anexas que representam diversas vistas da configuração aplicada em recipiente tipo garrafão ou jarro de material plástico que constitui o objeto do presente desenho industrial.

REIVINDICAÇÃO

1. Configuração aplicada em recipiente tipo garrafão ou jarro de material plástico, caracterizada pelo fato de que é como ilustrada nas figuras 1-anexas.

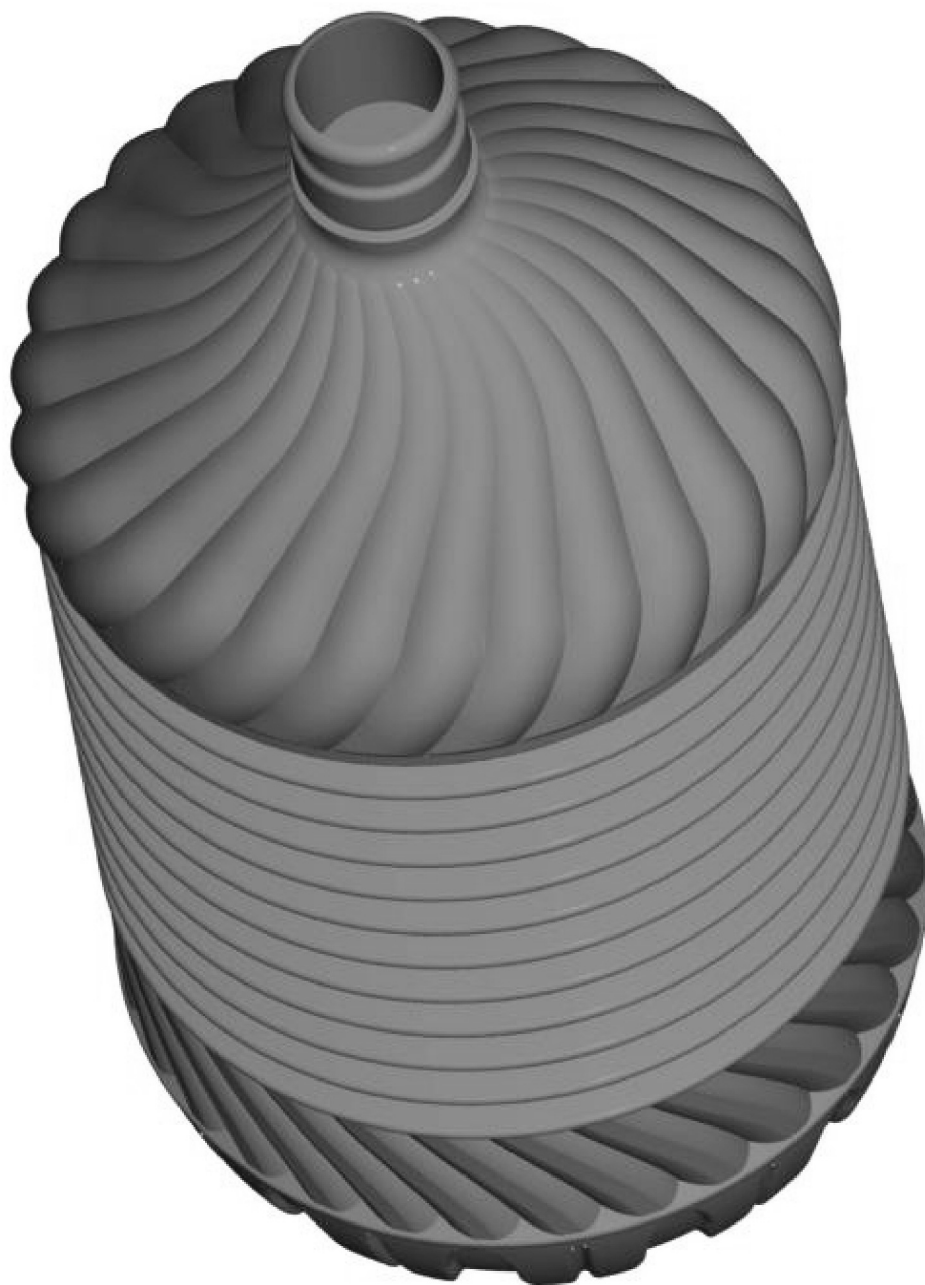

FIG. 1



FIG. 2



FIG. 3



FIG. 4

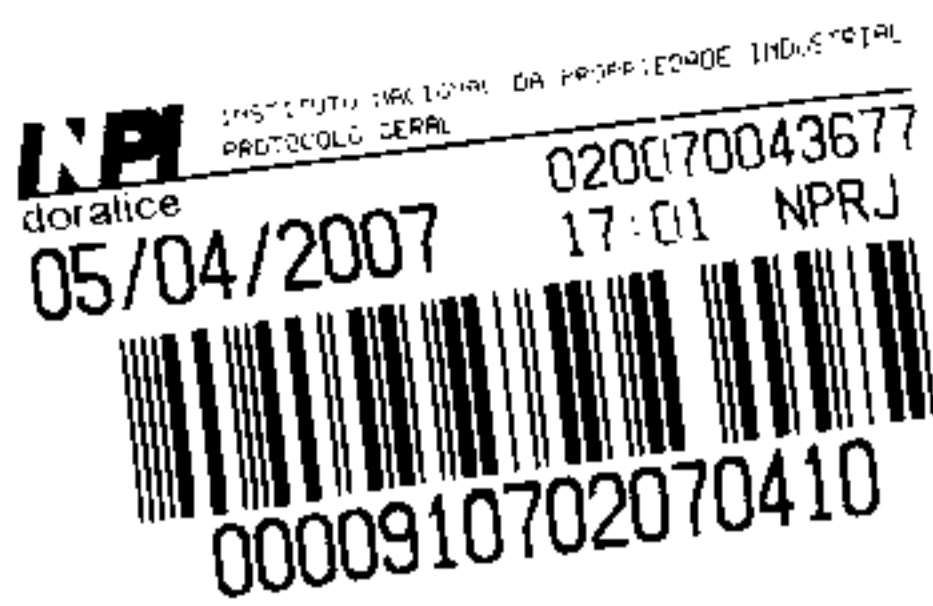

Protocolo

(Uso exclusivo do INPI)

Número(21)

DEPÓSITO Pedido de Registro de Desenho Industrial	depósito / / Espaço reservado para etiqueta (número e data de depósito)
--	--

Ao Instituto Nacional da Propriedade Industrial:

O requerente solicita a concessão de um registro de desenho industrial nas condições abaixo indicadas:

1. Depositante (71):

1.1 Nome: SONY ERICSSON MOBILE COMMUNICATIONS AB

1.2 Qualificação: COMPANHIA SUECA.

1.3 CNPJ/CPF:

1.4 Endereço completo: NYA VATTENTORNET, S-221 88 LUND, SUÉCIA.

1.5 Telefone:

FAX:

() continua em folha anexa

2. Título do Registro de Desenho Industrial:

"CONFIGURAÇÃO APLICADA EM DISPOSITIVO DE COMUNICAÇÃO PORTÁTIL."

() continua em folha anexa

3. Campo de aplicação:

DISPOSITIVOS DE COMUNICAÇÃO.

4. Prioridade

4.1 (X) o depositante reivindica a(s) seguinte(s) prioridade(s):

País ou organização de origem	Número do depósito	Data do depósito
US	29/275228	18/12/2006

() continua em folha anexa

5. Requer sigilo na forma do § 1º do art. 106 da LPI. () sim (X) não

6. Autor:

() Assinale aqui se o(s) mesmo(s) requer(em) a não divulgação de seu(s) nome(s) (art. 6º § 4º da LPI e item 1.1 do Ato Normativo nº 129/27)

6.1 Nome: Sang Beom Kim

6.2 Qualificação: engenheiro, coreano.

6.3 CPF(se houver):

6.4 Endereço completo: 101 Crimmons Circle, Cary, Carolina do Norte 27511, Estados Unidos da América.

6.5 Telefone:

Fax:

() continua em folha anexa

7. Declaração da forma do item 3.2 do Ato Normativo nº 129/97:

() em anexo

8. Declaração de divulgação anterior não prejudicial (art. 96 § 3º da LPI - Período de graça):

() em anexo

9. Procurador (74):

9.1 Nome: MOMSEN, LEONARDOS & CIA.

CNPJ. 33.146.895/0001-26

9.2 Endereço completo: Rua Teófilo Otoni, 63 - 10º andar, Rio de Janeiro - RJ.

9.3 Telefone: (021) 2518-2264

FAX: (021) 2518-3152

10. Documentos anexados: (assinale e indique também o número de folhas):
(Deverá ser indicado o nº total de somente uma das vias de cada documento)

Apresenta	Folhas
<input checked="" type="checkbox"/> 10.1 Guia de recolhimento	1
<input checked="" type="checkbox"/> 10.2 Procuração	2
<input type="checkbox"/> 10.3 Documentos de prioridade	
<input type="checkbox"/> 10.4 Documento de contrato de trabalho	
<input checked="" type="checkbox"/> 10.5 Relatório descritivo	3
<input checked="" type="checkbox"/> 10.6 Reivindicações	1
<input checked="" type="checkbox"/> 10.7 Desenhos ou fotografias (X) preto e branco	13
<input type="checkbox"/> 10.8 Desenhos ou fotografias () em cores	
<input type="checkbox"/> 10.9 Campo de Aplicação	
<input type="checkbox"/> 10.10 Outros (especificar):	
10.11 Total de folhas anexadas	20

11. Declaro, sob penas da Lei, que todas as informações acima prestadas são completas e verdadeiras:

Rio de Janeiro, RJ. 5 de Abril de 2007

MOMSEN, LEONARDOS & CIA. - Matrícula Nº 353

GUSTAVO JOSÉ F. BARBOSA
Agente da Propriedade Industrial
Matrícula n.º 253

Formulário I.06- Depósito de Pedido de Registro de Desenho Industrial (fl. 2/2)

D02299/AG08780/RQ20360/07285014/CO10647935/DDale/RCVPereira

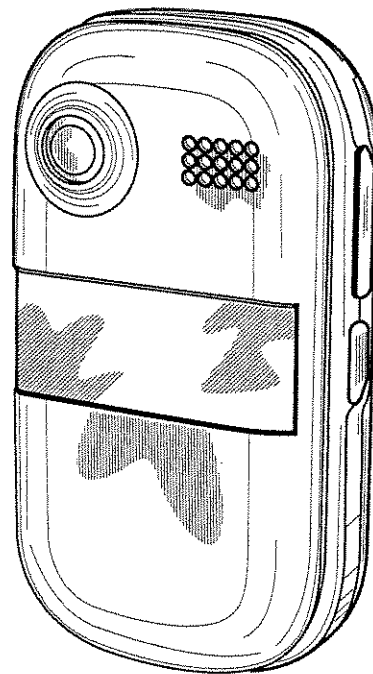

FIG. 1.1

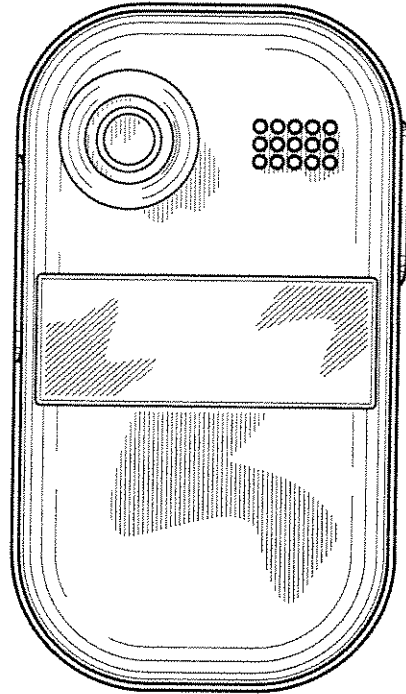

FIG. 1.2

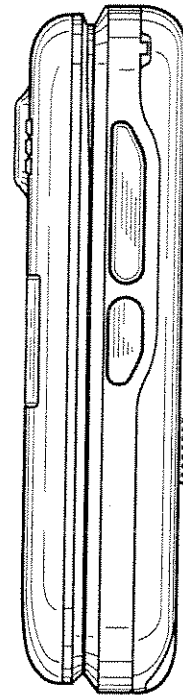

FIG. 1.3

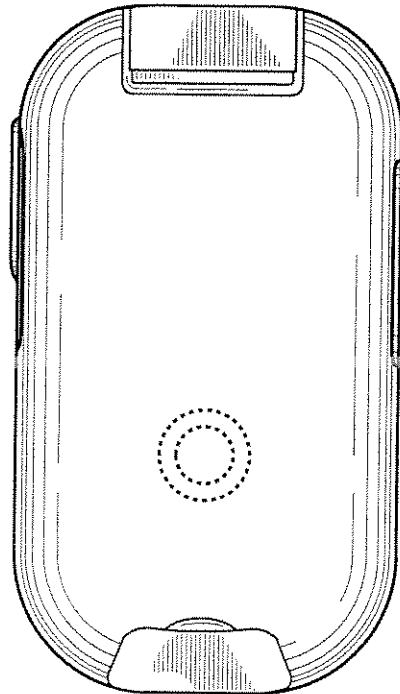

FIG. 1.4

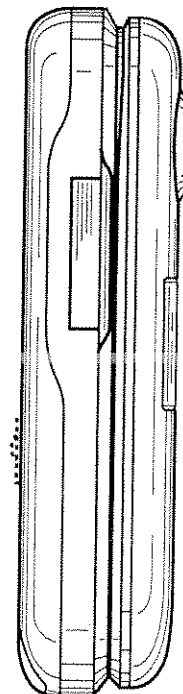

FIG. 1.5

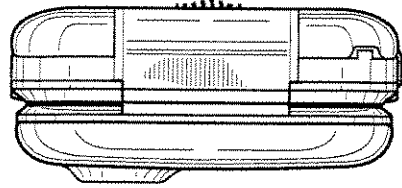

FIG. 1.6

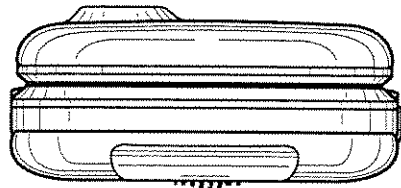

FIG. 1.7

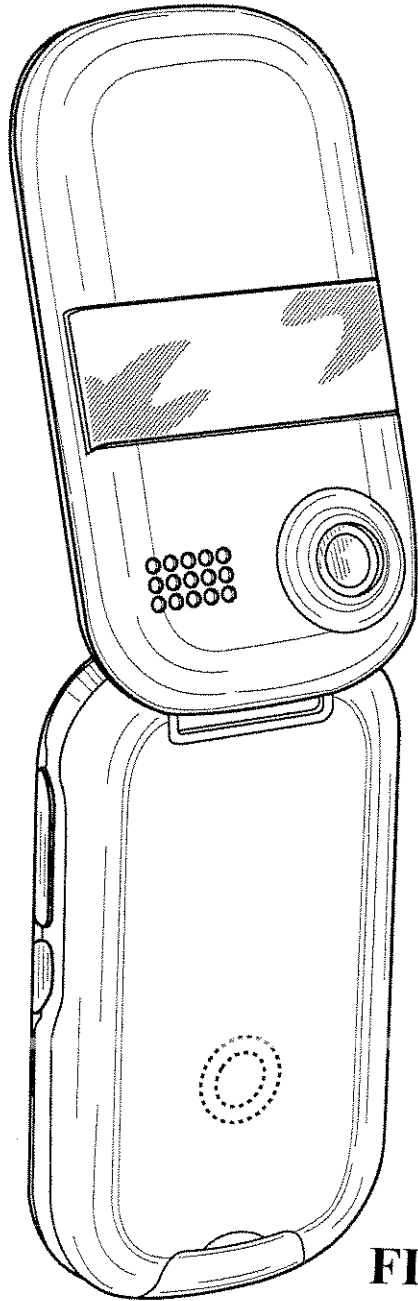

FIG. 1.8

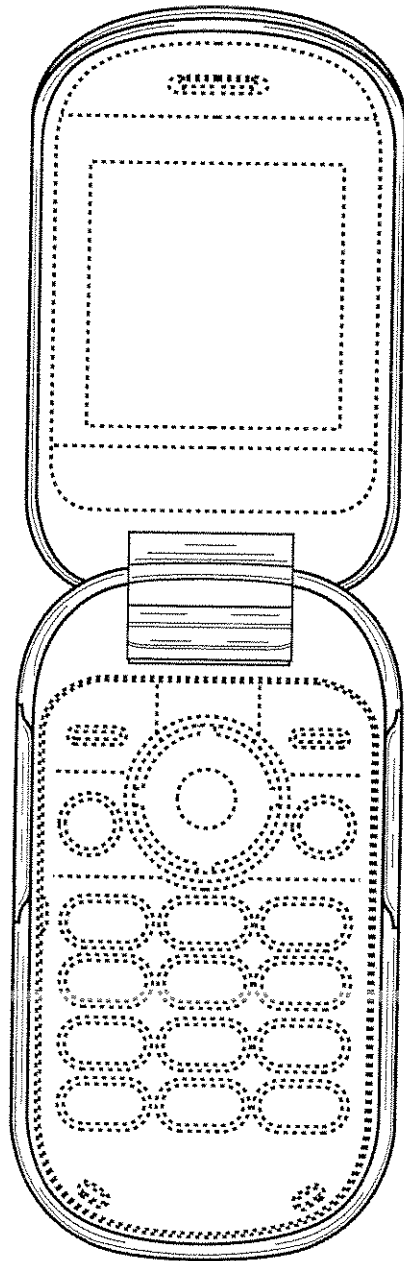

FIG. 1.9

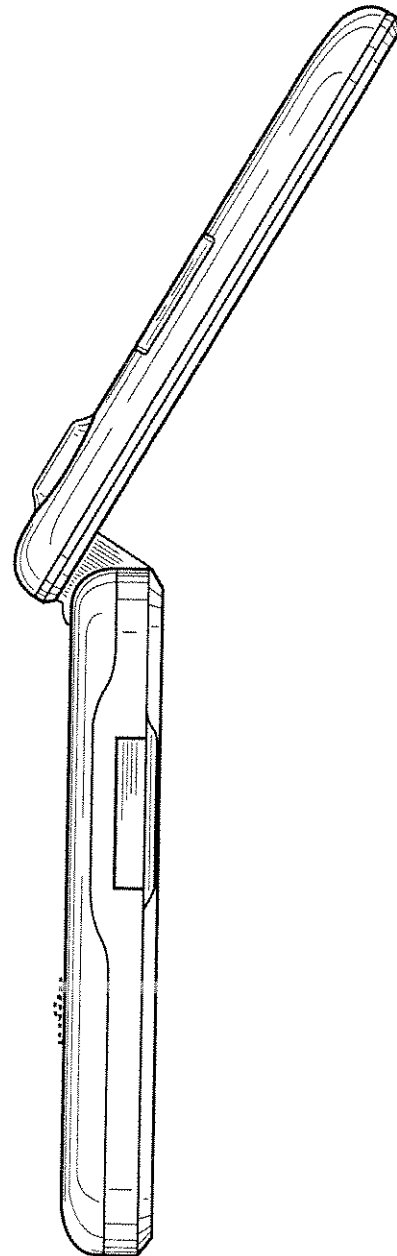

FIG. 1.10

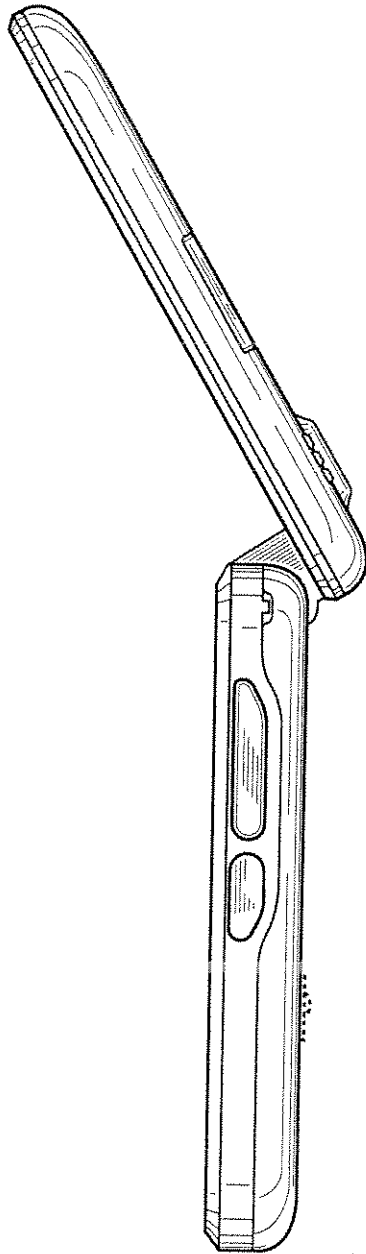

FIG. 1.11

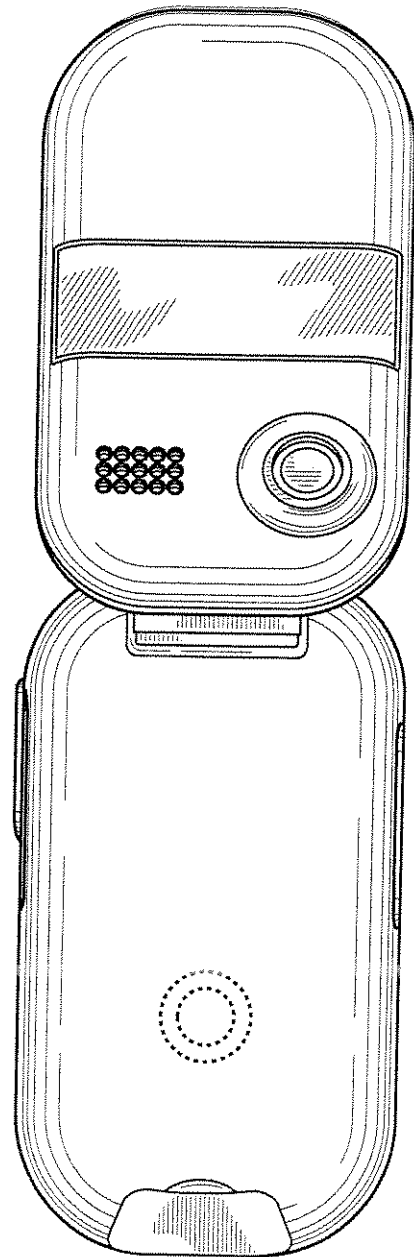

FIG. 1.12

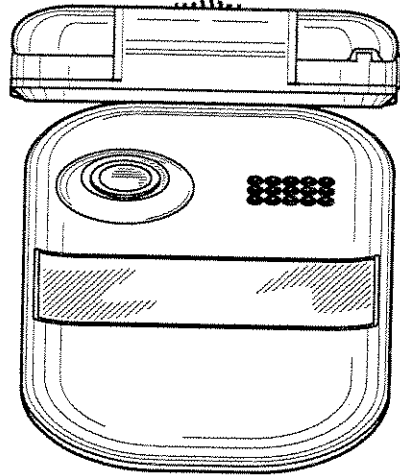

FIG. 1.13

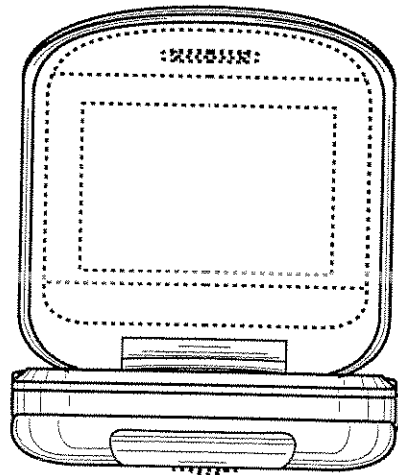

FIG. 1.14

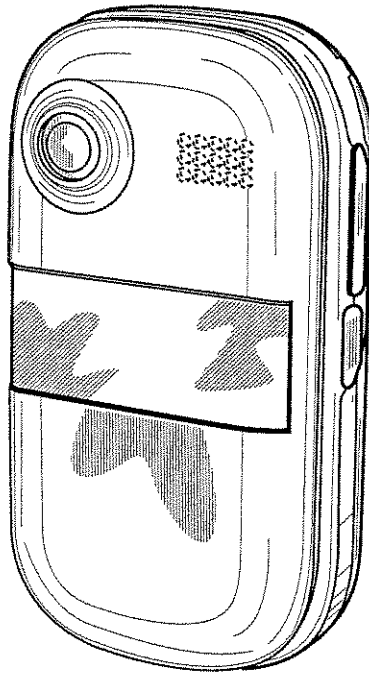

FIG. 2.1

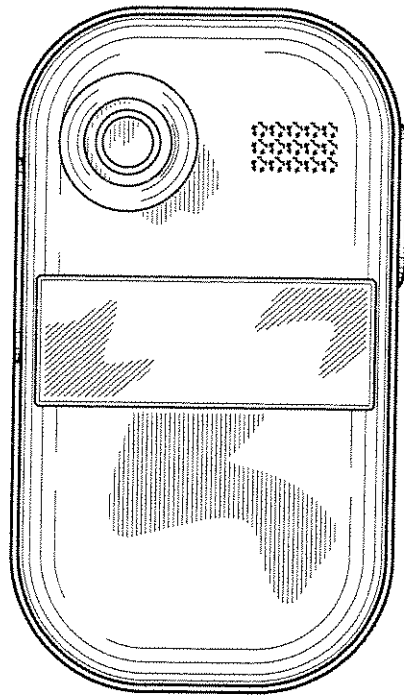

FIG. 2.2

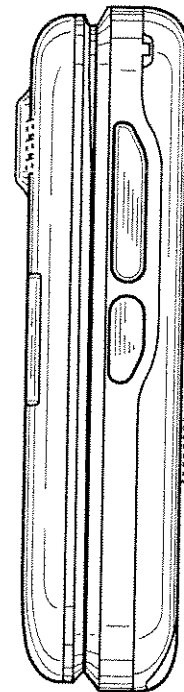

FIG. 2.3

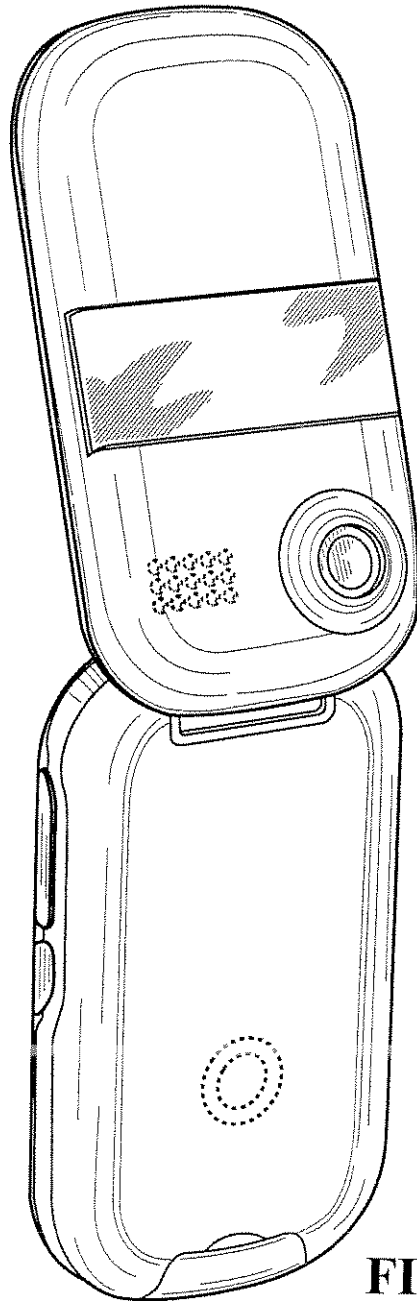

FIG. 2.4

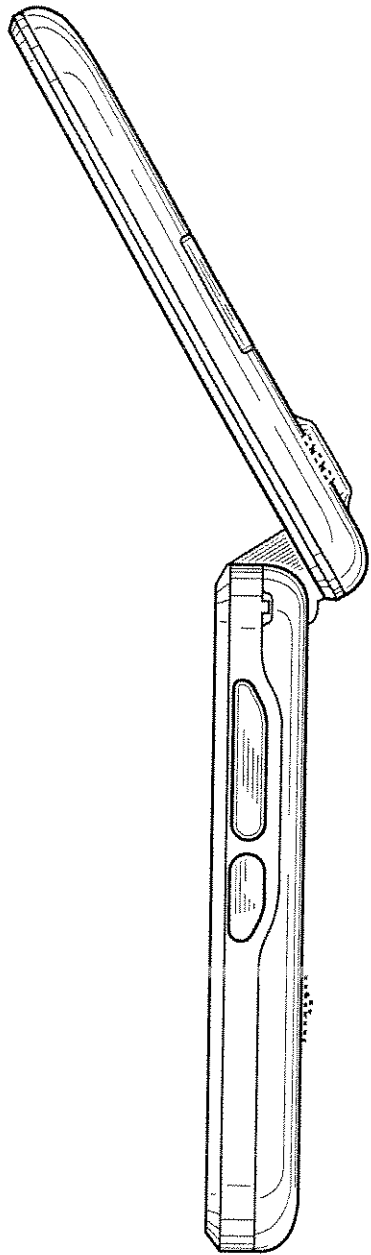

FIG. 2.5

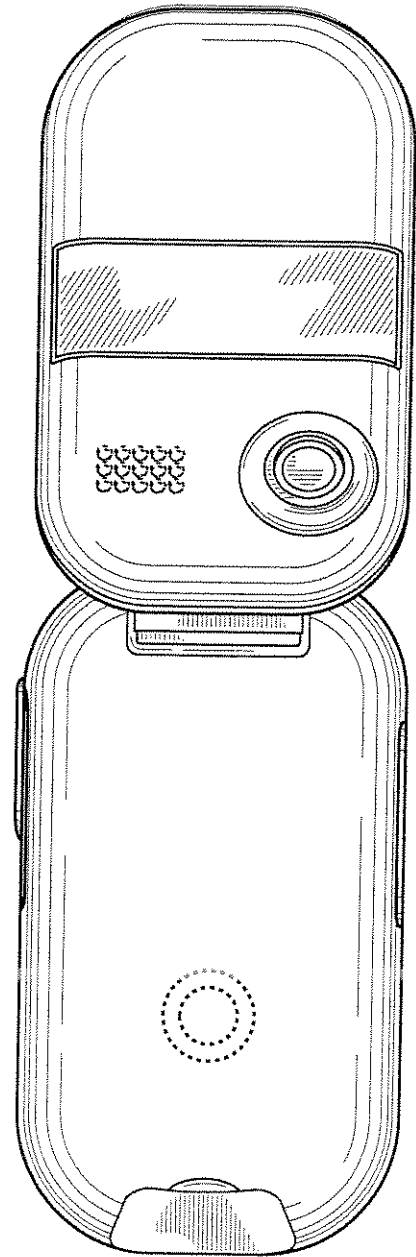

FIG. 2.6

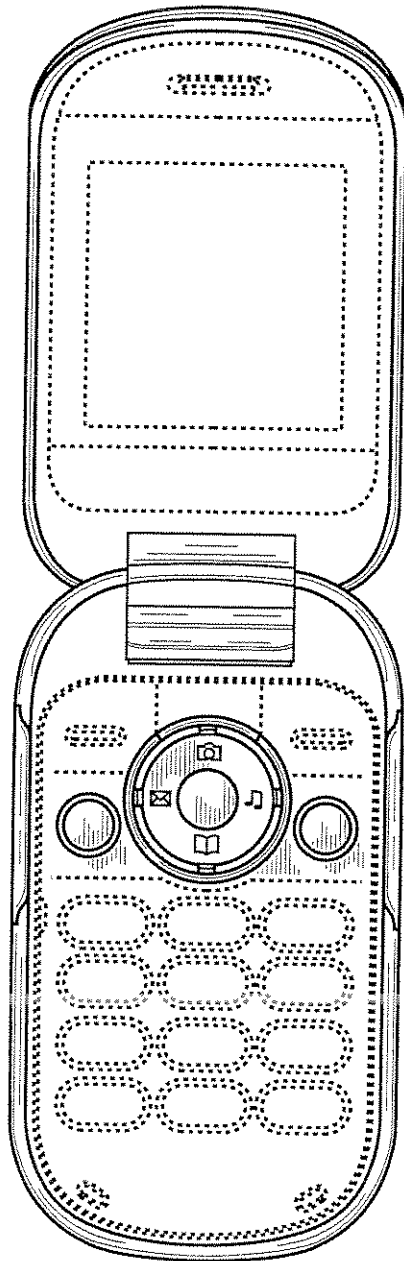

FIG. 3.1

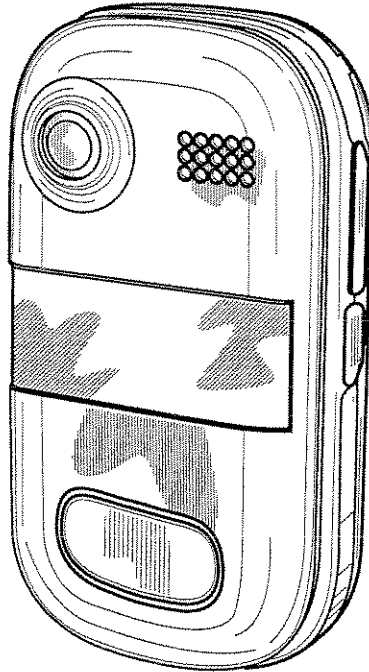

FIG. 3.2

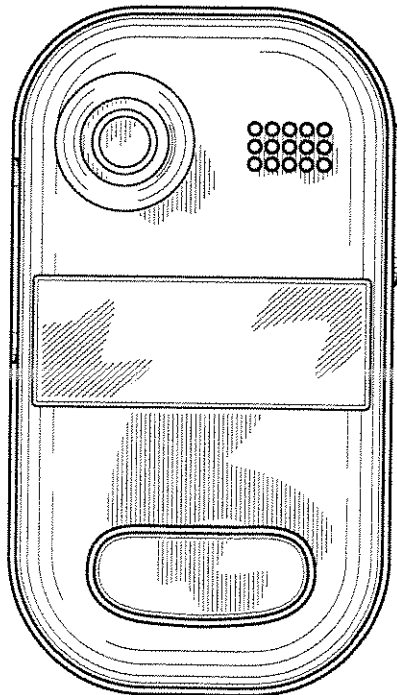

FIG. 3.3

“CONFIGURAÇÃO APLICADA EM DISPOSITIVO DE COMUNICAÇÃO PORTÁTIL”

O presente desenho de uma configuração aplicada em dispositivo de comunicação portátil promove um caráter ornamental descrito com referência às figuras anexas nas quais:

A figura 1.1 representa uma vista em perspectiva frontal de uma primeira versão da configuração aplicada em dispositivo de comunicação portátil que constitui o objeto do presente desenho industrial, em uma configuração fechada.

A figura 1.2 representa uma vista frontal da configuração aplicada em dispositivo de comunicação portátil da figura 1.1.

A figura 1.3 representa uma vista de um lado da configuração aplicada em dispositivo de comunicação portátil da figura 1.1.

A figura 1.4 representa uma vista de trás da configuração aplicada em dispositivo de comunicação portátil da figura 1.1.

A figura 1.5 representa uma vista do lado oposto da configuração aplicada em dispositivo de comunicação portátil da figura 1.3.

A figura 1.6 representa uma vista de uma extremidade de topo a configuração aplicada em dispositivo de comunicação portátil da figura 1.1.

A figura 1.7 representa uma vista da extremidade de baixo da configuração aplicada em dispositivo de comunicação portátil da figura 1.1.

A figura 1.8 representa uma vista em perspectiva lateral da configuração aplicada em dispositivo de comunicação portátil da figura 1.1, em uma configuração fechada.

A figura 1.9 representa uma vista frontal da configuração aplicada em dispositivo de comunicação portátil da figura 1.8.

A figura 1.10 representa uma vista de um lado da configuração aplicada em dispositivo de comunicação portátil da figura 1.8.

A figura 1.11 representa uma vista do lado oposto da

configuração aplicada em dispositivo de comunicação portátil da figura 1.8.

A figura 1.12 representa uma vista de trás da configuração aplicada em dispositivo de comunicação portátil da figura 1.8.

5 A figura 1.13 representa uma vista de uma extremidade da configuração aplicada em dispositivo de comunicação portátil da figura 1.8.

A figura 1.14 representa uma vista da extremidade oposta da configuração aplicada em dispositivo de comunicação portátil da figura 1.8.

10 A figura 2.1 representa uma vista em perspectiva frontal de uma segunda versão da configuração aplicada em dispositivo de comunicação portátil que constitui o objeto do presente desenho industrial, em uma configuração fechada, com a série de círculos no topo excluída, e as superfícies internas (visíveis quando o dispositivo está aberto) e características associadas estão excluídas nesta versão.

15 A figura 2.2 representa uma vista frontal da configuração aplicada em dispositivo de comunicação portátil da figura 2.1.

A figura 2.3 representa uma vista de um lado da configuração aplicada em dispositivo de comunicação portátil da figura 2.1.

20 A figura 2.4 representa uma vista em perspectiva lateral da configuração aplicada em dispositivo de comunicação portátil da figura 1.1, em uma configuração aberta.

A figura 2.5 representa uma vista de um lado da configuração aplicada em dispositivo de comunicação portátil da figura 2.4.

25 A figura 2.6 representa uma vista de trás da configuração aplicada em dispositivo de comunicação portátil da figura 2.4, (as vistas de extremidade e a outra vista lateral são ilustradas nas figuras 1.5-1.7, 1.10, 1.13 e 1.14 acima).

A figura 3.1 representa uma vista frontal de uma terceira versão da configuração aplicada em dispositivo de comunicação portátil que constitui o objeto do presente desenho industrial, em uma configuração

aberta. Esta vista substitui aquela mostrada na figura 1.9 na versão mostrada com respeito às figuras 1.1-1.8 e 1.10-1.14 acima, as vistas restantes para esta versão correspondendo às vistas mostradas com respeito à primeira versão figuras 1.1-1.8 e 1.10-1.14.

5 A figura 4.1 representa uma vista em perspectiva frontal de uma quarta versão da configuração aplicada em dispositivo de comunicação portátil que constitui o objeto do presente desenho industrial, em uma configuração fechada.

10 A figura 4.2 representa uma vista frontal da configuração aplicada em dispositivo de comunicação portátil da figura 4.1. As vistas de trás, de lado e de extremidade correspondem às figuras 1.3-1.7. As vistas da configuração abertas são excluídas nesta versão.

REIVINDICAÇÃO

1. Configuração aplicada em dispositivo de comunicação portátil, caracterizada por ser substancialmente conforme figuras anexas e todas suas variantes.

1 / 1

Campo de Aplicação

Dispositivos de comunicação

Interview Survey on IP Offices Concerning Representations of Designs

Name of the Country: **Turkey**

Time and Date of Visit (or Telephone conference): **07.11.2012**

Visited IP Office: **The Turkish Patent Institute**

Name of the Person Representing the IP Office (Please write if possible): ---

Names of the Visitor and the Firm: **İbrahim İskender at Destek Patent Inc.**

Question 1 Basic principle concerning representations of designs

Question 1-1 In the laws, regulations, examination guidelines, etc., of your country, there are provisions concerning the disclosure of designs. What is the underlying principle behind those provisions that determines the extent of disclosure of designs? In other words, when determining the extent of disclosure of designs, what are the primary goals of your country?

Example answers are listed below. Please give us a detailed answer.

- To facilitate formality examination or substantive examination.
- To facilitate storage of the submitted representations (drawings, photographs, specimens, etc.).
- To reduce the burdens on the users of the design system.
- To facilitate understanding of third parties (those other than design applicants and design holders)
- To facilitate the enforcement of rights.
- To ask for self-responsibility of the applicant who discloses his/her design.

Answer Section 1-1

In the Decree-Law No 554 Pertaining to the Protection of Industrial Designs (*The Decree-Law hereinafter*), the aims are to protect the designs conforming to the provisions of this Decree-Law, and to facilitate the formation and development of the industry and of the competitive environment. The Decree-Law encompasses the principles, the rules and conditions for the protection of registered designs. For non-registered designs the general provisions shall prevail. Also the rights conferred by this Decree-Law do not in any way invalidate the protection conferred by the Literary and Artistic Works Law.

意匠の保護に関する法律第 554 号（意匠法）の目的は、本法の規定に則る意匠を保護し、産業および競争環境の形成および発展を促すことである。意匠法には、登録意匠保護に関する原則、規則および条件が含まれる。未登録意匠には一般的法規が適用される。また、意匠法により付与される権利が、文学的および美術著作物に関する法律により付与される保護を失効させることは一切ない。

In the Implementing Regulations, the object of the Regulation is to specify the procedures and

the rules to be followed concerning the time and place of filing and the preparation of the application documents for registering an industrial design, and other matters related with designs as provisioned in The Design Decree-Law. This Regulation encompasses the principles, the rules and the conditions for the protection of designs by granting certificates to those designs conforming to the design registration provisions.

意匠規則の目的は、工業意匠の登録に係る出願書類の提出および作成の時および場所に関して遵守すべき手続および規則、ならびに意匠法に規定の意匠に係るその他の事項を規定することである。意匠規則は、意匠登録規定に従う意匠に対する証明書の付与による意匠の保護に係る原則、規則および条件を範囲とする。

The underlying principle behind those provisions and regulations that determines the extent of disclosure of designs is to facilitate the enforcement of rights, to facilitate formality examination, and to ask for self-responsibility of the applicant who discloses his/her design.

意匠の開示の程度を決める規定や規則の根底にある考え方は、権利行使をしやすくする、方式審査を容易にする、および意匠を開示する出願人の自己責任に委ねることである。

Question 1-2 In many cases, designers design industrial products by using 3D CAD and CG software. Does your country allow design applicants to use the 3D CG images created in the stage of product design such as those shown below as design representations to be included in design application documents?

[Article which constitutes the Design] Attachable wash-basin

[International Design Classification] 23-02

[Description of the Article which constitutes the Design] This design will be used mostly by medical staff to wash their hands in medical facilities, etc.

[Description of the Design] Each drawing was created using computer graphics software. The shading applied to the entire surface of the 3D configuration presented in each drawing shows the shape of the curved surface.

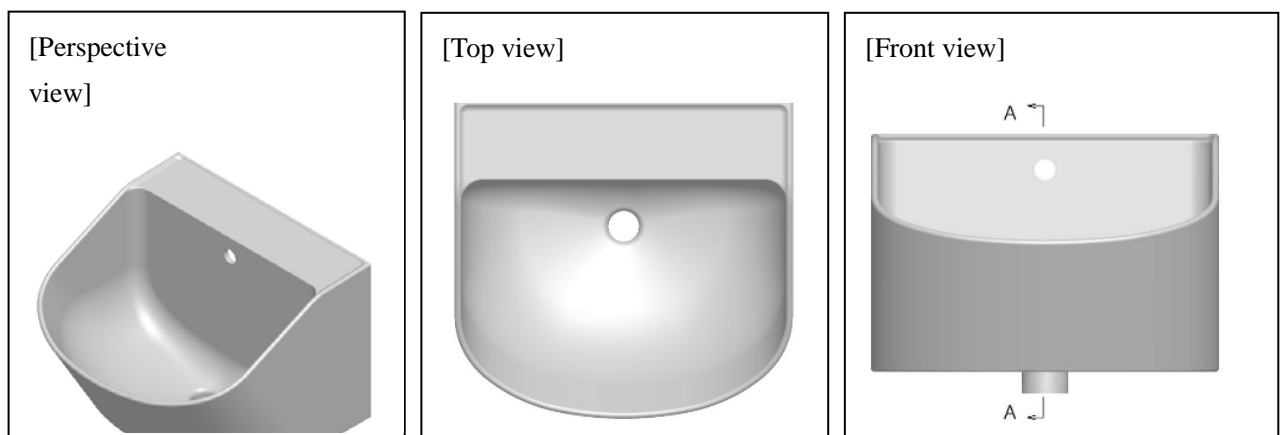

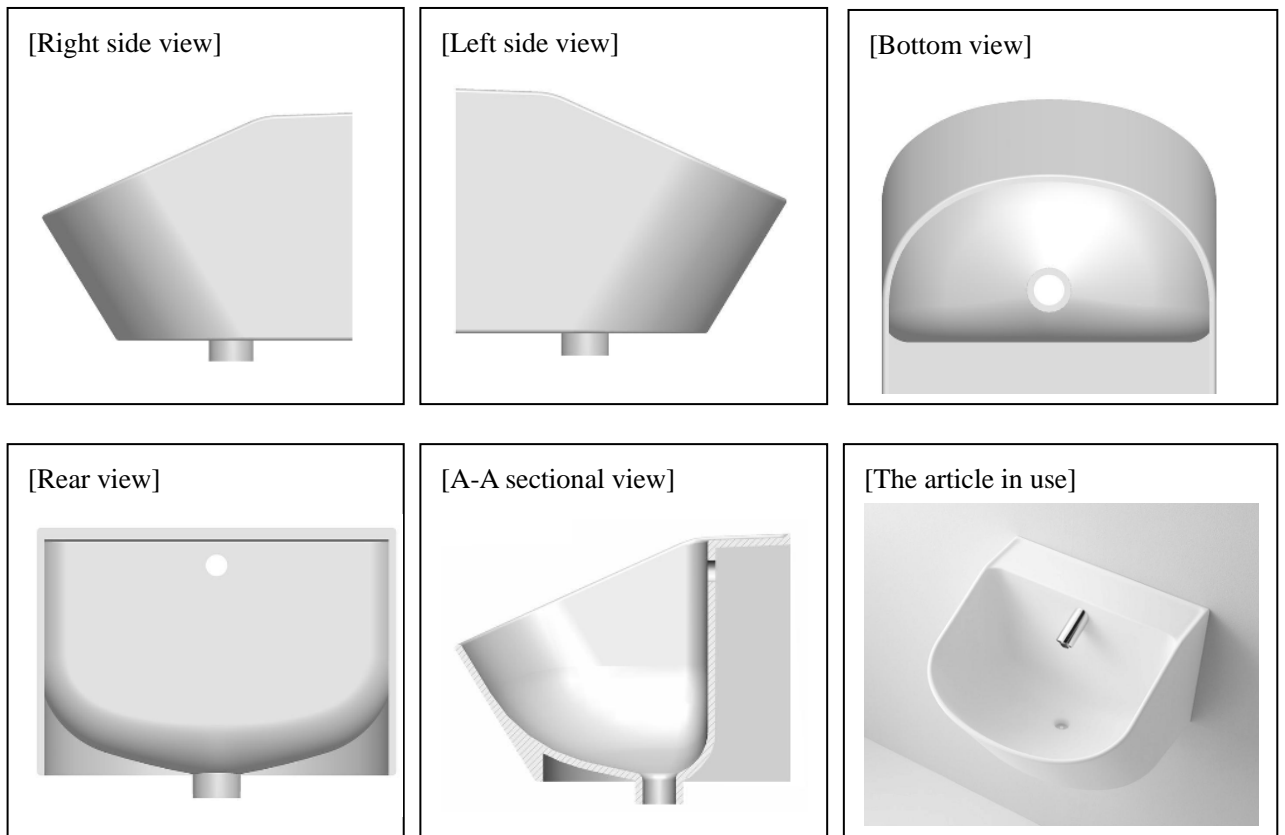

Japan Design Registration No. 1442550

Answer Section 1-2

Turkey allows design applicants to use the 3D CG images created in the stage of product design (Please also see enclosure 1). In general, sectional views as in the example above are not acceptable in Turkey according to the Article 9/a-7 of the Implementation Regulation; However, there are some contradictory examples in which TPI accepts the sectional views after the applicant's objection.

トルコでは、製品の設計段階で作成した 3D CG画像を、意匠出願に用いることができる (Enclosure 1 を参照)。一般には、上記の例のような断面図は、意匠規則第 9/a-7 条に基づき、トルコでは認められない。しかし、出願人が異議を申し立てた後、トルコ特許庁が断面図を受理したという矛盾する例もいくつかある。

Question 2 Representations of designs under the system to protect the design of a part of an article (partial design system)

Question 2-1 This is a question to the IP Office of any country that has either a partial design system or a system to protect the design of a part of an article. If you are representing the IP Office of any country that has neither of these systems, please skip this question and answer Question 2-2.

Two specific examples of representations of partial designs are given below. In the case of Example 1, an applicant seeking protection for a partial design used a different color to distinguish the partial design from the rest of the article. In the case of Example 2, an applicant seeking protection for a partial design used a different line (broken line) to distinguish the partial design from the rest of the article. Does your country allow such representations of partial designs? Please tell us whether and why each of the following two methods shown in the following examples is permitted or not?

(Example 1) A case where an applicant seeking protection for a partial design used a different color to distinguish the partial design from the rest of the article

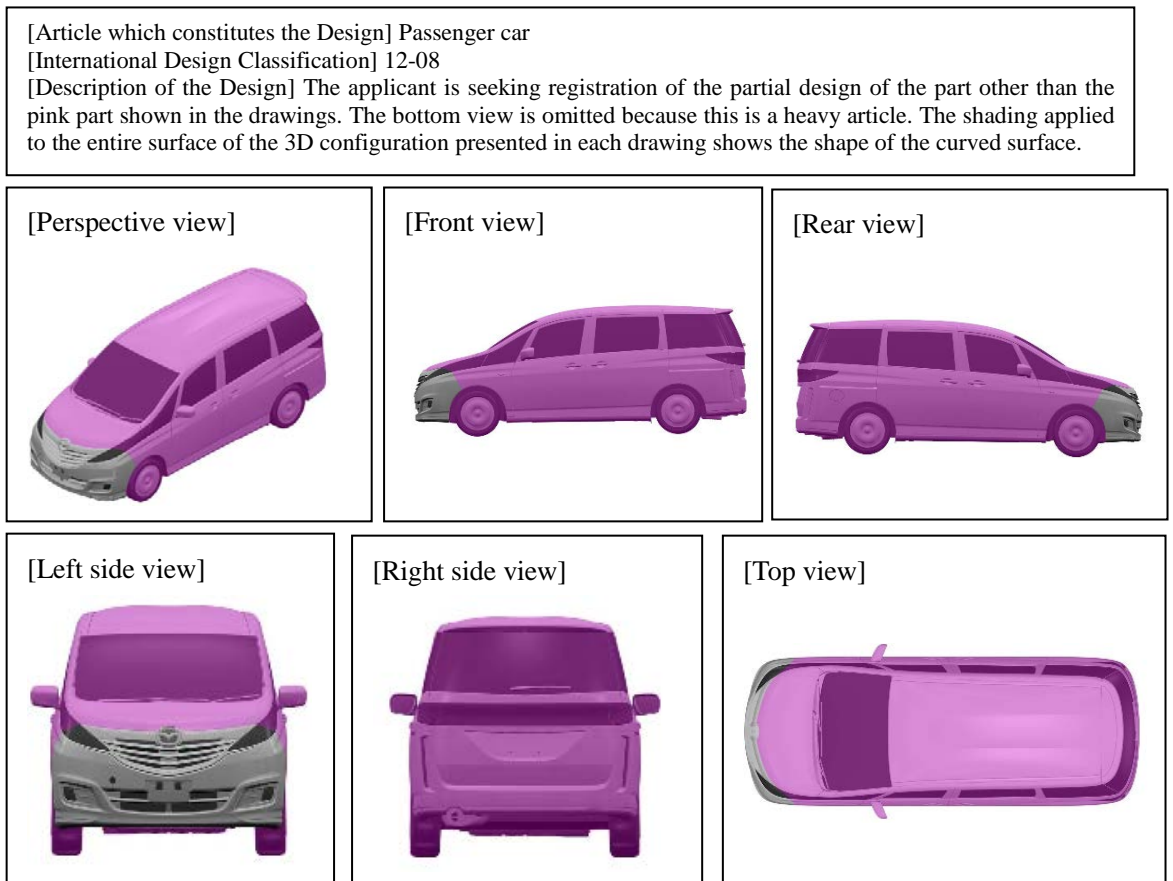

Japan Design Registration No. 1444223

(Example 2) A case where an applicant seeking protection for a partial design used a different line to distinguish the partial design from the rest of the article

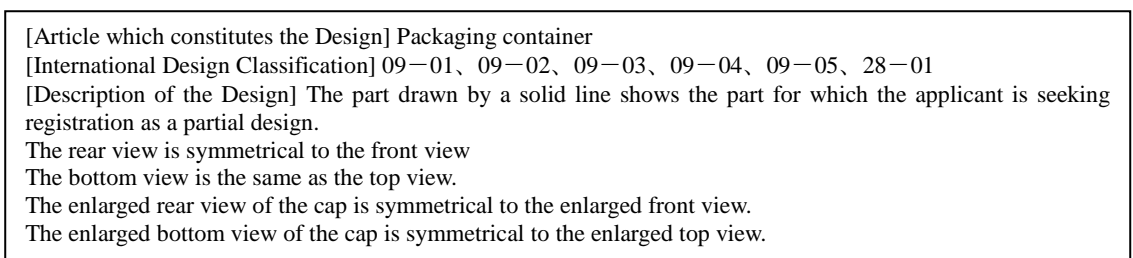

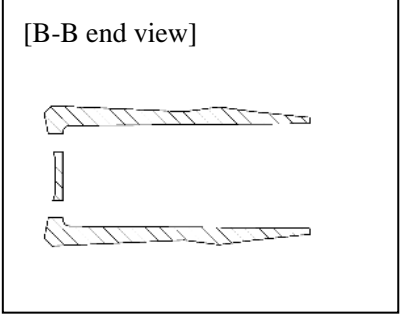
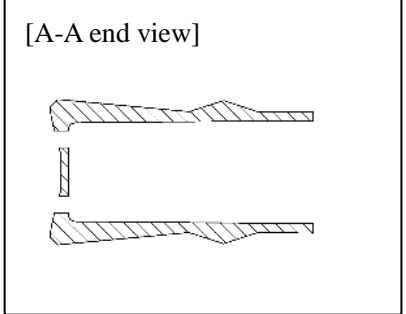
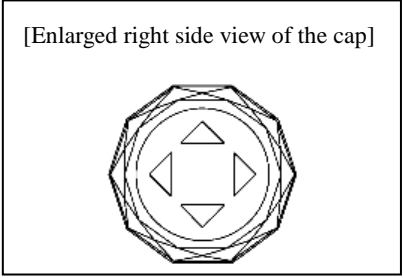
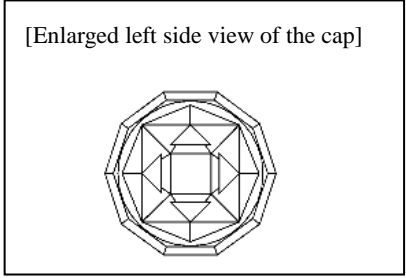
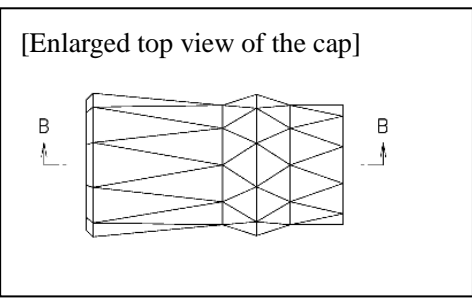
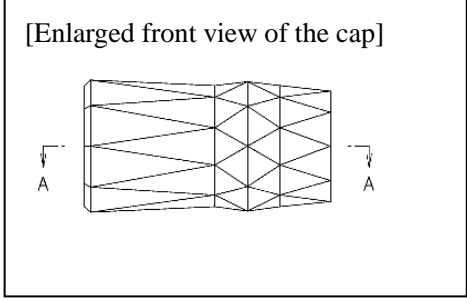
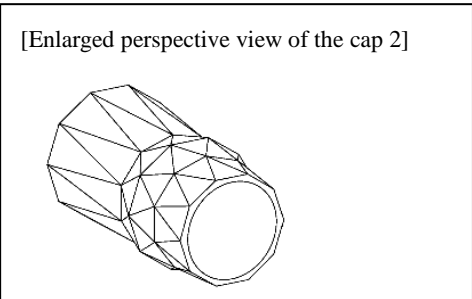
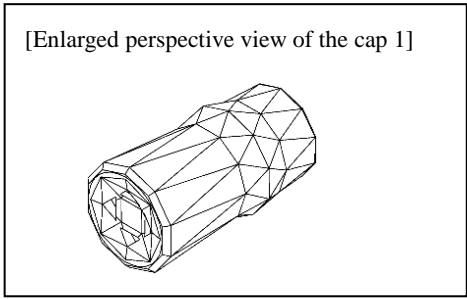
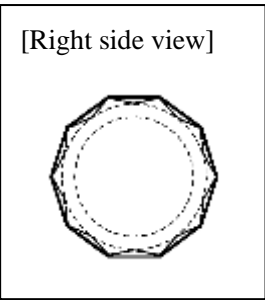
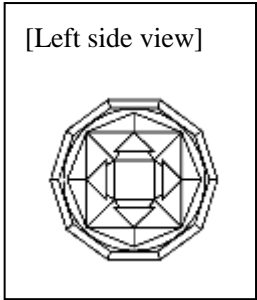
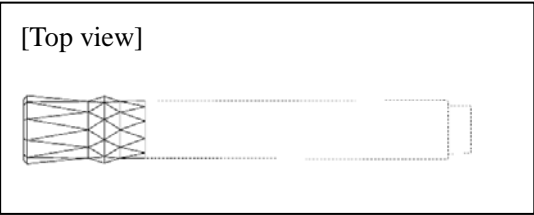
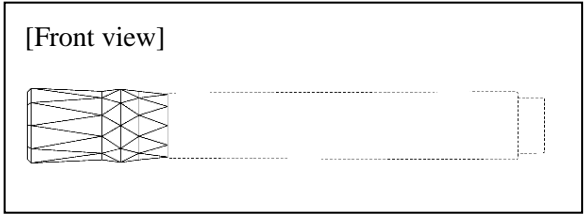

Answer Section 2-1

Turkey allows such representations of partial designs as in Example 2 due to the Article 9/5 of the Industrial Design Implementation Regulation; “if a portion of the design is claimed to be protecting, then the drawing parts, which are outside the protection claim, are presented as dotted or dashed lines. If the visual element is a photo, then the drawing sections, which are in the scope of the protection claim, must be clearly marked.”

例 2 のような部分意匠の表現は、意匠規則第 9/5 条よって認められる：「意匠の一部の保護を主張する場合、保護主張に含まれない図面の部分は、点線または破線で示す。視覚要素が写真の場合、保護主張の範囲に含まれる図面の部分は、明瞭に示さなければならない。

However using a different color to distinguish the partial design from the rest of the article is not permitted in Turkey. As color pictures can be filed as visuals in Turkey, using a different color to distinguish the partial design from the rest of the article may cause

- **misunderstanding of scope of protection, and**
- **misunderstanding the color of the article itself i.e. it cannot be identified well.**

しかし、部分意匠を、その他の部分と違う色を使って区別することは、トルコでは認められていない。カラーの画像を図面として提出することは認められているため、異なる色を使って、部分意匠をその他の部分と区別すると、次のようなことが起こり得る

- 保護の範囲についての誤解
- 物品の色彩についての誤解、つまり、色彩が正しく確認されない

Question 2-2 This is a question to the IP Office of any country that has neither a partial design system nor a system to protect the design of a part of an article. If you are representing the IP Office of any country that has either of these systems, please skip this question and answer Question 3.

Do the users of the design system of your country request protection for the partial designs of articles? For example, is there a need for the establishment of a partial design system, which is an effective countermeasure against infringers of partial designs who copy only a unique and innovative part of an article without copying the design of the article as a whole?

Answer Section 2-2

N/A for Turkey.

トルコには該当しない。

Question 3 The policy of conducting to find designs

Please answer this question regardless of whether your country has adopted a system that conducts only formality examination before registration, a system that conducts both formality examination and substantive examination before registration, or a system that conducts formality examination on all applications and conducts substantive examination only on certain applications before registration.

Question 3-1 In the course of formality examination on the design claimed in an application, to what extent do you conduct to find the design? Example answers are listed below. Please give us a detailed answer.

- We examine whether an application satisfies the prescribed formality requirements such as the number, sizes, etc., of the submitted drawings or photographs but do not examine the design in further detail.
- In addition to whether a design satisfies the formality requirements, we conduct to find out whether the design is disclosed in accordance with the relevant regulations by taking into consideration the article that embodies the design and checking the drawings, photographs, etc., submitted by the applicant.
- If we conduct to find design and determine that the design fails to satisfy the substantive requirements for design registration (e.g., the case where the design clearly lacks novelty), we conduct substantive examination as well

Answer Section 3- 1

In the course of formality examination on the design claimed in an application, we examine whether an application satisfies the prescribed formality requirements such as the number, sizes, clarity, etc. of the submitted drawings or photographs, submitted filing forms, and bank receipt but do not examine the design in further detail.

According to the Article 26, an application for registration of a design must be filed with the following:

- a) A petition, the form and contents of which as specified in the Implementing Regulation, including information identifying the applicant,**
- b) A drawing, painting, graphic, photographic or similar representation of the design suitable for reproduction and reflecting all of its specific features.**

The application shall contain a written description of the design and the list of the products in which the design is intended to be incorporated or to which it is intended to be applied.

出願された意匠の方式審査では、提出された図面あるいは写真の枚数、サイズ、提出された出願書式、銀行の領収証など、規定された形式的要件を満たしているかのみを判断し、具体的な意匠の認定は行わない。

第 26 条によれば、意匠登録出願は、次のものと一緒に提出する必要がある。

- a) 意匠規則に規定された、出願人の特定情報を含む、願書、様式および内容**

b) 図面、図案、書画、写真または同様の意匠の表示であって、具体的な特徴のすべてを反映した複製のために適切なもの
出願は、意匠の説明書及び意匠が一体化されるもしくは使用される物品の一覧を含むものとする。

Question 3-2 Who conducts the formality examination mentioned in Question 3-1? Is it conducted by a formality examiner, Office staff member, or any other staff member (including a substantive examiner)? Please specify.

Answer Section 3-2

The formality examination mentioned in Question 3-1 is conducted by a formality examiner wherein a formality examiner can be a specialist or an engineer working in the design department as an Office staff member.

Question 3-1 で述べた法式審査は、方式審査官が行うが、方式審査官は、特許庁の職員として意匠部門に所属する、専門家または技術者である。

Question 3-3 Do you have a system to invalidate a registered design right on the grounds that the design is unclear for such reasons as the design right having an unidentifiable scope? Example answers are listed below. Please give us a detailed answer.

- System to file a request with the IP Office for commencement of examination
- System to file a request with the IP Office for an invalidation trial
- System to file a lawsuit with a court

Answer Section 3-3

We use the system to file a lawsuit with a court to invalidate a registered design right. In case of a lawsuit, the court may decide either to invalidate the registered design or to file a new application instead of the present design to solve the problem.

わが国では、登録意匠権を無効化するには、裁判所への提訴を行う。訴訟では、問題を解決するために、登録意匠を無効にするか、あるいは現在の意匠の代わりに新たな意匠を提出するかを、裁判所が判断する。

Question 3-4 Is there any judicial precedent where the clarity of a design representation was at issue? If yes, please summarize the judgment and tell us the grounds on which the court found the design representation to be unclear.

Section 3-4

Up to our knowledge, there is not a judicial precedent where the clarity of a design representation was at issue.

意匠の表現の明確性が争点になった判例は、我々の知る限りではない。

Question 4 Principle concerning amendments

Question 4-1 Is it permitted to amend a design application? If yes, what restrictions are imposed on an amendment in terms of time schedule and content? Please tell us any restrictions imposed on an amendment in practice other than those specified in the laws, regulations, examination guidelines, etc., that we should know about. Furthermore, is it permitted to make a voluntary amendment?

Answer Section 4-1

Yes, it is permitted to amend a design application. The amendment can be requested by

- **the Office due to a missing or unclear part from the applicant or**
- **the applicant himself can make a voluntary amendment from the Office. The voluntary amendment can be filed until publication.**

If the Office notifies an amendment to the applicant, the notification has a due date for completing the requirements and the application date is not changed due to changes in the application.

If the applicant himself makes a voluntary amendment, then the application date may be changed as the submission date of the amendment according to the Office decision.

意匠出願を補正することは可能。補正を請求できるのは、次の場合である。

- 不足や不明瞭な箇所があるという理由で、庁が出願人に対して請求
- 出願人が自発的に補正を行う。自発的な補正を提出できるのは、公開までである。

庁が出願人に対して補正を通知した場合、この通知には、要件を充足させる期限が設けられるが、出願内容の変更によって出願日が変更されることはない。

出願人の自発的な補正の場合は、庁の判断によって、出願日が補正提出日に変更される場合がある。

Question 4-2 What may be submitted to make an amendment? Please tell us what may be submitted in practice other than those specified in the laws, regulations, examination guidelines, etc.

Answer Section 4-2

If the Office notifies an amendment to the applicant, then the applicant should use the Deficiency Completing Form to submit the amendment. The new documents are also added to this form.

If the applicant himself makes a voluntary amendment, then the applicant can use either an ordinary petition or a Deficiency Completing Form to submit his amendment together with the new documents if there is.

庁が出願人に対して補正を通知した場合、出願人は、「不備修正書」を使用して補正を提出する。新たな書類も、この修正書に添える。

出願人の自発的な補正の場合は、通常の願書または「不備修正書」を使用して、新たな書類があれば、それらも一緒に提出する。

Question 4-3 If the IP Office refuses to accept any amendment made in response to an amendment order or made voluntarily, what action would the IP Office take? Is there a possibility that the IP Office dismisses the design application? Or, if only a minor defect is involved, would the IP Office accept amendment and register the application which was amended?

Answer Section 4-3

If IP Office refuses to accept any amendment made in response to an amendment order or any amendment made voluntarily, the Office then sends another notification regarding the defect, the due date of which is shorter than the prior one and the due dates of the subsequent notifications always continue with a decreasing manner.

There is no possibility that the IP Office dismisses the design application in case of refusing to accept any amendment. The IP Office always sends another notification to provide a complete application. If only a minor defect is involved, the IP Office would accept amendment and register the application which was amended.

補正指令によってなされた補正、あるいは自発的になされた補正が認められなかった場合、庁は、前回よりも短い期限で、不備に関する通知を再度送る。その後も、通知が繰り返されるたび、期限は短くなっていく。

庁が補正を拒絶した場合に、意匠出願を却下される可能性はない。特許庁は、拒絶のたびに、完全な出願を提供するよう、新たな通知を送付する。些細な不備のみの場合、庁は補正を受理し、補正された出願を登録する場合もある。

Question 4-4 Even though a design application is satisfied the formality requirements, are there any cases where the IP Office sends the applicant an instruction for an amendment related to a representation of the design in order to facilitate to conduct finding the design or to make the representation of the design more accurate? Please tell us what is stated in such a request in detail.

Answer Section 4-4

Rather than to facilitate to conduct finding the design, the Office would request additional visuals to make the application more clear and understandable. For that reason, different visuals from different points of view of the design may be requested. In some rare cases, article with the targeted design itself may be requested from the applicant to understand the unclear points.

意匠を認定しやすくするためというより、出願をより明確で理解しやすいものにするという目的で、追加的な図を要求する。そのため、意匠に関するさまざまな観点のさまざまな図が要求される可能性がある。まれなケースだが、不明点を理解するため、出願人に対して、対象の意匠を付した物品そのものの提出が求められることもある。

Question 4-5 In the case mentioned in Question 4-4, if the IP Office sends an instruction to an applicant, is the applicant required to make an amendment strictly in accordance with the instruction? Or, is the applicant permitted to make an amendment in the way he/she wishes to a certain extent? Please explain in detail.

Answer Section 4-5

Yes, the applicant strictly gives his response in accordance with the instruction, otherwise, the application deemed to be withdrawn. The applicant is not free while responding to this kind of instructions.

出願人は、指示通りに応答しなければならず、さもないと、出願を取り下げたとみなされる。この種の指示に応答する際には、自由度はない。

Question 4-6 Is it permitted for a design applicant to divide the application and file a divisional application as a new design application? If we yes, what restrictions are imposed on the filing of a divisional application in terms of time schedule and content? Please tell us any restrictions imposed in practice other than those specified in the laws, regulations, examination guidelines, etc., that we should know about. For instance, is it permitted to divide a design application for a whole article and file a divisional design application for a new part or component?

Answer Section 4-6

Yes, a divisional application can be filed only if the Office requests from the applicant to divide the application. If an application does not meet the requirements of the Article 28 of Decree Law, then it can be divided.

分割出願は、庁が出願人に対して出願を分割するよう要求した場合のみ、可能である。出願が、意匠法第 28 条の要件を満たしていない場合、その出願の分割が可能になる。

According to the Article 28, application of several designs may be combined in one application. However, this possibility is subject to the condition, except in cases of ornamentation, that the products in which the designs are intended to be incorporated or to which they are intended to be applied all belong to the same sub-class or to the same set or composition of items. Additionally, the compound products, which has components changeable by assembly and disassembly or renewable (for example a pen and its cover), could be filed in one application.

第 28 条によれば、複数の意匠の出願を組み合わせて、1 件の出願にすることができる。ただし、この可能性は、装飾の場合を除き、意匠が一体化されもしくは使用される物品がすべて同一の副分類または同一の組物もしくは構成物品に属することを条件とする。また、組み立てや分解

によって部品を交換可能、または再生可能な複合物品（例えば、ペンとそのカバー）は、一件の出願として提出することができる。

Question 4-7 Before the according of the application filing date, is it necessary for the applicant to satisfy the requirements for representation of a design and a design should be found? Or, may the application filing date be accorded without finding a design as long as the formality requirements are satisfied (e.g., the number and size of drawings or photographs)?

Answer Section 4-7

According to the Article 26, an application for registration of a design must be filed with the following:

a) A petition, the form and contents of which as specified in the Implementing Regulation, including information identifying the applicant,

b) A drawing, painting, graphic, photographic or similar representation of the design suitable for reproduction and reflecting all of its specific features.

The application shall contain a written description of the design and the list of the products in which the design is intended to be incorporated or to which it is intended to be applied.

If the above mentioned formality requirements are satisfied then the filing date is accorded without finding a design. Otherwise, i.e. if either of them is not satisfied then the filing date is not accorded until it is satisfied.

第 26 条によれば、意匠登録出願は、次のものと一緒に提出する必要がある。

a) 意匠規則に規定された、出願人の特定情報を含む、願書、様式および内容

b) 図面、図案、書画、写真または同様の意匠の表示であって、具体的な特徴のすべてを反映した複製のために適切なもの

出願は、意匠の説明書及び意匠が一体化されるもしくは使用される物品の一覧を含むものとする。

上記の形式的な要件が満たされれば、意匠が認定されなくても、出願日が認定される。満たされていない場合は、満たされるまで出願日は認定されない。

Question 4-8 In the case specified in Question 4-7, after an applicant makes an amendment in response to an order for amendment that the IP Office issued on the grounds that the requirements for according the application filing date were not satisfied, if said requirements are satisfied as a result of the amendment, which date does the IP Office accord as the application filing date, either the first application filing date or the date on which the amendment was submitted?

Answer Section 4-8

If a drawing, painting, graphic, photographic or similar representation of the design suitable for reproduction and reflecting all of its specific features is missing at the application stage and they are submitted later, then the according date will be the date of this submission or amendment.

Or, if the amendment will be about the number and size of drawings or photographs, then the first application date will be the according date of the design.

図面、図案、書画、写真または同様の意匠の表示であって、具体的な特徴のすべてを反映した複製のために適切なものが出願段階で不足していて、後に提出された場合、その提出または補正の日が出願日として認定される。

あるいは、補正が図面や写真の数やサイズに関するものである場合は、最初の出願日が意匠出願日として認定される。

Question 4-9 In the case of an IP Office that conducts to find a design as a prerequisite for according the application filing date, please answer this question. In the case of any other IP Office, please skip this question and answer Question 5.

In the case mentioned in Question 4-8, if an amendment submitted to the IP Office changes the gist of the design, how would the amendment be treated? Would it be dismissed? Or, would it be deemed as a new application filed on the date on which the written answer to the order for amendment is submitted? Please explain in detail.

Answer Section 4-9

N/A

Question 5 Principle of unity

Question 5-1 Please tell us the requirements for representations of designs in order for multiple designs to be regarded as a single design.

Please give us a detailed answer. For example, is it the case that the designs of articles that are used in a physically separated manner may be regarded as a single design as long as those designs are regarded as a set in terms of design (e.g., a set of stackable pans), that a set of similar designs may be regarded as a single design as long as those designs are similar to each other in terms of configuration¹, that the designs represented in a drawing in a physically

¹ “Configuration” means here that the shape, patterns or colors, or any combination thereof, of an article. The same shall apply hereinafter.

separated manner may be regarded as a single design as long as those articles are used simultaneously (e.g., a pen and its cap), or that the designs of different articles may be regarded as a single design as long as they are used simultaneously (e.g., a stationary article and its base)? Which requirements, either formality requirements (formality examination) or substantive requirements (substantive examination), must be met in order to recognize multiple designs as a single design? If multiple designs are not regarded as a single design, how would the IP Office treat them?

(Example) In Japan, a design application would be dismissed (i) if the applicant states two or more classifications of articles in the section entitled "Article which constitutes the design" of an application, (ii) if the applicant presents drawings of two or more articles, or (3) in the case of an application for the design of a part of an article, if the application covers two or more physically separated parts. If an application is dismissed for any of the aforementioned reasons, the applicant may file a divisional application (substantive requirements).

Answer Section 5-1

According to the Article 9 paragraph 6 of the Industrial Design Implementation Regulation: "Additional visual expression is an appearance provided from different point of view of the design on the condition that shall not disrupt the integrity of the design to better understand the design. Also, different views that reflecting usage features of the design are considered as additional visual expressions."

意匠規則第 9 条(6)では次のように定めている。「追加的な視覚表現は、異なる視点から見た意匠の外観であるが、意匠をより正しく認識するため、当該意匠の全体性を阻害しないことを条件とする。また、意匠の使用における特徴を反映した図も、追加の視覚表現と見なされる」

As there are no direct rules or articles, we should use the implementation ways of the applications in Turkey. The following examples explain the representations of designs in order for multiple designs to be regarded as a single design:

トルコでは直接的な規則や条項がないため、出願の実施規則を使用する必要がある。複数の意匠が一意匠と認められるための、意匠の表現について説明する。

Example 1 (see Enclosure 2 about a pen and its cap): If the physically separated parts of the multiple designs are connected, the connected appearance can be filed as a single design (see figure 1), although they do not belong the same sub-class, any additional view should be single unit but not disintegrated. On the other hand, if the visual presentations are consisted of two or more separate parts (disintegrated as in Figure 2), then they are regarded as multiple designs.

例 1 (Enclosure 2 : ペンとキャップ) : 物理的に離れている部分どうしが連結される場合、連結された外観は一意匠として出願できる (図 1 参照)。ただし、両者は同一の副分類に属しておらず、追加の図は一体で、分解されていない必要がある。

Example 2 (see Enclosure 3 about a bathroom cabinet): Recently, the TPI accepts the designs having

two or more separated parts. In the example, there is an application having one image which shows 3 different and separated parts that forms a bathroom cabinet. This design is applied as a single design. These kinds of designs are identified as representation (practice) form of a design, i.e. the design shows the use or position of the design after set in place.

例 2 (Enclosure 3 : バスルーム・キャビネット) : トルコ特許庁は最近、2 つ以上の離れた部分を有する意匠を認めた。この例の出願には、バスルーム・キャビネットを形成する、異なる 3 つの離れた部分を示す画像がある。この意匠は一意匠として出願されている。こうした種類の意匠は、意匠の表示 (実用) 様式と認識される。すなわちこの意匠は、その使用または配置後の位置を示している。

Question 5-2 This is a question to the IP Office of any country that protects images. If your country does not protect images, please skip this question and answer Question 6.

Please tell us the provisions concerning representations of drawings that are required to be made in order to have multiple images regarded as a single design. Which requirements, either formality requirements (formality examination) or substantive requirements (substantive examination), must be met in order to have multiple images regarded as a single design? If multiple images are not regarded as a single design, how would the IP Office treat them?

(Example) In Japan, multiple images may be regarded as a single design covering multiple images in the case where the image before a change and the image after the change are used in relation to the same function of an article as long as those two images are considered to be related to each other in terms of configuration. If multiple images are not regarded as a single design, the application would be dismissed on the grounds that multiple images should be regarded as multiple designs (substantive requirements).

Answer Section 5-2

Please refer to previous answer.
5-1 の回答を参照。

Question 6 Scope of design protection

Question 6-1 Based on what definitions or ideas concerning the similarity of the configurations of designs do you determine the scope of design protection? Please give us any judicial precedent where the court presented its interpretation about how to interpret the scope of design protection from the perspective of configuration similarity, for example, whether the scope of design protection only covers almost identical designs or covers designs of different degrees of similarity (variations).

No judicial precedent is available for us. In determining the scope of protection, Articles 11 and 7 of Decree Law are used.

判例はない。意匠権の効力の及ぶ範囲を判断する際は、意匠法第 11 条および第 7 条が適用される。

Article 11 - In determining the scope of protection all designs which produce on the informed user a significantly similar overall impression in conformity with Article 7 shall be taken into consideration.

In determining the scope of protection, common features shall be given more weight than differences and the degree of freedom of the designer in the development of the design shall be taken into consideration.

第 11 条－実施当事者に対して第 7 条に則して顕著に類似の総合的印象を与える意匠はすべて、保護の範囲が決定される場合に検討対象にされるものとする。

保護の範囲を決定する場合は、相違点よりも一般的特徴に重点が置かれるものとし、意匠の作成における創作者の自由度も斟酌されるものとする。

Article 7 - A design shall be understood to have an individual character if the overall impression it creates on the informed user is significantly different from the overall impression created on the same user by any design referred to in the second paragraph of this Article.

第 7 条－意匠が固有の特性を有するとみなされるのは、意匠が実施当事者に与える総合的印象が、第 2 段落にいう何れかの意匠により当該実施当事者に与えられる総合的印象に比べ相違が顕著である場合であるものとする。

In order for any other design to be compared for the purposes of determining the individual character of a design;

a) It should have been made public in Turkey or in the world before the application date.

b) It should have been published by the Institute as a registered design, and that the protection period has not expired at the application date of the design with which it shall be compared.

意匠の固有の特性を決定するために、比較目的で使用されるその他の意匠については、

(a) 当該意匠が、出願日前に、トルコまたは世界で公開済であるものとする。

(b) 当該意匠が、登録意匠として庁により公告済であるものとし、当該保護期間が、比較対象である意匠の出願日に満了済でないものとする。

In the assessment of the individual character, the emphasis of evaluation shall be on the common features of the designs and the degree of freedom of the designer in developing the design shall also be taken into consideration.

固有の特性が決定されるに当たっては、意匠の一般的特徴に重点が置かれるものとし、意匠の作

成における意匠創作者の自由度も併せて斟酌されるものとする。

Question 6-2 Please explain in detail how the scope of design protection is affected by the identity or similarity of articles or by the identity or similarity of the functions and use of articles. Please give us any judicial precedent where the court presented its interpretation as to how the scope of design protection is affected by these factors.

Answer Section 6-2

Please refer to previous answer.

Section 6-2 の回答を参照。

Question 6-3 Please explain in detail how the scope of design protection is affected by the parts of an article that are not represented in drawings or photographs.

Answer Section 6-3

As they are not represented in drawings or photographs, they are not included in the scope of the protection and therefore the scope of design protection is not affected from them.

図面や写真に表されていないため、保護の範囲には含まれず、したがって、そうした箇所によって意匠保護の範囲が影響を受けることはない。

Question 6-4 In the case of a design right for an article which partially changes to perform its functions, does the scope for design protection cover the configurations observed in the course of change? Or, does the scope of design protection cover only the configuration before a change and the configuration after the change?

The following is a specific example where a part of an article (toy) that has a three-dimensional configuration changes its configuration to perform its functions.

[Front view]



[Rear view]

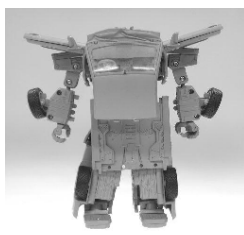

[Left side view]



[Right side view]

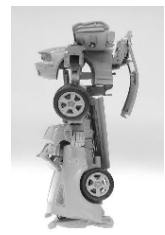

[Top view]



[Bottom view]



[Perspective view of the changing configuration]



[Front perspective view after the change]



[Rear perspective view after the change]



Answer Section 6-4

Yes, the scope for design protection covers the configurations observed in the course of change according to the Article 9 paragraph 6 of the Industrial Design Implementation Regulation: “Additional visual expression is an appearance provided from different point of view of the design on the condition that shall not disrupt the integrity of the design to better understand the design. Also, different views that reflecting usage features of the design are considered as additional visual expressions.”

意匠の効力は、変化の過程における形態にも及び、意匠規則第9条(6)では次のように定めている。「追加的な視覚表現は、異なる視点から見た意匠の外観であるが、意匠をより正しく認識するため、当該意匠の全体性を阻害しないことを条件とする。また、意匠の使用における特徴を反映した図も、追加の視覚表現と見なされる」

Question 6-5 This question is about the scope of design protection in the case of a set of articles or a certain set of articles. Does the design protection only cover a set of articles or a certain set articles? Or, does the design protection also cover each article that comprises a set?

If simultaneously used multiple articles are coordinated as a whole, the designs of those articles may be regarded as a single design. Such a design may be regarded as a "design for a set of articles." The term "a design for a certain set of articles" is conceptually the same as "a design for a set of articles." The term "a design for a certain set of articles" refers to a design used for any of the prescribed types of set.

Answer Section 6-5

Design protection covers each article of a set separately because each of the articles should be filed in different visuals one by one. The applicant cannot file a visual that shows the all of the articles in the same picture as a set. For example; a bedroom set comprising a bed, a wardrobe, a dresser, a mirror, a nightstand etc. (see Enclosure 4)

意匠保護は、セットの各物品に及ぶ。というのも、各物品は、1 つずつ異なる図で提出する必要があるためである。すべての物品を、セットとして同一の図に示すことはできない。例として、ベッド、衣装タンス、化粧台、ナイトテーブルなどからなるベッドルームのセットがある (Enclosure 4 を参照)。

Question 6-6 This is a question about the restrictions on the exercise of design rights that are related to each other in conflict of which both right holders and both filing dates are deferent.

Design rights are considered to be related to each other in conflict in the following three cases:

- (i) a design right to protect the design of a whole article and a design right to protect the design of a component of the article (the component can be regarded as an independent article). Filing date of the design right of a component of the article is earlier than filing date of the design right of a whole article. Both rights are owned by deferent persons;
- (ii) a design right to protect the design of a whole article and a design right to protect the design of a part of the article (a part means a portion of the article and cannot be separated as a component). Filing date of the design right of a part of the article is earlier than filing date of the design right of a whole article. Both rights are owned by deferent persons; and
- (iii) a design right to protect the design of a set of articles or a certain set of articles and a design right to protect the design of any article that

comprises a set. Filing date of the design right of any article that comprises a set is earlier than filing date of the design right of a set of articles or a certain set of articles. Both rights are owned by deferent persons.

For example, in Case (i) above, if the holder of a design right to protect the design of a whole article works the design or exercises the design right, is it sometimes necessary for him/her to obtain a license from the holder of a design right to protect the design of a component? How about the situations in Case (ii) and Case (iii) described above in terms of the restrictions on the exercise of design rights?

Answer Section 6-6

According to the Article 17 “The holder of the design right has exclusive rights with respect to the use of the design. Third parties, without the consent of the design right holder, cannot produce, put on the market, sell, offer, import, put to commercial use or keep in stock for this purposes the product in which such a design is incorporated or to which it is applied.”

Therefore for all three situations above, the holder of the substantive application should request the permission of the holder of the prior application to use his/her design.

第 17 条は次のように規定している。「意匠権者は、意匠の実施に係る排他的権利を有するものとし、第三者は、当該意匠が一体化されているもしくは使用されている物品を、意匠権者の承諾なしに、生産、市場化、販売、販売の申出、輸入、商品化するまたはそれらの目的で在庫保持することができない」

したがって、上記の 3 つのケースすべてにおいて、後に出願した意匠権者は、先に出願した意匠権者の意匠を使用する許可を求める必要がある。

Question 6-7 This is a question to the IP Office of any country that protects multiple images as a single design.

If your country does not protect multiple images as a single design, please skip this question and answer Question 7.

In the case of two related design rights, i.e., a design right to protect the designs of multiple images and a design right to protect the design of any of those images, are in conflict. Filing date of the design right of any of those images is earlier than filing date of the designs right of multiple images. Both rights are owned by deferent persons. In this case, are any restrictions imposed on the exercise of those design rights?

Answer Section 6-7

Except the examples given in Answer Section 5-1, our country does not protect multiple images as a single design.

Section 5-1 で挙げた例を除き、わが国では複数の画像は一意匠として保護されない。

Question 6-8 This is a question to the IP Office of any country that protects multiple images as a single design and conducts substantive examination. If your country does not protect multiple images as a single design and does not conduct substantive examination, please skip this question and answer Question 7.

In case of an application seeking for a protection of a design of multiple images when the filing date of an application seeking for a protection of design of any of those images is earlier than the filing date of an application seeking for a protection of a design of multiple images, and both applicants are different, what measures do you take when determining whether such a design has novelty and is not easily creatable by any person skilled in the art?

Answer Section 6-8

N/A (substantive examination is not conducted in Turkey)

トルコでは実体審査は実施していない。

Question 7 Disclosure by drawings included in application documents and publication by gazettes

Question 7-1 Are there any cases where a drawing or photograph included in application documents is edited (e.g., altered in size or ratio) when the design is publicized in a design gazette (including an electronic gazette)? If editing is conducted, please tell us the reasons and standards for editing.

Answer Section 7-1

A drawing or photograph included in application documents is not edited (e.g., altered in size or ratio) when the design is publicized in a design gazette because the applicants should file a drawing or a photograph in standard sizes of which is 8x8, 8x16 or 16x16 cm. The publication of a drawing or a photograph is made in their actual sizes.

出願書類に含まれる図面や写真は、8x8 cm、8x16 cm、16x16 cm の標準的なサイズで提出する必

要があるため、公報掲載時に加工（サイズや比率の変更）は行わない。図面や写真は実際のサイズで掲載される。

Question 7-2 If a design application is filed by an electronic medium, do you store printed-out hardcopies of the representations of the design as the original documents in addition to the submitted electronic images of those representations? If yes, why?

Answer Section 7-2

Yes, if a design application is filed by an electronic medium, we store printed-out hardcopies of the representations of the design as the original documents in addition to the submitted electronic images of those representations because of safety and facilitating purposes.

For example most of the applications are made by hard copies and they are also moved in electronic medium to store them in both ways so that they can be easily used for publication.

意匠出願が電子媒体による場合、安全・円滑化の目的で、電子媒体の記録以外に、意匠の表現物をプリントアウトしたハードコピーも原本として保管している。

また、出願のほとんどはハードコピーで行われるが、これらを電子媒体化し、両方の形式で保管し、公開においても容易に使用できるようにしている。

Question 7-3 Does the public have access to the documents (including electronic data) prepared in the course of design prosecution starting from the filing of a design application to the registration of the design? If yes, please tell us the inspection fee and conditions (to what extent is inspection permitted? Are there any documents that are not available for inspection?).

Answer Section 7-3

The public have two types of access without an inspection fee;

- **The public have access to the basic application info (filing no, date, applicant only) without the design visuals (from the online services of Turkish Patent Institute) prepared in the course of design prosecution starting from the filing of a design application to the publication of the design.**
- **In addition to basic application info, the public also have access to the design visuals, inventors and representing agent info (from the online services of Turkish Patent Institute) prepared in the course of design prosecution starting from the publication of a design application to the termination of the design registration.**

手数料のかからない2通りの閲覧の方法がある。

- 意匠出願の提出から、意匠の公開までの意匠権利化手続きの過程で作成された、意匠の表示を含まない、出願基本情報（出願番号、日付、出願人のみ）の閲覧（トルコ特許庁のオンラインサービス）
- 出願基本情報に加えて、意匠出願の公開から、意匠登録の終了までの意匠権利化手続きの過程で作成された、意匠の表示、発明者および代理人の情報の閲覧（トルコ特許庁のオンラインサービス）

Question 8 Do you receive any opinions from users of the design system such as a request for a revision of the design system in order to change the way of representing a design in a design application under the relevant laws, regulations, and examination guidelines of your country and to remedy the current situation where the way of representing a design differs from one country to another? If yes, please describe those opinions in detail.

Answer Section 8

The most repeated complaints/opinions/requests from users of the design system are as follows;

- **The lack of substantive examination to find the similar designs; lack of laws regarding the examination causes a) long publication period (6 months), and b) third parties to follow the publication of designs themselves.**
- **TPI requests additional publication fees for the additional views. On the other side, OHIM does not request publication fees for the additional views up to 7 views.**

意匠制度ユーザーからの苦情／意見／要望として最も多いのは次の通りである。

- 類似意匠を認定する実体審査がない。審査に関する法律がないため、a) 公開期間が長く（6カ月）、b) 第三者が自ら意匠の公開をフォロー（???) している。
- 追加の図に対して、追加手数料が請求される。OHIMでは、図の追加は7つまでは追加手数料がかからない。

Question 9 In recent years, has the number of design applications been on the rise or on the decline? What do you think has caused such increase or decrease?

Answer Section 9

The number of design applications has been on the rise in recent years, because;

- **Government started to pay incentive fees for design application in recent years,**
- **Turkey has signed the Geneva Act of Hague Agreement Concerning The International**

Registration Of Industrial Designs on 01.01.2005 so that international applications can be filed through TPI in Turkey,

- **Consciousness of the producers and designers are increases in time.**

近年、意匠出願件数は増加傾向であり、次のような要因がある。

- 近年、政府が意匠出願の奨励金の支給を始めたこと
- 2005年1月1日に、意匠の国際登録に関するヘーグ協定ジュネーブ・アクトに調印し、トルコ特許庁を介して国内で国際出願ができるようになったこと
- 製造業者や意匠創作者の意識が次第に高まってきたこと

Question 10 If your country has signed the Hague agreement, please answer this question. Did the number of design applications increase or decrease in your country before and after the signing of the Hague agreement?

Answer Section 10

Turkey has signed the Hague agreement in 2004 and it is affected as from 01.01.2005. The design applications increase after the signing of the Hague agreement in Turkey. Yes the Hague agreement caused an increase in design applications.

ヘーグ協定は2004年に調印され、2005年1月1日に発効した。ヘーグ協定調印後、トルコにおける意匠出願件数は増加した。ヘーグ協定が意匠出願件数増加の要因であるのは確かである。

Question 11 If your country has signed the Hague agreement, please skip this question and answer Question 12.

This is a question to the IP Office of any country that is planning to sign the Hague agreement. What are your purposes for signing the Hague agreement? Please describe your purposes in detail.

Answer Section 11

N/A

Question 12 Please answer this question if your country has signed the Hague agreement or is planning to do so. In order to sign the Hague agreement, did you have to make any alterations or adjustments to your country's system? Or, is your country planning to alter or adjust your country's system in the future?

Answer Section 12

When Turkey signed the Hague agreement, no alterations or adjustments was required to be applied in our country's design practice.

トルコがヘーグ協定に調印した際は、意匠制度の運用を変更や調整の必要は一切なかった。

[Request for information]

13 If your country has adopted a multiple design application system, please send us information on how an application and drawings should be prepared in order to file a multiple design application. We would appreciate if you could send us a sample application and a sample drawing that are available for disclosure (those with all the sections filled in with information as a sample). If such application and drawing are not available for disclosure, please send us a blank application form, etc., if possible.

Please refer to **Enclosure 5** for sample petition, **Enclosure 6** for sample visual representation (8x16 cm) and **Enclosure 7** for sample description page of a multiple design application in Turkey.

Enclosure 5 はトルコにおける願書のサンプル、Enclosure 6 は視覚表示（8x16 cm）のサンプル、Enclosure 7 は多意匠一出願の記載のサンプルである。

14 Is it possible for you to send us a sample registration certificate? Again, we would appreciate if you could send us such a certificate with all the sections filled in with information as a sample. If such certificate is not available for disclosure, please send us a blank certificate form, if possible.

Please find enclosed a sample registration certificate (**Enclosure 8**).

登録証のサンプル (**Enclosure 8**) を添付。



T.C.
TÜRK PATENT ENSTİTÜSÜ

TASARIM TESCİL BELGESİ

TESCİL NUMARASI : 2011 06981

Bu belge ekinde yer alan tasarımlar, 18/11/2011 tarihinde tescil edilmiş olup 554 Sayılı Endüstriyel Tasarımların Korunması Hakkında Kanun Hükmünde Kararname'nin 12 nci maddesi gereğince 5 yıl süre ile korunmaktadır. İşbu belge 22/10/2012 tarihinde düzenlenmiştir

Naim UĞUR

Enstitü Başkanı a.

Endüstriyel Tasarımlar Dairesi Başkanı



ENDÜSTRİYEL TASARIMLAR DAİRESİ BAŞKANLIĞI

ENDÜSTRİYEL TASARIM SİCİLİ

BAŞVURU BİLGİLERİ

Başvuru Numarası	: 2011/06981	Başvuru Tarihi	: 18/11/2011
Tescil Numarası	: 2011 06981	Tescil Tarihi	: 18/11/2011
Başvuru Çeşidi	: Çoklu	Tasarım Sayısı	: 3
Bülten Numarası	: 192	Bülten Tarihi	: 01/04/2012

BAŞVURU SAHİBİ

Soyad / Unvan	: PETAINER LIDKÖPING AB
Ülkesi	: İSVEÇ KRALLIĞI
Adres	: Box 902 SE-53119 Lidköping İSVEÇ

TASARIMLAR

Tasarım Adı - Tasarım Sıra Numarası	Durumu	Tsr. Sys.	Lokarno Sınıf
1-Varil (Konteyner) - 1,2,3	Tescilli	3	09-02

TASARIMCI

ANISLAV CHURY - 1, 2, 3
Primoenici 6 350 02 Cheb ÇEK CUMHURİYETİ

AVUKAT

AY YASEMİN ÖZLÜK (DESTEK PATENT A.Ş.)
KARIS PLAZA AHI EVRAN CAD. NO:1 KAT:17 D:70 MASLAK/İSTANBUL

ULUSLARARASI BAŞVURUYA DAYALI RÜÇHANLAR

3 sıra numaralı tasarımların tescili için ilk defa 20.05.2011 tarihinde müracaat edildiği OHİM sınai mülkiyet idaresinin 001866997 sayılı belgesinden anlaşılmış olup 20.05.2011 tarihinden itibaren rüçhan hakkı haizdir.

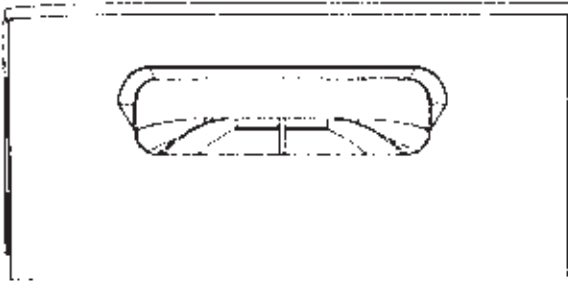

2011 06981

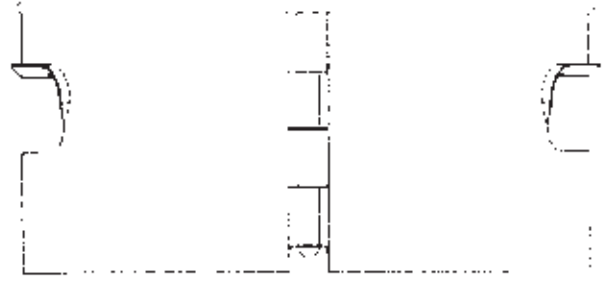

1.1 Fiçı-Varil (Konteyner)

1.2 Fiçı-Varil (Konteyner)

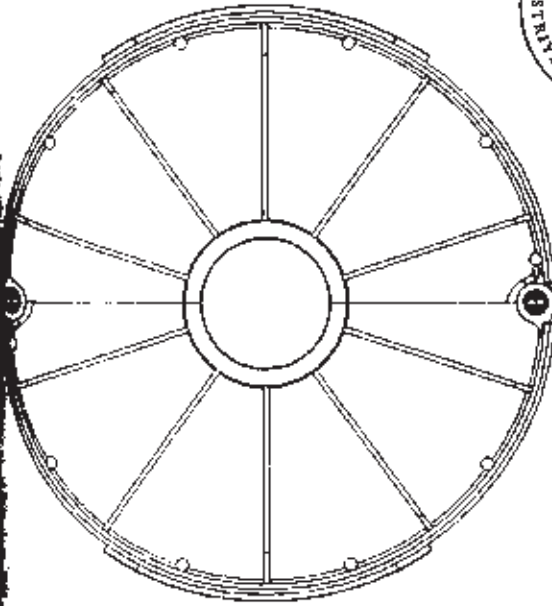

2011 06981

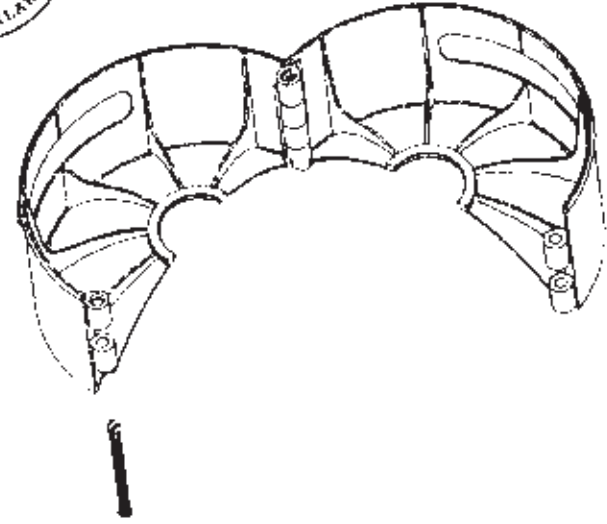

1.3 Fiçı-Varil (Konteyner)

1.4 Fiçı-Varil (Konteyner)

ENDÜSTRİYEL TASARIMLAR DAİRESİ BAŞKANLIĞI

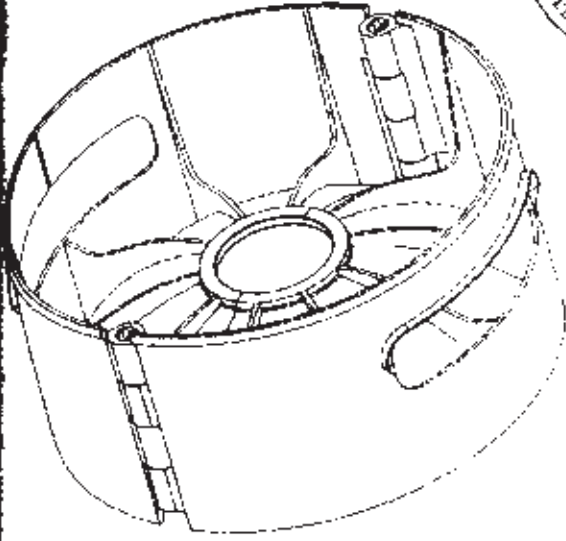

1.5 Fiçı-Varil (Konteyner)

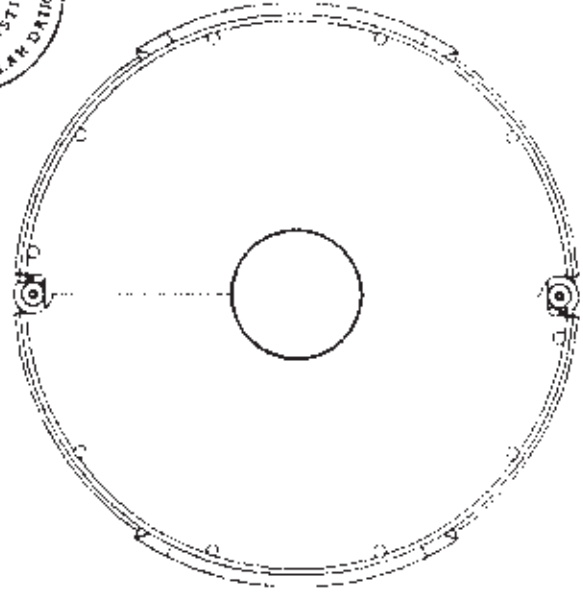

1.6 Fiçı-Varil (Konteyner)

2011 06981

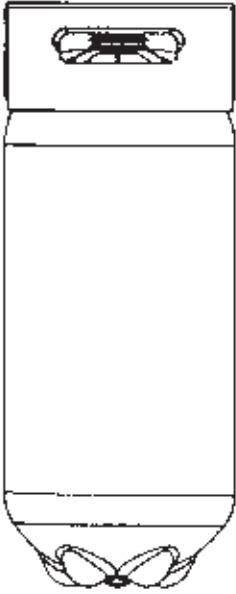
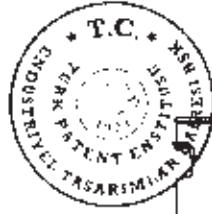

2.1 Fiçı-Varil (Konteyner)

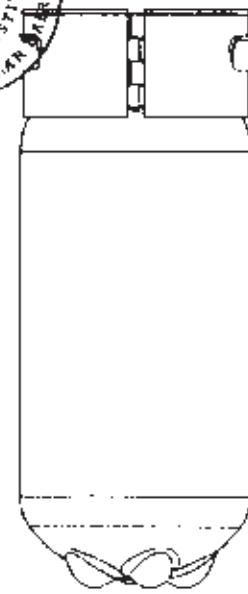

2.2 Fiçı-Varil (Konteyner)

2011 06981

TÜRK PATENT [] ENSTİTÜSÜ

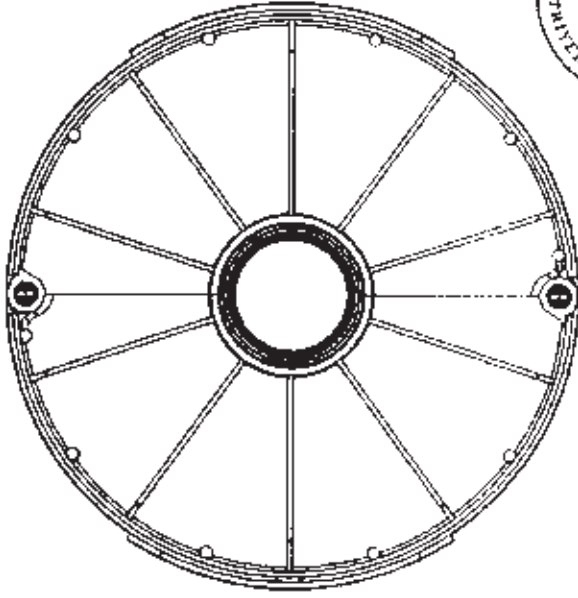

2011 06981

2.3 Fıçı-Varil (Konteyner)

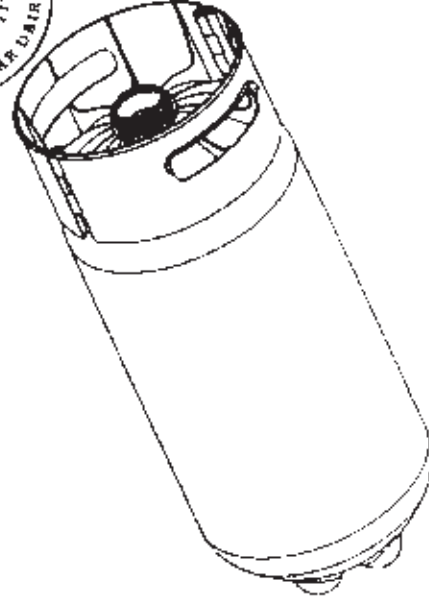

2011 06981

2.4 Fıçı-Varil (Konteyner)

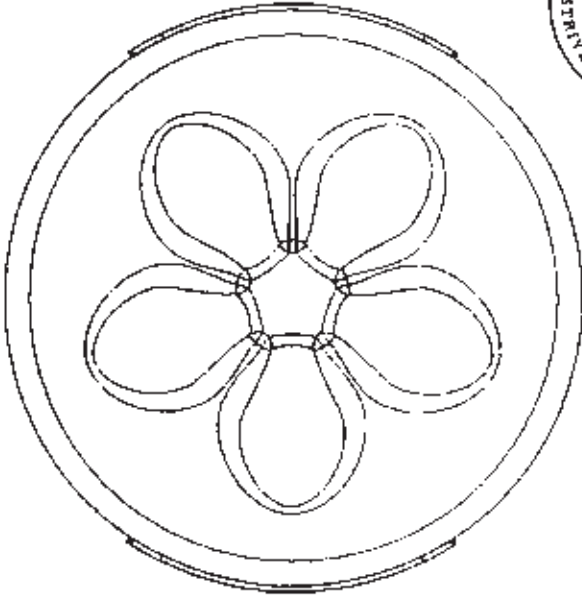

2011 06981

2.5 Fıçı-Varil (Konteyner)

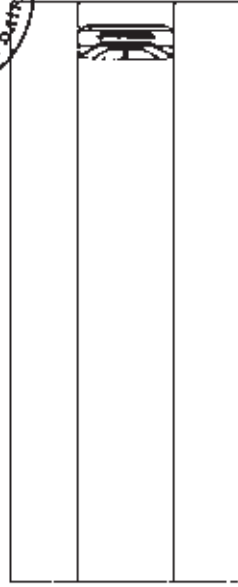

2011 06981

3.1 Fıçı-Varil (Konteyner)



ENDÜSTRİYEL TASARIM TESCİLİ BAŞVURU FORU

Başvuranın referans numarası:	TT2012-00099
-------------------------------	--------------

I. BAŞVURU SAHİBİ	Özel kişi <input type="checkbox"/>	Tüzel kişi <input checked="" type="checkbox"/>	TPE Sahip No (*)	205592
Adı Soyadı (Özel Kişi)				
Uyruğu	T.C.	TC. Kimlik No		
Ünvanı (Tüzel Kişi)	KEVSER ŞEKERLEME GIDA VE İHTİYAÇ MADDELERİ OTOMOTİV TEKSTİL İTHALAT İHRACAT SANAYİ VE TİCARET LİMİTED ŞİRKETİ			
Nev'i	LTD. ŞTİ.	Kayıtlı Olduğu Ülke	TÜRKİYE	
Vergi Dairesi	SELÇUK	Vergi Numarası	5480057656	
Adres	Yeni Şekerciler Sit. Adana Çevre Yolu Özkafa Sok. No:7			
Semt	KARATAY			
İl	KONYA	Posta Kodu		
Telefon Nmr.	(332) 342 29 30	Faks Nmr.		
Yazışma Adresi	Yeni Şekerciler Sit. Adana Çevre Yolu Özkafa Sok. No:7 PK:42030 KARATAY KONYA TÜRKİYE			

II. VEKİL	Var: <input checked="" type="checkbox"/>	Yok: <input type="checkbox"/>	Vekil Sicil No (**)	1000
Adı Soyadı	İlkay Yasemin ÖZLÜK			
Firma Ünvanı	Destek Patent Anonim Şirketi			
Adres	Ahi Evran Caddesi Polaris Plaza No:21 Kat:17 MASLAK			
Semt	MASLAK	İlçe		
İl	İSTANBUL		Posta Kodu	
Telefon Numarası	(312) 444 43 44	Faks Numarası	(312) 219 19 89	
Vekaletname	Ektedir: <input type="checkbox"/>	TPE de bulunmaktadır: <input checked="" type="checkbox"/>	Vekaletname Kayıt No(***)	2009/4433

III. BAŞVURU ÇEŞİDİ	Tekli: <input type="checkbox"/>	Çoklu: <input checked="" type="checkbox"/>	Tasarım Sayısı	2
IV. YAYIN ERTELEME TALEBİ	Var: <input type="checkbox"/>	Yok: <input checked="" type="checkbox"/>	Var İse Süre (Ay Olarak)	
V. RÜÇHAN TALEBİ	Var: <input type="checkbox"/>	Yok: <input checked="" type="checkbox"/>		

Bu başvuruda sunulan tasarım(lar)ın 554 sayılı KHK'nın 6 ncı maddesinde belirtilen "yenilik" şartını karşıladığını beyan ederim.

Adı Soyadı	Tarih	İmza
İlkay Yasemin ÖZLÜK	23.01.2012	

(*) TPE tarafından önceki başvuruda verilmiş olan sahip numarasıdır.

(**) TPE tarafından vekil için verilen sicil numarasıdır.

(***) TPE ye önceden verilen vekaletnamenin kayıt numarasıdır.

ENDÜSTRİYEL TASARIM TESCİLİ BAŞVURU FORMU

VI. TASARIMIN UYGULANACAĞI ÜRÜN(LER)		
Sıra No	Ürün Adı	Locarno Sınıf Kodu
1	AMBALAJ DESENİ	32 00

VII. TASARIMCI(LAR)	
Adı Soyadı	ÖMER ÇEÇEN
Adresi	Yeni Şekerciler Sit. Adana Çevre Yolu Özkafa Sok. No:7 KARATAY KONYA TÜRKİYE
Tasarımlar	

VIII. TASARIM HAKKI

ÖMER ÇEÇEN			
Hizmet İlişkisi	<input checked="" type="checkbox"/> Sözleşme Gereği	<input type="checkbox"/> Devir İntikal Yoluyla	<input type="checkbox"/>
Diğer	<input type="checkbox"/>		

IX. RÜÇHAN BİLGİLERİ		Bütün tasarımlar için aynı rüçhan talebi vardır: <input type="checkbox"/>	
Uluslar arası anlaşmaya dayalıdır :		Sergide Teşhir Hakkından Doğan :	
Rüçhana Esas Başvurunun Yapıldığı;		Serginin;	
Ülke		Sergi Adı	
Tarih		Yeri ve Tarihi	
Başvuru No		İlk Teşhir Tarihi	

Başvuruda tasarımın örneği (numune) verilmiştir : Adı Soyadı
İlkay Yasemin ÖZLÜKTarih
23.01.2012İmza

ENDÜSTRİYEL TASARIM TESCİLİ BAŞVURU FORMU

GÖRSEL ANLATIM SAYFASI

TT2012-00099

Tasarım No: 1	Resim No: 1	Tasarım No: 1	Resim No: 2
---------------	-------------	---------------	-------------



Tasarım No: 2	Resim No: 1	Tasarım No: 2	Resim No: 2
---------------	-------------	---------------	-------------



Adı Soyadı İ.Yasemin ÖZLÜK	Tarih 18.04.2012	İmza
-------------------------------	---------------------	------



ENDÜSTRİYEL TASARIM TESCİLİ BAŞVURU FORMU

TARİFNAME SAYFASI

TT2012-00099

Tasarım No	1	Görünüm Sayısı	1
<p>Ambalaj deseni düz zemin üzerine uyarlanmış, lale motifi şeklindeki büyük şeffaf yüzeye dizayn edilmiştir. Şeffaf kısmın alt tarafına, sema yapan semazen figürü uyarlanmıştır. Üst orta kısma da içerisinde marka ibaresi yer alan elips şeklinde amblem uyarlanmıştır. Bu amblemin etrafı ve alt kenar elips şeklinde yaprakları olan ferforje tarzında kavisli dallarla hareketlendirilmiştir. Yüzeyin dış kenarı, üzerine minik çiçekler sıralanan ve köşe kısımlarda oval formla yuvarlatılan dikdörtgen bordürle çevrelenmiştir.</p>			
Tasarım No	1	Görünüm Sayısı	2
<p>Şekil 1-1 sıra nolu tarifte bahsedilen desenin arka yüzü, düz zemin üzerine uyarlanmış, lale motifi şeklindeki büyük şeffaf yüzeye dizayn edilmiştir. Şeffaf kısmın alt tarafına, tepesi kubbe şeklinde yukarıya doğru sivri, silindirik bir yapı uyarlanmıştır. Üst orta kısma da içerisinde marka ibaresi yer alan elips şeklinde amblem uyarlanmıştır. Bu amblemin etrafı ve alt kenar elips şeklinde yaprakları olan ferforje tarzında kavisli dallarla hareketlendirilmiştir. Yüzeyin dış kenarı, üzerine minik çiçekler sıralanan ve köşe kısımlarda oval formla yuvarlatılan dikdörtgen bordürle çevrelenmiştir.</p>			
Tasarım No	2	Görünüm Sayısı	1
<p>Ambalaj deseni düz zemin üzerine uyarlanmış, sivri elips şeklinde yaprakları olan sapsız çiçek motifi şeklindeki büyük şeffaf yüzeye dizayn edilmiştir. Sarı ve turuncu renk geçişleriyle hareketlendirilen zeminin sol tarafına palmye ağacı uyarlanmıştır. Sol üst köşe kısmında da içerisinde marka ibaresi yer alan elips şeklinde amblem yer almaktadır. Alt kenar, zemin üzerine kalın formla yerleştirilen, şehir silüetiyle hareketlendirilmiştir.</p>			
Tasarım No	2	Görünüm Sayısı	2
<p>Şekil 2-1 sıra nolu tarifte bahsedilen desenin arka yüzü, düz zemin üzerine uyarlanmış, oturur vaziyette deve şeklindeki büyük şeffaf yüzeye dizayn edilmiştir. Sarı ve turuncu renk geçişleriyle hareketlendirilen zeminin sol tarafına palmye ağacı uyarlanmıştır. Sol üst köşe kısmında da içerisinde marka ibaresi yer alan elips şeklinde amblem yer almaktadır. Alt kenar, zemin üzerine kalın formla yerleştirilen ve üzerinde develer ilerleyen minik dağ silüetleriyle hareketlendirilmiştir.</p>			

Adı Soyadı	Tarih	İmza
İ.Yasemin ÖZLÜK	23.01.2012	

